

# *Owner's and Installation manual*

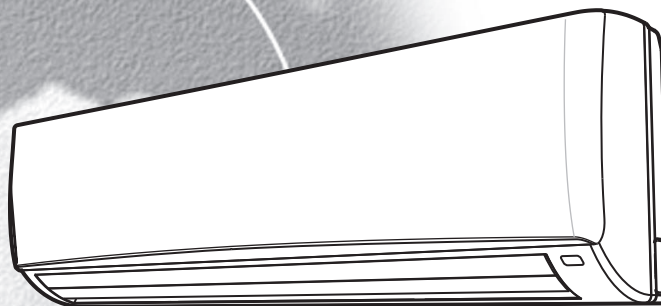

## **SPLIT SYSTEM AIR CONDITIONER**

### **P5 Series**

- 42XPL030C3P/38XPL030C3
- 42XPL030H3P/38XPL030H3
- 42XPL036C3P/38XPL036C3
- 42XPL036H3P/38XPL036H3



## Thank you for selecting Carrier!

---

You can be justifiably proud of your purchase because the same pride in craftsmanship and engineering know-how that goes into Carrier equipment for cooling the Astrodome sports complex in Texas, the United States Capitol's Halls of Congress and countless other installations worldwide have been built into your unit.

One of the pleasant benefits awaiting you with room air conditioning is that in addition to being cooled, the room air is filtered and dehumidified. This manual is designed to help you be familiar with the many comforts and technological features your unit offers. Moreover, it contains vital information about maintenance, service and economical operation. Take the next few minutes to discover for yourself how to get the most in personal comfort and economical operation from your new Carrier room air conditioner.

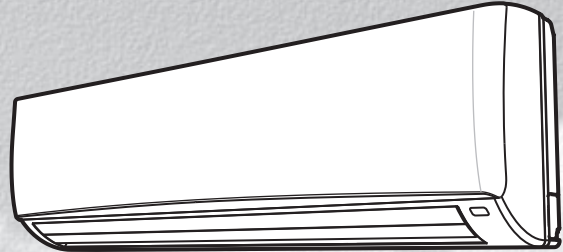

# CONTENTS

<b>PRECAUTIONS</b>	<b>2</b>
--------------------	----------

## **OWNER'S MANUAL**

<b>BEFORE OPERATION</b>	<b>5</b>
<b>UNIT OPERATION</b>	<b>9</b>
GENERAL OPERATION	
AUTOMATIC OPERATION(For Heat Pump Model)	
TIMER OPERATION	
COMBINATION OF ON, OFF AND DAILY TIMER	
SLEEP TIMER	
DISCHARGE AIR LOUVER CONTROL	
AIR CLEANING OPERATION	
<b>CARE AND MAINTENANCE</b>	<b>17</b>
POINTS TO NOTE	
CLEANING THE FILTERS AND FRONT PANEL	
CLEANING THE MAIN UNIT	
AFTER-SEASON CARE	

## **INSTALLATION MANUAL**

<b>STANDARD INSTALLATION ACCESSORIES</b>	<b>20</b>
<b>CHOOSING THE UNIT LOCATION</b>	<b>21</b>
INDOOR UNIT	
OUTDOOR UNIT	

<b>INSTALLATION TIPS</b>	<b>22</b>
<b>INDOOR UNIT INSTALLATION</b>	<b>23</b>
INSTALLING THE WALL HANG BRACKET	
MAKING THE WALL PENETRATION FOR THE INTERCONNECTING PIPING	
INDOOR UNIT WIRING	
FORMING THE DRAIN HOSE AND REFRIGERANT PIPING	
INSTALLING THE INDOOR UNIT BODY TO THE WALL HANG BRACKET	
<b>CONNECTING THE PIPING</b>	<b>28</b>
CONNECTING PIPE TO THE INDOOR UNIT	
CONNECTING THE INTERCONNECTING PIPE TO THE OUTDOOR UNIT VALVE	
<b>AIR PURGE</b>	<b>29</b>
USING THE VACUUM PUMP	
<b>GAS LEAK CHECK</b>	<b>30</b>
<b>FINISHING</b>	<b>30</b>
<b>OUTDOOR UNIT WIRING</b>	<b>31</b>
<b>ELECTRICAL CONNECTION</b>	<b>32</b>
CONNECTING THE POWER SUPPLY	
<b>TEST RUNNING</b>	<b>33</b>
<b>HIGH PRESSURE CONTROL</b>	<b>33</b>
<b>CONFIGURATION</b>	<b>34</b>
<b>PUMP DOWN</b>	<b>35</b>
<b>TROUBLESHOOTING</b>	<b>36</b>

## PRECAUTIONS

### SAFETY CONSIDERATIONS

Installation and servicing of air conditioning equipment can be hazardous due to system pressure and electric components. Only trained and qualified service personnel should install, repair or service air conditioning equipment.

Untrained personnel can perform basic maintenance functions of cleaning coils and filters, and replacing filters. And untrained personnel don't include children and persons who with reduced physical sensory or mental capabilities, or lack of experience and knowledge. They should have been given supervision or instruction concerning use of the appliance by person responsible for their safety. All other operations should be performed by trained service personnel. When working on air conditioning equipment, observe precautions in the literature, tags and labels attached to the unit and other safety precautions that may apply. Follow all safety codes. Wear glasses and work gloves. Use a quenching cloth for brazing and detaching brazed connections. Have a fire extinguisher available for all brazing operations.

#### ▲ WARNING

- Do not install by connecting them to other indoor or outdoor units without consulting a Carrier or other competent air conditioning engineers. Mismatching of the units and incompatibility between control devices in the two units could lead to damage of both unit and voiding of the Carrier warranty. Carrier declines any responsibility, and warranty shall be void if these installation instructions are not observed or if change are made to the electrical connections. Contact your Carrier distributor if you need further help.
- Before performing service or maintenance operations on the system, turn off the main power switches and breaker of the unit. Electric shock may cause personal injury. "If the supply cord is damaged. It must be replaced with a same size BS approved cord or contact Carrier distributor to arrange for replacement."

#### ▲ CAUTION

**TO DISCONNECT THE APPLIANCE FROM THE MAIN SUPPLY.**  
This appliance must be connected to the main by means of a circuit breaker or a switch with a contact separation of at least 3 min. Check that all current national safety code requirements have been followed for the installation. In particular ensure that a properly sized and connected ground wire is in place.

#### ▲ WARNING

Do not switch off the split system by disconnecting the electric power supply. The unit must always be switched off using the remote control.

#### ▲ WARNING

Check that the impedance of the mains power supply is in conformance with the unit power input indicated in the electric data table, on page 32.

#### ▲ CAUTION

The mains supply must be connected to the outdoor unit.

## PRECAUTIONS

### ▲ WARNING

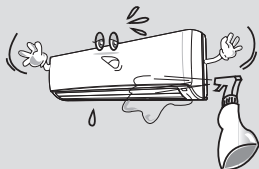

To avoid the risk of serious electric shock, never splash the indoor and the outdoor unit with water.



Use the correct voltage.  
Using voltage other than specified will damage the unit.

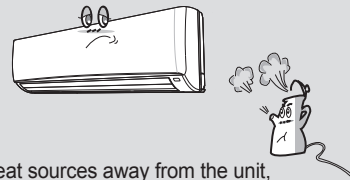

Keep heat sources away from the unit, high temperature can cause damage.

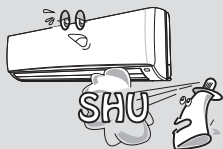

Do not use flammable sprays near the unit. The unit can be damaged by gasoline, benzene, thinner, insecticide and other chemical agents.



Use only fuses of the proper amperage.



Do not use circuit breaker as a means of turning off the unit. The unit must always be switched off using remote control.

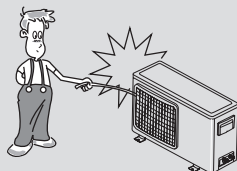

Do not put hands or objects into the discharge grille of outdoor unit. This unit has a fan running at high speed. It is very dangerous to touch the fan.



Do not obstruct the front of the discharge grille of both units. This will block air flow, reduce the cooling effect and may result in unit malfunction.



In summer, if possible, prevent direct sunlight from entering the room; draw curtains or blinds.

## PRECAUTIONS

### Standard Safety Instructions for Air-Conditioning Units

The air conditioner is not intended for use by young children or special needs persons without supervision by a person that is responsible for their safety.

Young children should be supervised to ensure that they do not play with the air conditioner.

Wiring connections must be secured tightly and the cable should be routed properly to avoid the risk

Don't use a damaged power cord , or loose socket as it may cause fire or electrical shock

Do not place the power cord near the heater

Install the panel and cover the control box securely

Do not touch the unit with a wet hand , there is a risk of Electric Shock

Do not place anything on the power cable , there is a risk of fire and Electric shock

Two or more people should lift and transport the product and use proper Safety precautions while lifting the product to avoid personal injury.

Always check for gas leakage after installation or repair of product

### Indoor Unit Display

- ① Ioniser(Left) light : illuminated during Ioniser activated.
- ② Timer(Middle) light : illuminated during timer mode.
- ③ Power(Right) light : illuminated during operation.
- ④ EMER. button

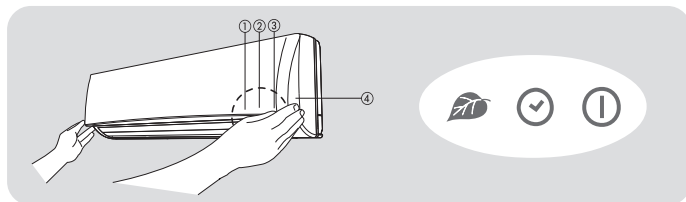

### Test Operation

This operation is used for checking after unit installation.

- Press the EMER. button continuously during 5~10sec. And then unit will be operated as test mode.
- Press the EMER. button once more after checking to activate the remote control. If there is any input signal ( remote control signal or EMER. button press ) during test operation, the TEST mode will change to the input signal mode.
- The setting conditions of the test operation are as follows:
  - Operation mode : COOL
  - Fan speed : HIGH
  - Timer mode : Disable
  - Discharge air direction : SWING

### Emergency Operation

When the remote control is lost, damaged or the battery is discharged, the EMER. button can be used to run the unit.

- Press the EMER. button once briefly at the off mode condition shorter than for 5 sec.
  - According to the room temperature, the unit operates the Cool mode in cool only model and the Auto mode in Heat pump model.
- If you want to stop the emergency operation, push the EMER. button again or operate the remote control.
- The setting conditions of emergency operation are as follows:

Model	Operation	Preset mode	Fan speed	Timer mode temperature	Discharge air direction
Cooling only	COOL	24°C	AUTO	Disable	Horizontal
Heat Pump	AUTO	25°C	AUTO	Disable	Preset location according to 'Cool' or 'Heat' mode

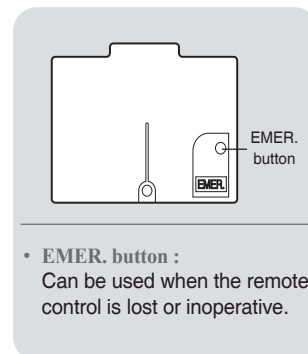

## BEFORE OPERATION

### Replacing Batteries

- 1 Remove the cover of the battery compartment at the back of the remote control by sliding it out in the direction of the arrow.

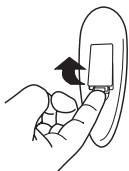

- 2 Remove the used batteries and insert new batteries. The remote control uses two batteries.(1.5V(L)R03x2)

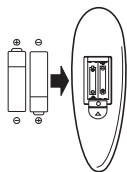

- 3 Press reset button with a sharp object if the remote control is not operating properly or after replacing the batteries.



#### NOTE

- Changing batteries should be done after turning off the unit.

### Setting Current Time and Reset

- 4 With the remote control On or OFF, press button C for more than 5 seconds
- 5 The current hour figure flashes. Press either button  $\wedge$  or  $\vee$  to set the current hour. Press button C to move to minutes and set them.
- 6 For this setting always use either button  $\wedge$  or  $\vee$ .
- 7 Once the current time is set, press button C to confirm it.

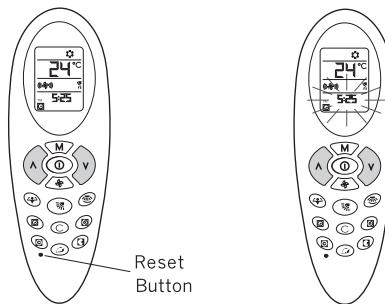



## BEFORE OPERATION

### Matching Address between Indoor Unit and Remote Control

When two units are used in the same room, you can match the address of the remote control to that of the unit.

### Indoor Unit

Refer the page 35.

### Remote control

Refer the page 34.

### NOTE

- This function must only be performed by qualified service personnel.

### Signal Receiving

Use the remote control where its signals can reach the receiver of the air conditioner. (A distance of 5m is allowed)

- You can hear a beep from the unit which indicates that the signal is received.

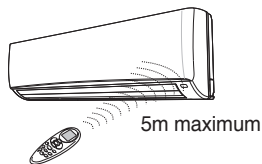

### CAUTION

- The air conditioner will not operate if curtained, doors or other materials block the signals from the remote control to the unit.

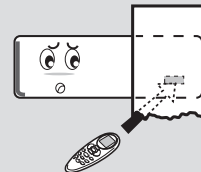

- If the infrared signal receiver on the unit is exposed to direct sunlight, the air conditioner may not work properly. Draw the curtains to avoid direct sunlight.

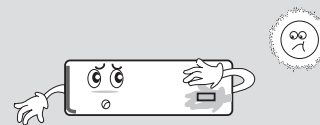

- A mounting bracket for the remote control is supplied with the unit. Install the mounting bracket on the wall where the remote signal can be easily received from the remote.

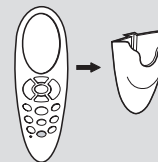

- If the room using the air conditioner has fluorescent lighting with electronic starter, signals may not be properly received. If you are planning to use such fluorescent lamps, consult your local dealer.

## BEFORE OPERATION

### Remote Control Display

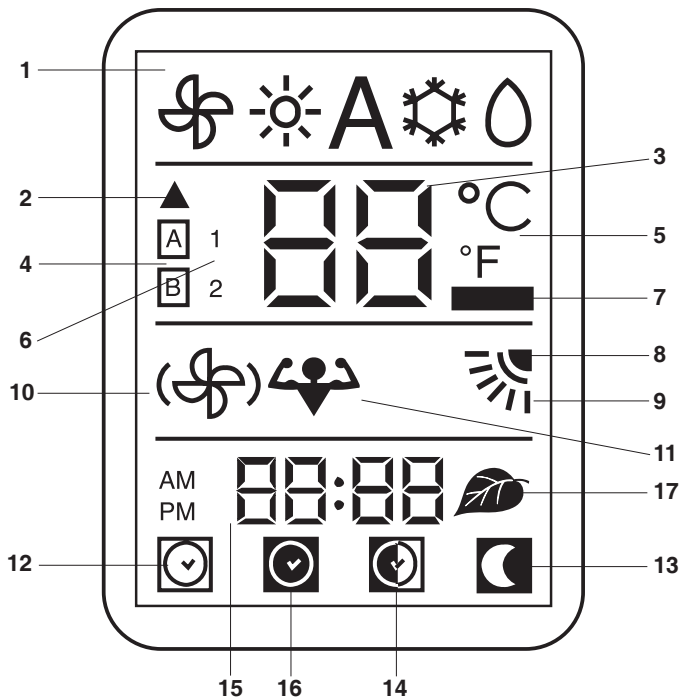

1. Operating mode (from left to right):
  - Ventilation (fan only)
  - Heating (heat pump models only)
  - Automatic (heat pump models only) A
  - Cooling and dehumidification
  - Dehumidification only
2. Signal transmission symbol
3. Temperature selected
4. Address selector
5. Temperature unit of measurement (°C or °F)
6. Unit configuration
7. Batteries exhausted indicator
8. Vertical louver swing indicator
9. Louvre positioning (Flap)
10. Fan speed
11. Turbo mode
12. ON timer selected
13. Night timer active
14. DAILY timer active (Everyday)
15. ON timer, OFF timer and current time
16. OFF timer selected
17. Ioniser active

# UNIT OPERATION

## GENERAL OPERATION

### PROCEDURE

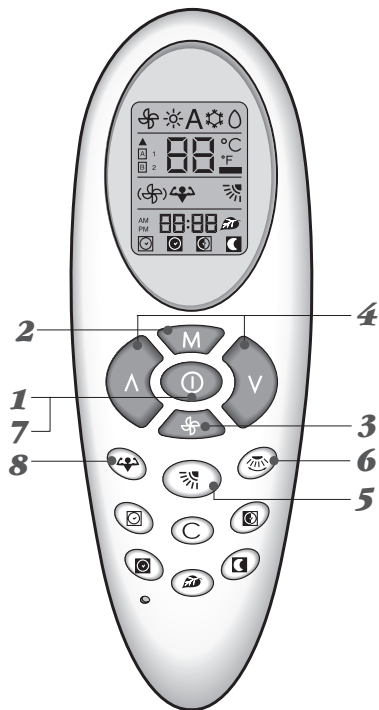

**1 ON/OFF button** .....  
Press this button and the COOL (AUTO for Heat Pump Model) operation is indicated.

- A receiving beep is heard.
- The green UNIT ON lamp of the indoor unit display illuminates.

**2 MODE button** .....  
Press this button to select the desired operation.

⚙️ (COOL) → 🌀 (FAN) → ⦿ (DRY) For Cooling Only Model.

A (AUTO) → ⚙️ (COOL) → ⦿ (DRY) → ☀️ (HEAT) → 🌀 (FAN) For Heatpump Model.

**3 FAN SPEED button** .....  
Press this button to select the desired fan speed.

(🌀) (AUTO) → (🌀) (LOW) → (🌀) (MED) → (🌀) (HIGH)

**4 TEMP.(Λ V) button** .....  
Press these buttons to set the desired temperature.

**5 HORIZONTAL LOUVER button** .....  
Press this button to control the desired air flow direction up and down.

**6 VERTICAL LOUVER button** .....  
Press this button to control the desired air flow direction to the left and right side.

**7 ON/OFF button** .....  
Press this button to stop the unit operation.

- A receiving beep is heard.
- The UNIT ON lamp is extinguished.

**8 TURBO MODE button** .....  
Press this button to quickly cool down the indoor temperature.

### NOTE

- Dry operation eliminates moisture economically by operating the compressor, indoor and outdoor fan motor intermittently, so that the room temperature is maintained at the set temperature.

# UNIT OPERATION

## AUTOMATIC OPERATION (For Heat Pump Model)

Automatic operation means that the air conditioner operates automatically by selecting the COOL or HEAT mode and automatically changes the fan speed according to the indoor condition to keep the room temperature comfortable.

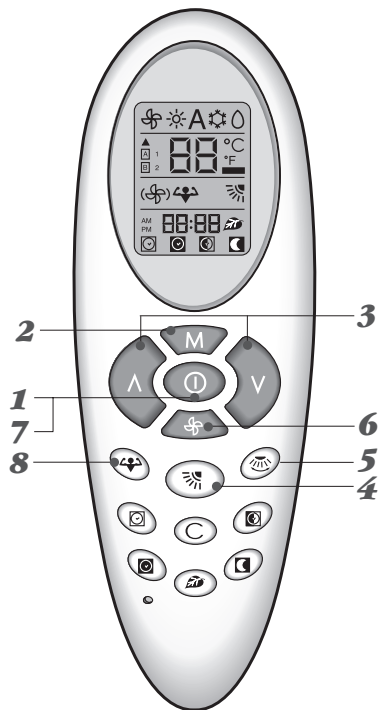

### PROCEDURE

- 1 ON/OFF button** .....  
Press this button and the unit starts AUTO operation.
- 2 MODE button** .....  
If the unit is operating in another mode, press the MODE button to select Auto.  
A(AUTO) → ⚙(COOL) → ∅(DRY) → ☀(HEAT) → 🌀(FAN) For Heatpump Model.
- 3 TEMP.(▲ ▼) button** .....  
Set the desired temperature using the remote control buttons. At the start of the AUTO operation, the temperature is set at 25°C and it is functional within the total temperature range.
- 4 HORIZONTAL LOUVER button** .....  
Press this button to control the desired air flow direction up and down.
- 5 VERTICAL LOUVER button** .....  
Press this button to control the desired air flow direction to the left and right side.
- 6 FAN button** .....  
Set the desired fan speed. At start up, fan speed is set to AUTO.
- 7 ON/OFF button** .....  
Press this button again to stop operation.
- 8 TURBO MODE button** .....  
Press this button to quickly cool down and heat up indoor temperature.

### NOTE

- When the room temperature is between 21°C ~ 29°C.
  - If the room temperature is lower 1°C or more than the set temperature : HEAT mode will be operated.
  - If the room temperature is higher 1°C or more than the set temperature : COOL mode will be operated.
- When the room temperature is lower than 21°C or higher than 29°C, the operation mode is restricted regardless of the set temperature.
  - If the room temperature is lower than 21°C then only the heating mode is allowed.
  - If the room temperature is higher than 29°C then only the cooling mode is allowed.
- The Auto operation is not suitable for the application to the computer room or some food/wine stock storage.

## TIMER OPERATION

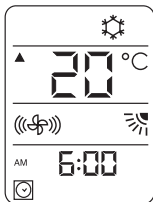

### ON timer procedure





- 1 ON TIMER button**  .....



Press this button, even if the remote control is OFF. The relevant icon and time figure will start to flash. If 10 seconds have elapsed and no button is pressed, the remote control turns OFF (if it was already OFF when button  was pressed) or timer function automatically deactivates.
- 2 HOUR, MINUTE buttons (buttons  $\wedge$  and  $\vee$ )** .....





If the unit is ON, the only possible selection is the start-up time.  
The unit will operate with the selections shown on the display.
- 3 HOUR, MINUTE button (buttons  $\wedge$  and  $\vee$ )** .....

If the unit is OFF: to select the start-up time, use the temperature control buttons (buttons  $\wedge$  and  $\vee$ ). First select the hours and, after have confirmed these by pressing button , select the minutes using either button  $\wedge$  or  $\vee$ .  
To definitively set the time, press button  again.
- 4 Operating mode** .....

Choose the unit operating mode. The icons will flash. To select the mode, use the button **M**.  
Once the mode has been decided, press button .  
The icon of the selected mode will stop flashing.
- 5 Desired temperature** .....

To select the desired temperature, the value is flashing, use either button  $\wedge$  or  $\vee$ .  
Push button , to confirm the selection. Numbers will stop flashing.
- 6 Fan speed** .....

Choose the fan speed, using button . When the selection has been completed, press button  for confirmation. The icon will stop flashing.
- 7 Louver positioning** .....

Now this icon is flashing. Use button  and , to select desired position.  
Press button  for confirmation. Now all icons are fixed on display.  
If you want to cancel selections up to here inserted, push button **C** ;  
if you want to cancel all options once timer has been set, push button  and then **C** .





## UNIT OPERATION

### About the ON Timer

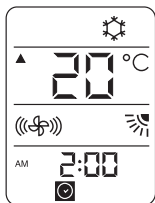
- When the ON Timer function is operating, the unit senses the room air temperature right before the start-up time.
- If you want to warm or cool the room at desired time, set the timer 30 minutes earlier than start time.

### OFF timer procedure



- 1 OFF TIMER button**  .....  
Press button  . The OFF timer icon and numbers for time selection are flashing. This function can be set even if the remote control is OFF.
- 2 HOUR/MINUTE selection button (buttons  $\wedge$  and  $\vee$  )** .....  
To set the clock time, press either button  $\wedge$  or  $\vee$  .  
To move from hour to minute, press button  . Press button  again to confirm.



### NOTE

- If you reserve the ON Timer during operation, the unit will be operated continuously.

## Combination of ON, OFF and DAILY Timer

### Procedure

#### DAILY timer

Push the button  when the ON or OFF timer is active. The icon will appear on display. In this way the ON and OFF timer memorization will be repeated every day. To disactivate the daily function, press again the button .

#### Combination of ON, OFF and DAILY timer procedure

If you want operation to start at 5.30 p.m. and stop at 10.30 p.m., proceed as follows:

**1** Select ON timer at 5:30 p.m.

**2** Select OFF timer at 10:30 p.m.

**3** Select the desired operating mode (button **M**).



If you want to stop operation at 10:30 P.M. and start again at 7:30 A.M. with the same operating mode, proceed as follows:

**1** Select OFF timer at 10:30 p.m. during operation

**2** Select ON timer at 7:30 A.m.



If you want Everyday operation to start at 5.30 p.m. and stop at 10.30 p.m., proceed as follows:

**1** Select ON timer at 5:30 p.m.

**2** Select OFF timer at 10:30 p.m.

**3** Press the everyday button (daily button ).



#### Cancellation of ON, OFF and DAILY timer procedure

If you want to cancel On or OFF timer setting, press the following buttons in sequence:

- button  or 
- button **C**.

To deactivate the Everyday function, press button . The Everyday function will remain operative until one of the two timers (ON or OFF) is active.

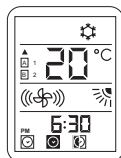

### NOTE

- In the ON and OFF Timer operation, the earlier setting compared to the current time will be applied first.
- The DAILY Timer can be selected in case of a combination of the ON and OFF Timer reservation. Daily timer is not available for sleep timer mode.
- You can change the ON/OFF reservation time during the DAILY Timer reservation.
- When the electricity fails while DAILY Timer is reserved, DAILY Timer reservation will be canceled. Reserve the DAILY Timer again after the electricity comes on.
- The TIMER lamp of the indoor unit will be on if either the ON Timer or the OFF Timer is reserved.

# UNIT OPERATION

## Sleep Timer

### Sleep timer procedure “night”

Press this button to set the SLEEP timer with remote control on. The icon will appear on the display.

This procedure permits setting the remaining unit operating time.

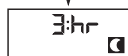
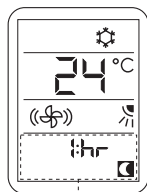

**1** “1:hr” will be displayed together with the icon.

**2** Press button  $\Delta$  (temperature increase).  
The display will show the following settings in sequence:  
1 hr, 2 hr, 3 hr, 4 hr, 5 hr, 6 hr, 7 hr, 8hr and 9 hr.

**3** Once the remaining operating hours have been selected with either button  $\Delta$  or  $\nabla$ , again press button  to confirm.

**4** When the SLEEP timer is set, the unit will control the set temperature to avoid overcooling or overheating during operation. Also indoor fan operates at low fan speed regardless of user selection.

The set temperature will change as follows:

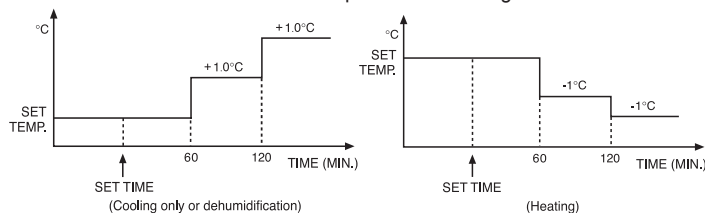



### NOTE

- When the SLEEP timer is set, the luminosity of the unit lamps will be dimmed so as not to interrupt sleep.
- The SLEEP timer can be combined with the ON timer.

## Turbo mode and Ioniser function

### Turbo mode button

If you want more powerful capacity at Cooling and Heating mode, press button . On the display, the powerful icon  will start flashing.

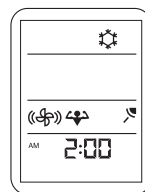

### 1 Turbo mode at Cooling mode

Performs the powerful cooling operation until room temperature reach 17°C or 20 minutes after pressing turbo mode button.

At this mode, indoor fan speed is high and compressor speed is over rating speed in order to obtain maximum cooling capacity.

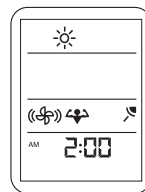

### 2 Turbo mode at Heating mode

Performs the powerful heating operation until room temperature reach 32°C or 20 minutes after pressing turbo mode button.

At this mode, indoor fan speed is high and compressor speed is over rating speed in order to obtain maximum heating capacity.

During Turbo mode, you cannot control room temperature, and fan speed. press one of the buttons **M** or  to cancel the turbo mode.

### Ioniser function button

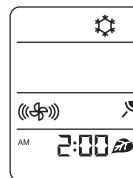

**1** Press Ioniser button  to activate Ioniser function during unit ON.

**2** Press Ioniser button  again to stop Ioniser function.



# UNIT OPERATION

## DISCHARGE AIR LOUVER CONTROL

### Up and Down Control

The air discharge direction can be controlled to swing up and down and can be fixed at a preferred position or at automatic position by the remote control.

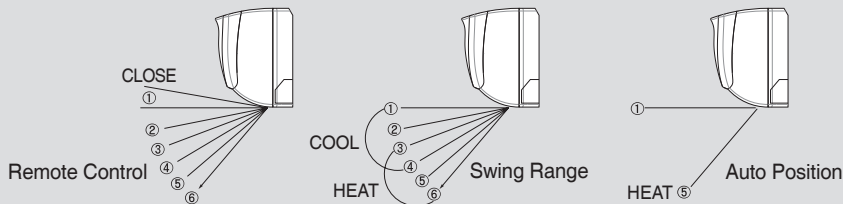
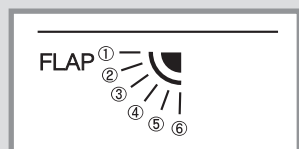

- If you select the flap position using the FLAP button in the remote control, the flap in the unit will move to that position automatically. Once you select the position, the unit remembers that position and whenever you turn on the unit, the flap will be positioned to that position.
- If you select SWING, the flap will swing up and down. In the COOL, DRY and FAN mode, the flap will swing in the cool range. In the HEAT mode, the flap will swing in the heat range.
- If you select AUTO, the flap will position itself to the preset position according to the operation mode.

### NOTE

- Always use the remote control to adjust the flap position, otherwise it may cause abnormal operation. Please turn off the unit and turn it on again when you manually adjust the flap out of range.

### Left and Right Control

If you want to adjust the direction of the discharge air left or right, Pressing the 'vertical louver' button. The button will set the swing on and off.

### NOTE

- Please do not fix the flap at position ⑥ for a long time, because this position minimizes air circulation resulting in uneven room temperature.
- Do not adjust the flap by the hand during SWING operation because it may damage the air swing mechanism.
- If you want maximum cooling or heating capacity, please set flap at position ④.



Vertical louver button

Horizontal Louver setting 6 and Vertical Louver Swing Indicator		
Time	1sec	1sec
Swing on		
Swing off		

## UNIT OPERATION

### AIR CLEANING OPERATION

#### Information for filters

- Filters
  - Standard Air Filter
  - Optional Filters (3 items available)
    - ① Active carbon filter
    - ② Photo catalytic filter
    - ③ Triple filter
- Standard air filter eliminates dust and lint.
- Active carbon filter is particularly effective in eliminating odor.
- Photo catalytic filter effectively eliminates cigarette smoke in the room air.
- Triple filter (nano silver filter + vitamin filter + anti mite filter) deodorizes ammonia, formaldehyde, toluene, and provides powerful anti-bacterial effect.

#### Life time of filters

- The life of above filters varies according to the amount of air pollutant, room size and the operating time.
- Standard can be cleaned with a vacuum cleaner or rinsed under running water after using a month.
- The life time of Active carbon, Electrostatic, Photo-catalytic filter is about 3 months.  
Please replace them with new one every 3 months.

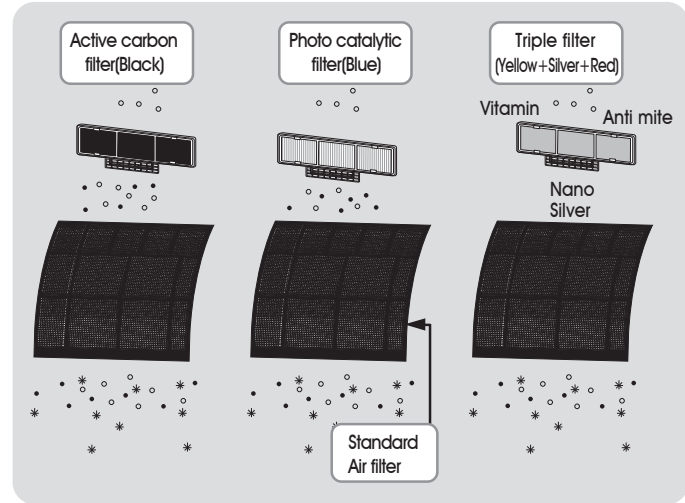

### HOME AUTOMATION FUNCTION (optional)

- In case of fire, remote ON/OFF switching of the system is possible. In addition, the ON/OFF switching through the remote control can be locked.
- However, an adaptor and wiring connected to the central control room is necessary in the field when this function shall be feasible.

## POINTS TO NOTE

### Operating Condition

- Temperature ranges suitable for unit operation are as follows.

Mode	Indoor (All Market)	Outdoor		
		Asia & Australia	Middle East	Saudi Arabia
COOL&DRY	21 ~ 32° C	21 ~ 43° C	21 ~ 52° C	21 ~ 52° C
HEAT	Below 27° C	-10~24° C	-10~24° C	-10~24° C

- When the unit operates above or below these conditions for a long time, system diagnostics may detect a malfunction and the unit will not operate properly.
- If the unit operates for a long time under abnormal situation of extremely high humidity, condensed water may drip from the unit.

### Time Delay

- If the operating mode changes from COOL and DRY to HEAT, there will be 3 minutes~3 minutes 15 sec time delay between compressor turning off and turning on including starting the heat operation.
- If the operating mode changes from Heat to Cool and Dry, there will be 3 minutes~3 minutes 15 sec time delay .
- When heating operation starts, hot air delivery might be delayed due to a warm up period.

### Minimum Operation Time

- In normal operation, there is a minimum operation time of 3 minutes between compressor turning on and turning off.

### Defrost Operation (For Heat Pump Model)

- In the heating mode, when the outdoor coil is frosted, the indoor fan and outdoor fan will turn off while the compressor will turn on to remove the frost on the outdoor coil.
- The defrost mode stops after 5 minutes 20 sec or 9 minutes 40 sec according to outdoor coil status or when compressor operates according to preset condition.
- When the power is off, the defrost operation is automatically conducted to eliminate frost accumulation on the outdoor coil.

### Auto recovery Operation (Field selection)

- When the electricity fails while the unit is operating, the unit memorizes the operating condition, and it will start operation automatically when the electricity is restored.
- When you leave home during an electricity failure, please unplug the power cord, or the unit will automatically restart in your absence.
- This function is field selectable by pressing the 'Remote' button upto field requirements. Default from the factory is to have this function but it can be selected.(Refer the page 35)

### Frost Prevention of Indoor Unit

When the unit operates at a low ambient temperature, frost may appear on the indoor coil. When the indoor coil temperature is below 0°c, the microcomputer makes the compressor stop to protect the unit from frost.

### Normal Operation

Any of the following can occur during normal operation:

- A sound like a "GURGLE" can sometimes be heard during operation or when the unit stops.
  - It is the sound of the refrigerant flowing through the unit.
- Bad smells can come from the unit.
  - Smells such as smoke or cosmetics can accumulate while room air circulates through the unit.
  - Cleaning the filters will reduce this problem.
- UNIT ON lamp on the indoor unit displays flashes and no air comes from the unit.
  - It indicates malfunction of the unit and the compressor will stop operating.
- A "BAK-BAK" sounding noise can sometimes be heard during operation or when the unit turns on.
  - It is the sound of plastic expanding due to an abrupt temperature change.

## CARE AND MAINTENANCE

### CLEANING THE FILTERS AND FRONT PANEL

#### Cleaning the Air Filter

- 1** Lift the front panel and pull the air filters downward.

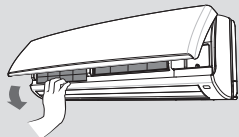

- 2** Clean the filters with a vacuum cleaner.



- 3** Rinse the filters under running water, dry completely, and refit correctly into their guides.



#### NOTE

- Turn off the unit and pull out the power plug before cleaning.
- Clean the air filters once a month.

#### Cleaning the Ioniser

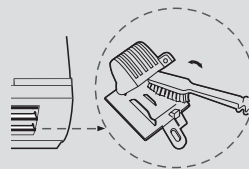

- Clean Ioniser with a brush every three months
  - 1) Unscrew a ioniser and open a cover
  - 2) Rub needle on base of ioniser with brush
  - 3) Tighten up a screw

#### ⚠ WARNING

##### HIGH VOLTAGE!

The unit must be disconnected from the main supply before maintenance or cleaning.

## CARE AND MAINTENANCE

### Washing the Front Panel

- 1** Lift the front panel up to the top of the unit and separate it from the unit.

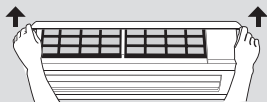

- 2** Rinse the panel under running water and dry completely in a shaded area.

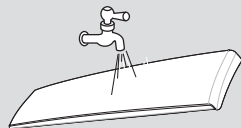

- 3** Refit it correctly. Installation procedure is reverse to the removal procedure.

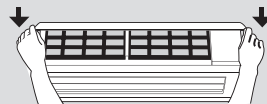

#### NOTE

- Turn off the unit and pull out the power plug before washing.
- Clean the front panel if it becomes dirty and spotted.
- Front panel is removable.

### CLEANING THE MAIN UNIT

- Use only a damp soapy towel.

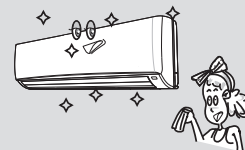

#### NOTE

- When cleaning the unit, first turn it off and pull out the power plug.

### AFTER-SEASON CARE



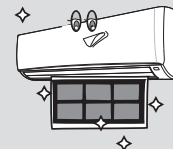

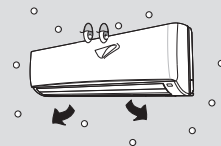

- 1** Clean the filters and refit them into the unit.



- 2** If the unit is to be switched off for an extended period, run the unit on FAN only for two hours to dry inside of the unit.



The following installation accessories are supplied with unit. Use them as required.

Name and shape	Q.ty	Use
Wall hanging bracket 	1	For indoor unit installation
Screws 4xL10 	2	For fixing unit and hanging bracket
Screws 3xL14 	1	For wireless remote control mounting bracket Installation
Screws 5xL25 	14	For wall hanging bracket installation
Wireless remote control mouting bracket 	1	For wireless remote control Installation
Electrostatic filter + photocatalytic filter + Active carbon filter + Triple filter 	1~3	For eliminating microscopic dust and cigarette smoke, in the room air.(optional)

The following field supplied items are required to complete the installation.

Name	Specification	
	Liquid	Gas
Connection pipe	∅ 6.35mm	∅ 15.88mm
Electrical connection cable between indoor and outdoor unit	Cable type : H07RN-F, Synthetic rubber insulation with Neoprene coating, according to IEC 60335-2-40. Refer the Page 32.	
Power supply cable	H07RN-F or higher and refer the Page 32.	
Finishing tape	PVC film	
Others	Wall sleeve, Wall cap, Vinyl tape, Pipe insulation, Sealer putty	

## CHOOSING THE UNIT LOCATION

### 1) Indoor Unit

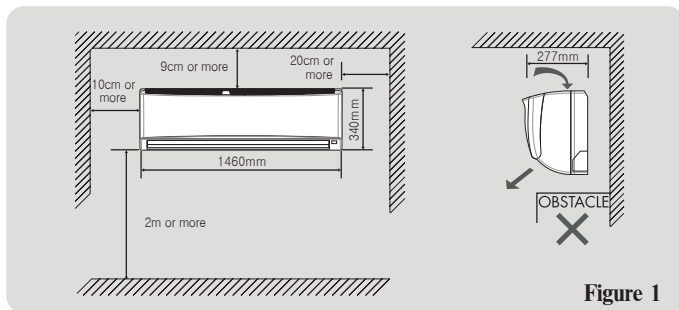

Figure 1

- Leave the space shown in Figure. 1 for servicing or removing the filter and for good air flow and for safety.
- If the room using the air conditioner has fluorescent lighting with electronic starter, signals may not be properly received. Keep the indoor unit away from fluorescent lamp to receive the signal from remote.

#### ⚠ CAUTION

Installation in the following places may cause problem.

If it is unavoidable to use the unit in such places, consult with your distributor.

- A place with an oily ambient.

### 2) Outdoor Unit

- Leave the space shown in Figure. 2 between the unit and any obstruction for good air flow.

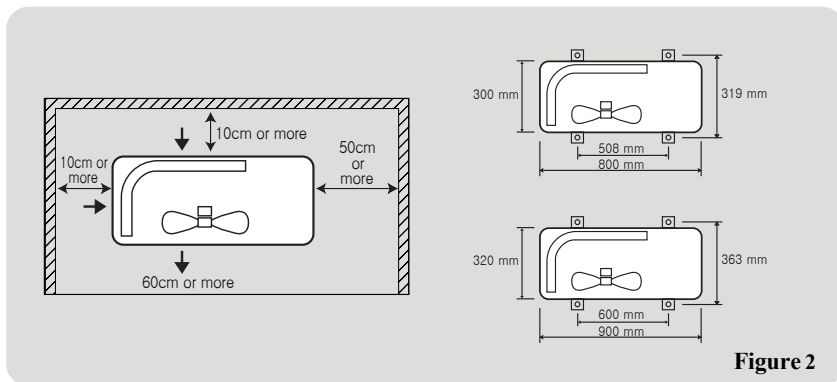

Figure 2

#### ⚠ CAUTION

Installation in the following places may cause problems. If it is unavoidable to use the unit in such places, consult with your distributor.

- A place with machine oil.
- A saline place such as a seashore vicinity.
- A place with sulphur gas.
- A place where high-frequency waves are generated by radio equipment, welders, and medical equipment.

## INSTALLATION TIPS

The following points should be avoided.

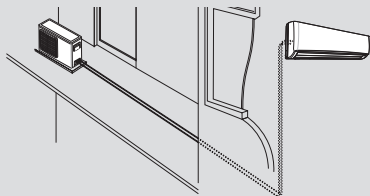

Excessive distance between the indoor and the outdoor unit. (Max 40m)

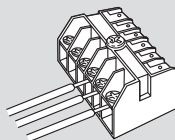

Slack connections on the electrical cables for cooling only model & heat pump model.

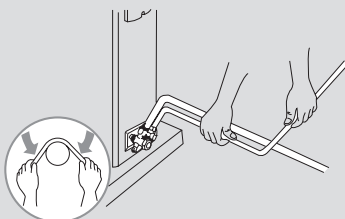
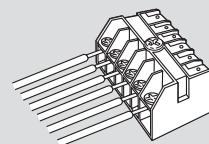

Kinking the connection pipes.

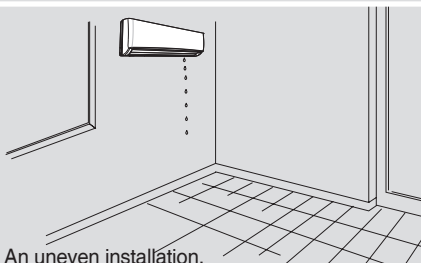

An uneven installation.

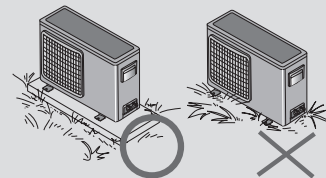

Do not install the outdoor unit on grassy or soft surfaces. ( Unit must be level. )

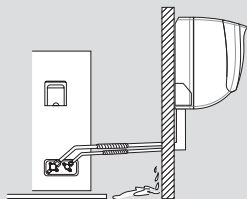

Dripping due to insufficient insulation of pipes.

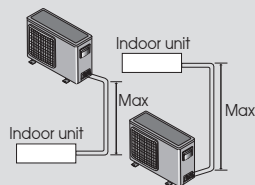

Excessive height between the indoor and the outdoor unit. ( Max 20m )



## INDOOR UNIT INSTALLATION

- The piping can be connected to the four directions indicated by ①, ②, ③, ④. When the piping is connected to the direction of ①, ② or ④, detach the knock-out either at the side or at the bottom of the unit. ( Fig. 3 )

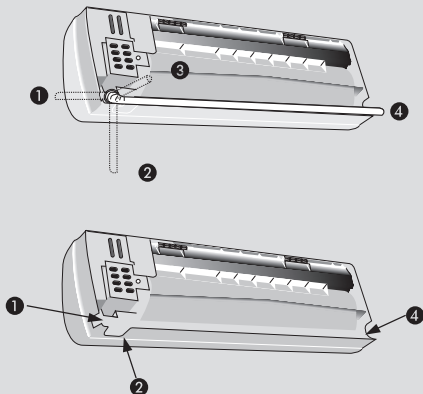

Figure 3

### 1) Installing the Wall Hang Bracket

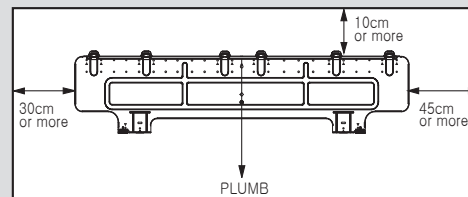
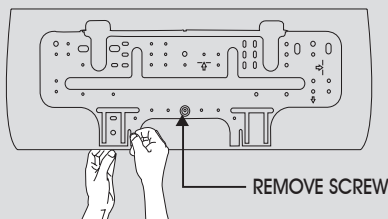

Figure 4

- Install the wall hang bracket so that it is level. Use a plumb line if necessary. ( Figure. 4 )
- Be sure to leave the clearance spaces shown in Figure 1.
- Before installing the wall hang bracket, remove it from the unit by pushing up marks (▲) at the bottom of the body.
- Fasten the wall hang bracket to the wall with 14 or more self-tapping screws through the holes marked “▲” at the wall hang bracket.
- Install the wall hang bracket so that there is no gap between the bracket and the wall.
- Check that the wall hang bracket does not move to prevent noise during operation.

#### NOTE

- In case of removing the unit from the wall hang bracket after installing it onto the wall, remove by pushing up MARKS (▲) at the bottom of the body.

## INDOOR UNIT INSTALLATION

### 2) Making the Wall Penetration for the Interconnecting Piping

#### Rear Piping

- It is best for the piping to go through the wall behind the unit. So that the unit hides the pipes.
- For this method of installation, make a 65mm diameter hole in the wall at either point L or R. ( Figure. 5 )

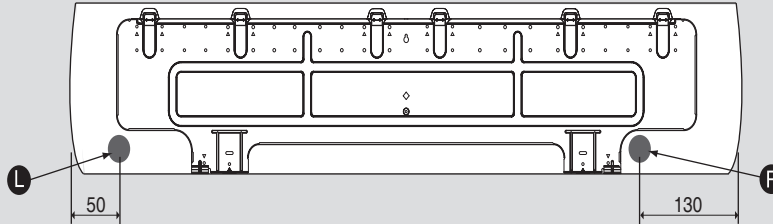

Figure 5

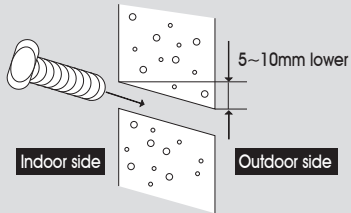

Figure 6

- Drill a hole at a slope so that the outside end is lower ( 5-10mm ) than the inside end to ensure good drainage.
- Cut the Wall Sleeve to match the wall thickness and to pass the pipe through the hole. ( Figure. 6 )

#### Side or Bottom Piping

- Remove the knock-out in the unit and pass the pipes through the wall.
- The pipe should slope downward and away from the unit to ensure good drainage.

## INDOOR UNIT INSTALLATION

### 3) Indoor Unit Wiring

- Lift the front panel up to the top of the unit and then it will be separated from the unit.
- Detach the Terminal block cover and clamp wire. ( Figure. 7 )
- Connect the electrical connection cord with the screws to the terminal block of the indoor unit as described at Figure. 8.  
( Refer to the Wiring Diagram inside the Frame grille and Caution Label on the frame grille. Caution Label is engraved on Frame grille )
- Reinstall the clamp wire and the terminal block cover with the screws after wiring.
- Fit the front panel to the latch of the Frame grille.

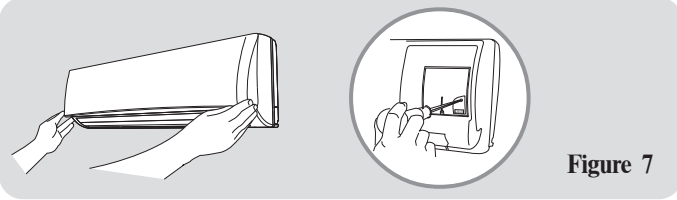
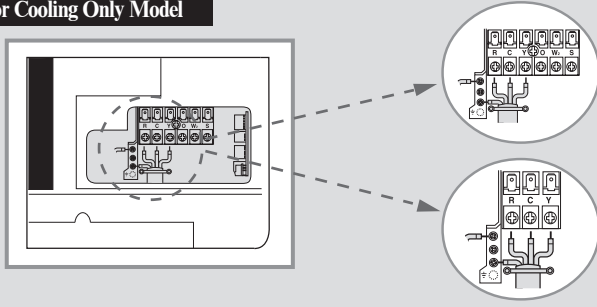

Figure 7

#### For Cooling Only Model



#### For Heat Pump Model

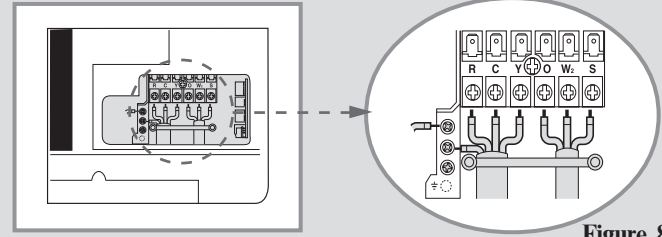

Figure 8

#### ▲ CAUTION

- Do not connect wires when power is ON.
- The air conditioner always requires grounding. Ground the unit must be in accordance with local codes.
- Every wire must be connected firmly. Use connection cable H07(H05, A07, A05)RN-F 1.5mm<sup>2</sup>, synthetic rubber insulation with Neoprene coating, according to EN(IEC) 60335-2-40 and HD277.S1 standards.
- Wrong wiring causes malfunction of the unit and electric shock. Check local electrical codes and also any specific wiring instructions or limitation.
- During installation, proceed first with refrigerant connections between indoor and outdoor units, and only then make the electrical ones; similarly, when disassembling, disconnect the electrical wiring first and only then open refrigerant connections.
- Unit must be installed according to applicable national installation standards.

## INDOOR UNIT INSTALLATION

### 4) Forming the Drain Hose and Refrigerant Piping

- Drain hose and drain cap are assembled as shown in figure 9 in the factory. To do right-side(①), right-bottom(②) or right-back(③) piping in figure 3, draw the drain hose to right-side piping direction.(It is not necessary to exchange the location of drain hose and drain cap.)
- Tie the refrigerant pipe, the drain hose, and the electrical connection cord together.
- Form the refrigerant piping in the required direction, and bind the drain hose and the electrical connection cord together with vinyl tape. The drain hose should be at the bottom. ( Figure. 10 )

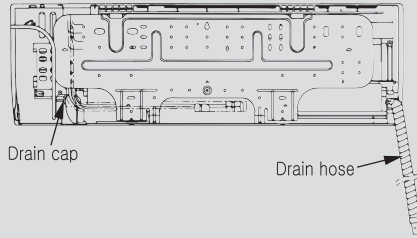

Figure 9

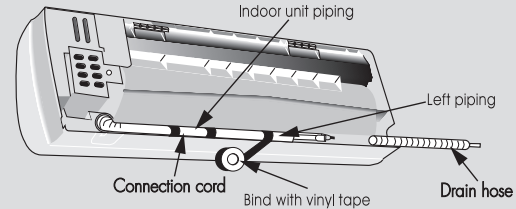

Figure 10

- For Left Piping, fit the pipes and the wiring into the recess at the back of the unit as shown in Figure 11.

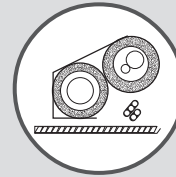
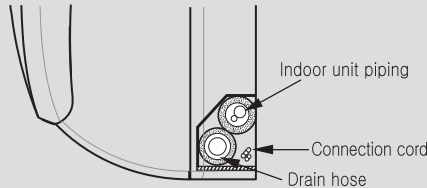

Figure 11

### 5) Installing the Indoor Unit Body to the Wall Hang Bracket

- Pass the pipes through the wall sleeve and then hook the indoor unit body onto the top of the wall hang bracket. ( Figure. 12 )
- For Left Piping, hang the unit onto the top of the wall hang bracket and incline the unit using a tool such as a screw driver set between the middle area of body and bottom right of the wall hang bracket. Connecting the pipe can be done more easily if the unit is inclined.
- Snap the marking places of the body(A, B) onto the hole of the bracket.

## INDOOR UNIT INSTALLATION

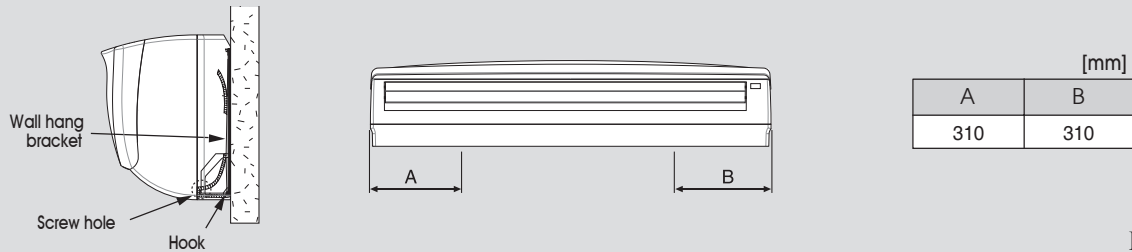

Figure 12

- Next, check the drainage of the unit by pouring some water into the unit drain pan and ensure that the water drains out through the drain hose and that there is no leakage from the other parts.
- After installation, if there is a significant gap between the unit and wall, it can be adjusted by securing 2 screws to the body and wall hang bracket. Refer to the screw hole location(A, B) in Figure 12.
- Removing the frame grille ; ① Detach terminal block cover by removing two screws and remove two screws from frame grille.  
② Pull the triangle marks located at the bottom of the frame grille and lift frame grille to the top of the unit.

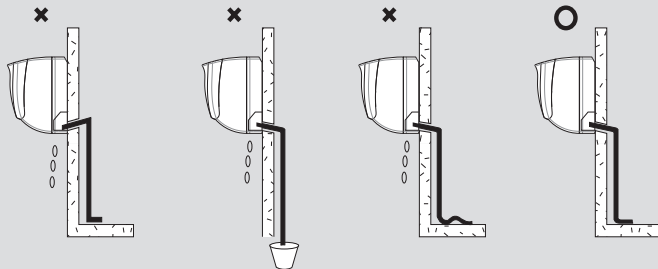

Figure 13

### NOTE

- The recommended bending of the drain hose is shown in Figure 13.

## CONNECTING THE PIPING

Pay careful attention to the following points when installing the refrigerant pipes.

- Hold the pipe with one wrench while tightening the connections with a torque wrench or double-ended wrench.

Be careful not to damage the flare nut threads.

- If the tightening torque is insufficient, gas will leak from the connection.
- If it is too strong, the flare will be damaged.

Tighten the nut with the torque shown in Table 1.

Table 1

Flare nut	Tightening(kgf-cm)	Torque(Nm)
6.35 mm (1/4")	180	18
12.7 mm (1/2")	560	55
15.88 mm (5/8")	660	65
19.05 mm (3/4")	1020	100

- Do not bend the pipe more than three times at one place.
- When extending the rolled pipe, straighten the pipe by unwinding as shown in Figure 14.

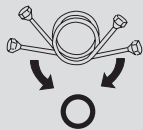

Figure 14

### 1) Connecting Pipe to the Indoor Unit

- Remove the indoor pipe flare nut. ( Check that there is no debris inside. )
- Align the center of the flare surface, and tighten the indoor pipe union and connection pipe flare nut with a torque wrench or double-ended wrench. ( Figure. 15 )

While aligning the center of the flare surface, tighten the nut by hand, hold the union side with a wrench and tighten the nut according to the specified tightening torque with a torque wrench.

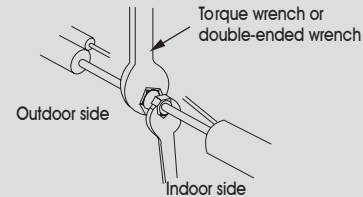

Figure 15

### 2) Connecting the Interconnecting Pipe to the Outdoor Unit Valve

- Repeat the procedure for flaring the tube to connect to the outdoor unit.
- Tighten the flare nut of the connection pipe at the outdoor unit valve. ( Figure. 16 )

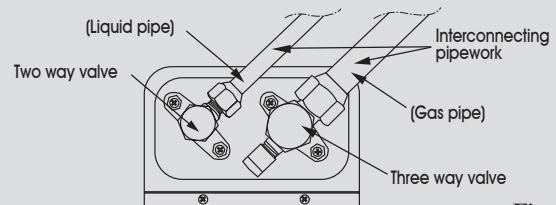

Figure 16

## Using the vacuum pump

For air purge, evacuate the air in the connecting pipe and indoor unit by using vacuum pump. For details, please refer to the following procedure.

- a. Connect the gauge manifold.
- b. Open the low pressure valve and close the high pressure valve of the gauge manifold completely.
- c. Operate the vacuum pump during at least 20 minutes until the pressure reaches -101Kpa (-760mm Hg).
- d. Close the low pressure valve of the gauge manifold and stop the vacuum pump operation. (If the indicator of gauge manifold is returned within 1-2minute after stopping the vacuum pump, check the piping connection leakage)
- e. Open both the two-way and three-way valve completely.
- f. Close both the two-way and three-way valve caps completely.
- g. Remove the gauge manifold and vacuum pump. (During the disconnection, please be cautious not to lose any refrigerant and oil)
- h. Reinstall the valve caps and service port nuts.

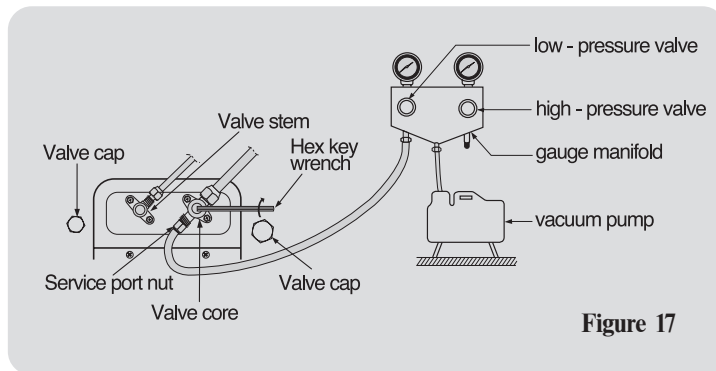

Figure 17

### CAUTION

#### Refrigerant charging

- In case of refrigerant charging due to refrigerant leak or service refer to the nameplate on the outdoor unit.
- When the upward gas line is long, oil trap shall be installed every 10m in order to return oil to compressor.

When the connection pipe is less than 7.5m, extra amount of refrigerant per meter (If it is impossible to extract proper amount of refrigerant, please keep 7.5m piping length by making loops or winding for compressor reliability)

Connecting pipe Size	Extra charge amount	Example for 14.5m pipe
ø15.88mm	45 g/m	$(14.5 - 7.5) \times 45 = 315 \text{ g}$
ø19.05mm	60 g/m	$(14.5 - 7.5) \times 60 = 420 \text{ g}$

Note that the shorter connection pipe, the better the performance of system.

The maximum allowable length of the connection pipe is 40m and the maximum allowable elevation between indoor unit and outdoor unit should be less than 20m.

## GAS LEAK CHECK

After connecting the pipe, check the joints for gas leakage with gas leak detector or soapy water.

## FINISHING

- Wrap the piping joints with the pipe insulation and fasten it with vinyl tape. ( Figure. 18, 19)
- Fill the gap between the inside of wall sleeve and the pipe with a sealer so that rain and wind does not enter. ( Figure. 20 )

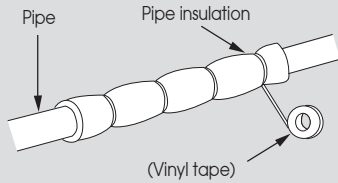

Figure 18

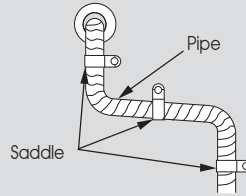

Figure 19

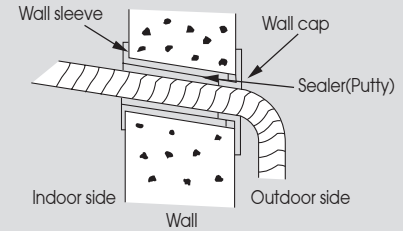

Figure 20



## OUTDOOR UNIT WIRING

- Remove the service cover of the outdoor unit, and connect the end of the connection cord with screws to the terminal block. ( Refer to wiring diagram inside the top cover and caution label on the service cover)
- When connections are completed, fasten the connection cord with the cable clamp and reinstall the service cover. ( Figure. 21 )

### For Cooling Only Model

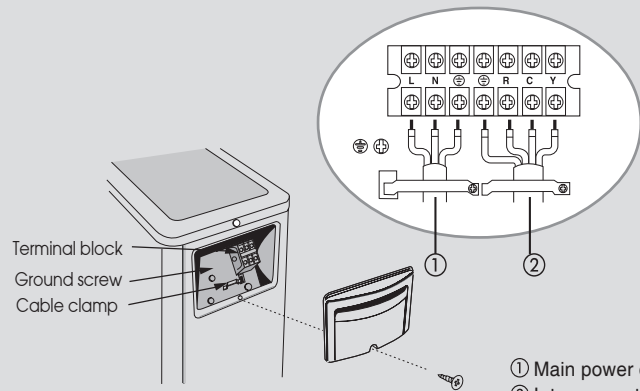

### For Heat Pump Model

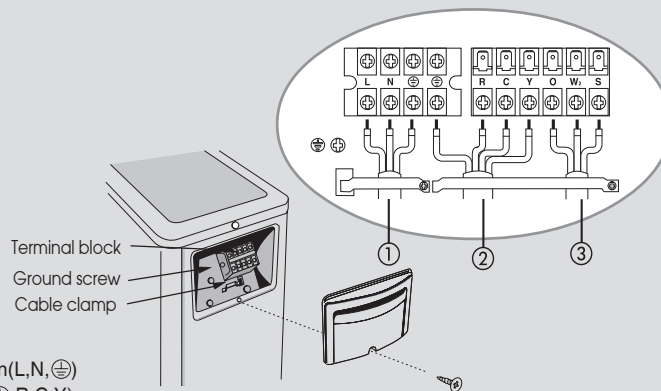

- ① Main power connection(L,N,⊕)
- ② Interconnection wire(⊕,R,C,Y)
- ③ Interconnection wire for Heatpump(O,W2,S)

Figure 21

### NOTE

- The air conditioner always requires grounding.
- Be sure to comply with local codes on running the wire from the indoor unit to the outdoor unit.
- Every wire must be connected firmly.
- During installation, proceed first with refrigerant connections between indoor and outdoor units, and only then make the electrical ones; similarly, when disassembling, disconnect the electrical wiring first and only then open refrigerant connections.
- Unit must be installed according to applicable national installation standards.

## ELECTRICAL CONNECTION

### For Cooling Only Model

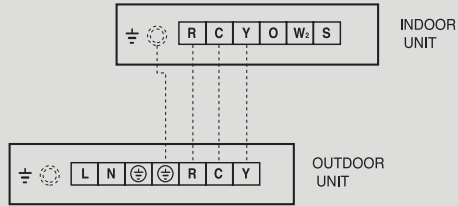

### For Heat Pump Model

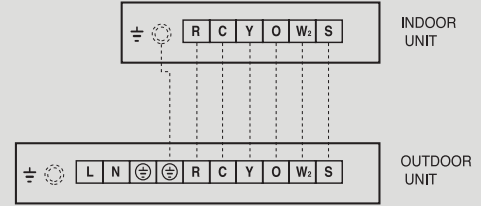

## CONNECTING THE POWER SUPPLY

- The mains supply must be connected to the outdoor unit.

Model	Phase	Starting current	① Main power connection		Interconnection wire size	
			Fuse	Wiresize	② RCY	③ OW <sub>2</sub> S
		A	A	mm <sup>2</sup>	mm <sup>2</sup>	mm <sup>2</sup>
38XPL030C3	60Hz	77	30	4.0	1.0	1.0
38XPL036C3	60Hz	80	40	4.0	1.0	1.0
38XPL030H3	60Hz	77	30	4.0	1.0	1.0
38XPL036H3	60Hz	80	40	4.0	1.0	1.0

## TEST RUNNING

- Perform the operating test after the units have been installed in position and the gas leak test has been completed.
- Check all electrical connections(instructions and wiring diagram).
- Insert the batteries into the remote control and leave it OFF.
- Energise the system, turning the power supply ON.
- Press the **▲** and **☀** buttons of the infrared remote control and hold them pressed for more than 5 seconds. The display will be cleared, the time segments will display the icon(Src=service test)

When test mode is selected, the unit operates as described below:

- The green LED and the orange LED blink every 2 seconds.
- The indoor fan operates at low speed.
- The louver operates according to “Auto heat” or “Auto cool” based on operating mode.
- The system works in Cool Mode at fixed compressor frequency for 3 minutes.
- The system works in Cool Mode until Test Mode is exited.

During the cool mode and heat mode check the following conditions:

1. Difference between indoor ambient temperature and indoor unit air discharge temperature must be greater than 3°C.
2. Indoor fan must operate at low speed.
3. Louver must be in auto heat or cool louver based on operating mode.
4. No fault code must be signalled by the system.

If one of the above conditions is not positive, please check the correct installation of the system.

- After test has been completed. press button **①** on the remote control to leave the test menu.



### NOTE

When 30 minutes have elapsed and no buttons have been pressed, the remote control will automatically exit the test menu and resume its normal operation.

## HIGH PRESSURE CONTROL

Unit for Middle East has high pressure switch to prevent head pressure from being out of limit due to high ambient.

If “High pressure switch” trips, cycle the power supply OFF and ON to reset the system, because electrical box is equipped with relay that prevent the unit from starting, till the indoor unit is switched OFF.

When head pressure drops below 23bar, it is possible to restart the unit switching the indoor control ON.

# CONFIGURATION

## Remote Control Configuration

- Remote Control is used for heat pump type air conditioner and cool only type air conditioner.  
Before user operates air conditioner, thus, cool only type and heat pump type of remote configuration and other items must be selected as follows.

- 1** Press the  $\nabla$  and  $\text{☰}$  buttons of the infrared remote controller and hold them pressed for more than 5 seconds.
- 2** The display will be cleared, the temperature segments will display the first configuration item (CH = remote address) and the time segments will display the default value of this configuration item (Ab = control of both indoor units).
- 3** Press either the  $\nabla$  or  $\nabla$  button to change the default value (A) to the new value (b).
- 4** Press **M** button repeatedly until "tU" is displayed.
- 5** Press either the  $\nabla$  or  $\nabla$  button to change the default value of temperatures in Degrees Celsius (C) to the new value Degrees Fahrenheit (°F).
- 6** Press **M** button repeatedly until "rc" is displayed.
- 7** Press either the  $\nabla$  or  $\nabla$  button to change the default value of Heat pump in model type (HP) to new value cooling only type(co).
- 8** Press **M** button repeatedly until "HR" or "CR" is displayed.
- 9** Press either the  $\nabla$  or  $\nabla$  button to change the default value of Maximum heating setpoint or minimum cooling setpont.
- 10** Press **M** button repeatedly until "CL" is displayed.

**11** Press either the  $\nabla$  or  $\nabla$  button to change the default value of time format as AM/PM (12) to the new value of 24 hours time format (24).

**12** **LOOK OUT! Whichever configuration value changed must be confirmed pressing  $\text{☰}$  button each time.**

**13** Press  $\text{⓪}$  button to leave the configuration menu.

### NOTE

When 30 seconds have elapsed and no buttons have been pressed, the remote controller will automatically exit the configuration menu and the procedure has to be restarted.

Configuration item	Value	Description
"CH"	A : Channel A Ab : Channel A and B b : Channel B	Remote ID selection Defaults to A
"tU"	C : Degrees C F : Degrees F	Temperature units Defaults to C
"rc"	HP : Normal Operation CO : Cooling Only	Puts the Remote into Cooling Only Mode Defaults to HP
"HR"	17-32 : 17°~32°C 63-90 : 63°~90°F	Maximum heating setpoint Degrees C or F is determined by "tU" configuration above
"CR"	17-32 : 17°~32°C 63-90 : 63°~90°F	Minimum cooling setpoint Degrees C or F is determined by "tU" configuration above
"CL"	12 : 12 Hour Standard (AM/PM) 24 : 24 Hour Military	Time Format Defaults to 12

## CONFIGURATION

If you are installing two indoor units in the same room and you want them to operate in independent mode. It is necessary to assign each unit its own address so that each unit can operate via its own remote control. For configuration, proceed as follows.

### Unit configuration

- Press the **M** and **↔** buttons of the infrared remote control and hold them pressed for more than 5 seconds.
- The display will be cleared, the time segments will display the first configuration item (rAdr=remote address) and the temperature segments will display the default value of this configuration item (Ab=control of both indoor units).
- Press either the **∧** or **∨** button to change the default value (Ab) to the new value (A) or (b).
- Press **M** button repeatedly until "ZONE" is displayed.
- Press either the **∧** or **∨** button to change the default value of Zone number (0) to the new value (0-240).
- Press **M** button repeatedly to configure Auto recovery function until "A St" is displayed.
- Press either the **∧** or **∨** button to change the default value of auto restart in last mode (On) to the new value of start in OFF mode (OF).
- LOOK OUT! Whichever configuration value changed must be transmitted to the indoor unit pressing **↔** button each time.
- Press **ⓘ** button to leave the configuration menu.

#### NOTE

When 30 seconds have elapsed and no buttons have been pressed, the remote control will automatically exit the configuration menu and the procedure has to be restarted.

## PUMP DOWN

Pump down means collecting all the refrigerant in the system back into the outdoor unit without losing any refrigerant gas.

Pump down is used when the unit is moved or for servicing the refrigerant circuit.

- Close three-way valve halfway.
- Close two-way valve all the way.
- Turn the unit on for approximately 3 minutes in cooling mode.
- Close three-way valve all the way.

## TROUBLESHOOTING

Trouble	Check Points	Action
Unit does not operate	Check that the power cord is plugged into the wall outlet.	Insert the power cord into the wall outlet.
	Has the circuit breaker tripped or has the fuse blown?	Reset the circuit breaker or replace the fuse with the specified replacement fuse.
	Has there been a power failure?	Restart operation when power is resumed.
	Does the "UNIT ON" lamp flash on and off?	Call your service representative.
	Is the voltage too low?	Confirm the available voltage.
Cooling is abnormally low.	Is the filter blocked with dust?	Clean the air filter.
	Has the temperature been set properly?	Check and reset it if necessary.
	Are the windows or doors open?	Close the windows and doors.
	Is anything obstructing the outdoor unit?	Remove the obstruction.
	Is the fan speed too low?	Change the fan speed selection.
Heating is abnormally low.	Is the filter blocked with dust?	Clean the air filter.
	Has the temperature been set too low?	Check and reset it if necessary.
	Are the windows or doors open?	Close the windows and doors.
	Is anything obstructing the outdoor unit?	Remove the obstruction.
Unit stops during operation.	Is the OFF timer operating?	Restart operation.
	Has the room temperature reached the set temperature?	Normal operation.
If the above actions do not correct the operation, consult the dealer from whom you bought the unit.		

MODEL NO.	INDOOR		42XPL030C3P	42XPL030H3P	42XPL036C3P	42XPL036H3P
	OUTDOOR		38XPL030C3	38XPL030H3	38XPL036C3	38XPL036H3
ELECTRICITY			230V - 60Hz - 1Ph			
CAPACITY	COOL (Btu/h)	(T1)	28500	27000	32500	31500
		(T3)	25000	24000	28500	28000
	HEAT (W)		-	8000	-	9400
INPUT POWER (kW)	COOL	(T1)	2.26	2.26	2.64	2.64
		(T3)	2.70	2.70	3.19	3.19
	HEAT		-	2.15	-	2.66
CURRENT (A)	COOL	(T1)	9.9	9.9	11.7	11.7
		(T3)	11.9	11.9	14.1	14.1
	HEAT		-	9.4	-	11.8
EER (Btu/hW)	COOL	(T1)	12.61	11.95	12.31	11.93
		(T3)	9.26	8.89	8.93	8.78
COP (W/W)	HEAT		-	3.72	-	3.53
REFRIGERANT	(R22)		1.95kg	2.2kg	2.2kg	2.5kg
DIMENSION (MM)	INDOOR		1460*340*277	1460*340*277	1460*340*277	1460*340*277
	OUTDOOR		900*820*320	900*820*320	900*820*320	900*820*320
WEIGHT (KG)	INDOOR		23	23	23	23
	OUTDOOR		51	58	54	61
ANNUAL ENERGY CONSUMPTION (KWH PER YEAR)			6102	6102	7128	7128
COUNTRY OF ORIGIN			MADE IN KOREA			



P/N: 42KHC554040-R



## Free Manuals Download Website

<http://myh66.com>

<http://usermanuals.us>

<http://www.somanuals.com>

<http://www.4manuals.cc>

<http://www.manual-lib.com>

<http://www.404manual.com>

<http://www.luxmanual.com>

<http://aubethermostatmanual.com>

Golf course search by state

<http://golfingnear.com>

Email search by domain

<http://emailbydomain.com>

Auto manuals search

<http://auto.somanuals.com>

TV manuals search

<http://tv.somanuals.com>