

OWNER'S MANUAL

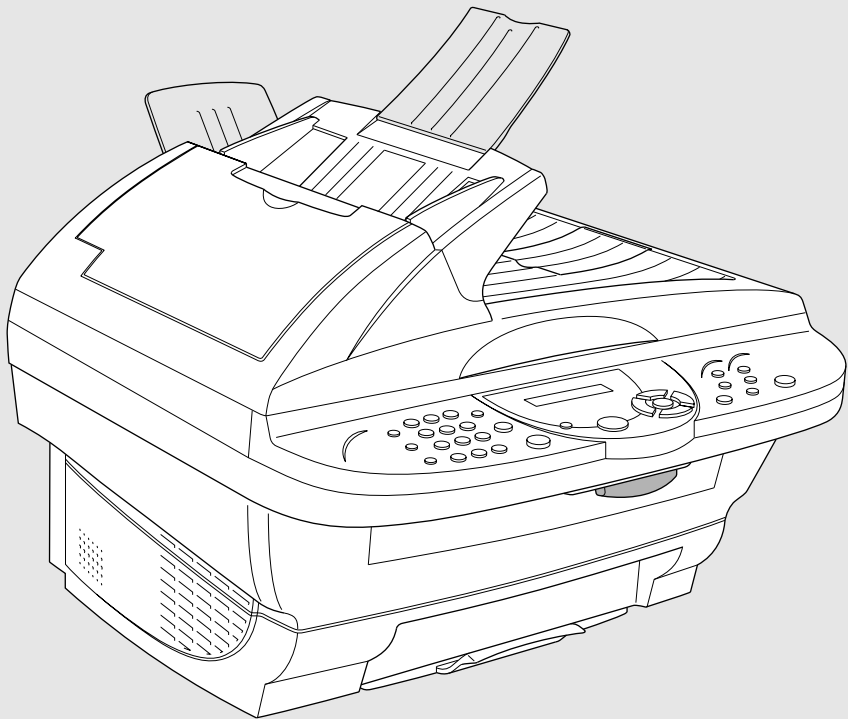

# MFC-6800

---

brother.

version B

## **If You Need to Call Customer Service**

**Please complete the following information for future reference:**

**Model Number: MFC-6800**

**Serial Number\*:** \_\_\_\_\_

**Date of Purchase:** \_\_\_\_\_

**Place of Purchase:** \_\_\_\_\_

**\* The serial number is on the back of the unit. Retain this Owner's Manual with your sales receipt as a permanent record of your purchase, in the event of theft, fire or warranty service.**

# Brother Numbers

---

## IMPORTANT

For technical and operational assistance, you must call the country where you purchased the MFC. Calls must be made *from within* that country.

### Brother fax-back system (USA Only)

Brother Customer Service has installed an easy-to-use fax-back system, so you can get instant answers to common technical questions and product information for all Brother products. This system is available 24 hours a day, 7 days a week. You can use the system to send faxes to any fax machine, not just the one from which you are calling.

If you can't resolve difficulty with your MFC using this manual, call our fax-back system, and follow the voice prompts to receive faxed instructions about using the system, and an index of fax-back subjects.

**In USA:** 1-800-521-2846

The Brother fax-back system number (USA Only) has been preprogrammed on Speed Dial #01.

### Frequently Asked Questions (FAQs)

The Brother Solutions Center is our one-stop resource for all your Fax Machine/Multi-Function Center needs. You can download the latest software and utilities, read FAQs and troubleshooting tips, and go to the "Solutions" section to learn how to get the most from your Brother product.

<http://solutions.brother.com>



You can check here for Brother Printer Driver updates.

### For Customer Service

**In USA:** 1-800-284-4329 (voice)  
1-908-575-8790 (fax)  
1-800-284-3238 (TTY service for the hearing-impaired)

**In Canada:** 1-877-BROTHER (voice)  
1-514-685-4898 (fax)  
1-514-685-6464 (voice) (in Montreal)

### Dealers/Service Centers (USA Only)

For the name of a Brother authorized dealer or service center, call 1-877-BROTHER.

### Service Centers (Canada Only)

For service center addresses in Canada, call 1-877-BROTHER.

# Ordering Accessories and Supplies

## IMPORTANT

For technical and operational assistance, you must call the country where you purchased the MFC. Calls must be made *from within* that country.

For best quality results use only genuine Brother accessories, available at most Brother retailers. If you cannot find the accessory you need and you have a Visa, MasterCard, Discover or American Express credit card, you can order accessories directly from Brother. (In the USA, you can visit us online for a complete selection of Brother accessories and supplies available for purchase.)

**In USA:** 1-888-879-3232 (voice)  
1-800-947-1445 (fax)  
<http://www.brothermall.com>

**In Canada:** 1-877-BROTHER (voice)

Description	Item
Laser Fax Toner	TN-250
Laser Fax Drum	DR-250
Telephone Line Cord	LG3077001
Paper Support	LE1931008
Power Protector for A/C Power and Phone Line Surges and Voltage Spikes	QPD120
Power Protector for A/C Power and Phone Line Surges and Voltage Spikes (8 Outlets)	FX 120
Owner's Manual	LE1984001
IEEE-1284 Bi-directional Parallel Cable	F2A046-10

\*\* Multi-Function Link<sup>®</sup> Pro Suite is NOT available on floppy disks.

## **Notice – Disclaimer of Warranties (For USA and Canada)**

BROTHER'S LICENSOR(S), AND THEIR DIRECTORS, OFFICERS, EMPLOYEES OR AGENTS (COLLECTIVELY BROTHER'S LICENSOR) MAKE NO WARRANTIES, EXPRESS OR IMPLIED, INCLUDING WITHOUT LIMITATION THE IMPLIED WARRANTIES OF MERCHANTABILITY AND FITNESS FOR A PARTICULAR PURPOSE, REGARDING THE SOFTWARE. BROTHER'S LICENSOR(S) DOES NOT WARRANT, GUARANTEE OR MAKE ANY REPRESENTATIONS REGARDING THE USE OR THE RESULTS OF THE USE OF THE SOFTWARE IN TERMS OF ITS CORRECTNESS, ACCURACY, RELIABILITY, CURRENTNESS OR OTHERWISE. THE ENTIRE RISK AS TO THE RESULTS AND PERFORMANCE OF THE SOFTWARE IS ASSUMED BY YOU. THE EXCLUSION OF IMPLIED WARRANTIES IS NOT PERMITTED BY SOME STATES IN THE USA AND SOME PROVINCES IN CANADA. THE ABOVE EXCLUSION MAY NOT APPLY TO YOU.

IN NO EVENT WILL BROTHER'S LICENSOR(S) BE LIABLE TO YOU FOR ANY CONSEQUENTIAL, INCIDENTAL OR INDIRECT DAMAGES (INCLUDING DAMAGES FOR LOSS OF BUSINESS PROFITS, BUSINESS INTERRUPTION, LOSS OF BUSINESS INFORMATION, AND THE LIKE) ARISING OUT OF THE USE OR INABILITY TO USE THE SOFTWARE EVEN IF BROTHER'S LICENSOR HAS BEEN ADVISED OF THE POSSIBILITY OF SUCH DAMAGES. BECAUSE SOME STATES IN THE USA AND SOME PROVINCES IN CANADA DO NOT ALLOW THE EXCLUSION OR LIMITATION OF LIABILITY FOR CONSEQUENTIAL OR INCIDENTAL DAMAGES, THE ABOVE LIMITATIONS MAY NOT APPLY TO YOU. IN ANY EVENT BROTHER'S LICENSOR'S LIABILITY TO YOU FOR ACTUAL DAMAGES FROM ANY CAUSE WHATSOEVER, AND REGARDLESS OF THE FORM OF THE ACTION (WHETHER IN CONTRACT, TORT (INCLUDING NEGLIGENCE), PRODUCT LIABILITY OR OTHERWISE), WILL BE LIMITED TO \$50.

## **Compilation and Publication Notice**

Under the supervision of Brother Industries Ltd., this manual has been compiled and published, covering the latest product descriptions and specifications.

The contents of this manual and the specifications of this product are subject to change without notice.

Brother reserves the right to make changes without notice in the specifications and materials contained herein and shall not be responsible for any damages (including consequential) caused by reliance on the materials presented, including but not limited to typographical and other errors relating to the publication.

## **BROTHER ONE YEAR LIMITED WARRANTY and EXCHANGE SERVICE (For USA Only)**

This warranty gives you certain rights and you may also have other rights that may vary from state to state.

This warranty is given only to the first end-use purchaser of the accompanying product (referred to in this warranty as "this Product").

**What is covered:** Brother warrants to you for the Warranty Period that there are no defects in the materials, workmanship or Year 2000 compliance of this Product. The "Warranty Period" is 1 year from the date you purchased this product. The "Warranty Period" for consumable items, such as Print Heads, Toner, Drums, Ink Cartridges, Print Cartridges, Refill Ribbons, Therma PLUS Paper and Thermal Paper, etc. is 90 days from the date of purchase, or the rated life of the Consumable item, whichever is shorter.

**What is NOT covered:** Warranty WILL BE VOID by Brother for repairs or replacements made necessary due to the following: (1) If the Product was not purchased from an authorized Brother reseller within the United States, (2) The Product has been serviced or modified by anyone other than an Authorized Service Representative of Brother, (3) The serial number has been modified, defaced or removed from this Product, (4) Non-Brother®-brand or non-Brother approved parts, supplies, power supplies or other accessories have been used with this Product, (5) Any damage caused by accident, neglect, abuse or misuse or, the recommended monthly volume has been exceeded, (6) Damages caused as a result of modification, alteration or repairs performed by anyone other than a Brother Authorized Service Representative. (7) NOT COVERED UNDER WARRANTY ARE: Consumable items, for example (including, but not limited to): ribbons, ink or toner cartridges, toner drum units, print heads, cleaning and/or instances where no defects in material or workmanship are found in the Product, etc. (8) Damage caused by improper connection and/or disconnection of the Product; failure of the operator to follow operational instructions, improper set up of the Product.

**What to do if you think your Product is defective:** Call our Customer Service Hotline at 1-800-284-4329, or if you suspect a defect in materials or workmanship in this Product, you can

report it to a Brother Authorized Service Center. During the Warranty Period, supply Brother's representative with a copy of your dated bill of sale showing that this Product was purchased within the United States. For the name of your Brother Authorized Service Center, call 1-800-521-2846. After contacting the Brother Authorized Service Center, you may be required to deliver or send the Product properly packaged, freight prepaid, to the Authorized Service Center together with a photocopy of your bill of sale.

**What Brother will do:** Brother (or its Authorized Service Center) will evaluate your report of a possible defect to determine whether a defect exists, and if it does exist, Brother (or its Authorized Service Center) will repair or (at Brother's option) replace the Product with a product that performs the same functions and performs as well as the original Product. Brother reserves the right to supply refurbished or remanufactured replacement parts provided that the replacement parts conform to the manufacturer's specifications for new products. The repaired or replacement product will be returned to you at no cost.

**Exchange Service:** When an exchange is authorized, Brother will exchange your non-working product with a refurbished or remanufactured product that conforms to the manufacturer's specifications for new products. The refurbished or remanufactured Product you receive will be covered by the balance of the limited warranty period remaining on the original Product, plus an additional thirty (30) days. You will keep the replacement Product that is sent to you and must return (or be billed up to the cost of a new product) your original non-working product, which shall become the property of Brother. You must call Brother Customer Service and if the representative cannot correct the product's malfunction over the telephone and you elect the exchange service, you must provide information pertaining to this Product and you must also provide a valid major credit card number. Your credit card will be charged up to the cost of a new Product if: (i) you do not return your original Product to Brother within five (5) business days; (ii) the malfunctions of your original Product are not covered by the limited warranty;

**BROTHER ONE YEAR LIMITED WARRANTY and EXCHANGE SERVICE  
(For USA Only)**

(iii) the proper packaging instructions are not followed and has caused damage to the product; or (iv) the warranty period on your original Product has expired or has not been sufficiently validated with a copy of the proof of purchase (bill of sale). The Brother Customer Service Representative will ship the exchange Product via next business day delivery courier service, with return instructions and prepaid return air bill. Follow the return instructions. You must return the original Product in the same shipping carton in which the exchanged Product was received and include a copy of proof of purchase (bill of sale). Retain your original accessory items and a copy of the return air bill, signed by the courier.

**Limitations:**

Repair or replacement as described above is your sole and exclusive (that is, your only) remedy if this Product is defective. Brother is not responsible for damage to or loss of any equipment, media, programs or data related to the use of this Product. Except for that repair or replacement, *Brother shall not be liable for any direct, indirect, incidental or consequential damages or specific relief. Because some states do not allow the exclusion or limitation of consequential or incidental damages, the above limitation may not apply to you.*

THIS WARRANTY IS GIVEN IN LIEU OF ALL OTHER WARRANTIES, WRITTEN OR ORAL, WHETHER EXPRESSED BY AFFIRMATION, PROMISE, DESCRIPTION, DRAWING, MODEL OR SAMPLE. ANY AND ALL WARRANTIES OTHER THAN THIS ONE, WHETHER EXPRESS OR IMPLIED, INCLUDING IMPLIED WARRANTIES OF MERCHANTABILITY AND FITNESS FOR A PARTICULAR PURPOSE, ARE HEREBY DISCLAIMED.

This Limited Warranty is the only warranty that Brother is giving for this Product. It is the final expression and the exclusive and only statement of Brother's obligations to you. It replaces

all other agreements and understandings that you may have with Brother or its representatives.

This Limited Warranty (and Brother's obligation to you) may not be changed in any way unless you and Brother sign the same piece of paper in which we (1) refer to this Product and your bill of sale date, (2) describe the change to this warranty and (3) agree to make that change.

**Product Support:**

Toll-free Customer Service and technical support is available for hardware operational assistance at 1-800-284-4329. At any time, free technical support in the form of Frequently Asked Questions, troubleshooting tips and service center locator is available through our fax-back system at 1-800-521-2846 or Brother's Internet Web Site ([www.brother.com](http://www.brother.com)). Now you can visit us on-line ([www.brothermall.com](http://www.brothermall.com)), your complete source for genuine Brother Accessories and Supplies.

**BROTHER INTERNATIONAL CORPORATION  
100 SOMERSET CORPORATE BLVD.  
BRIDGEWATER, NEW JERSEY 08807-0911**

Please record your model and serial numbers and your date and location of Purchase below for your records. Keep this information with your proof of purchase (bill of sale) in case your Product is lost, stolen or requires service.

Model # \_\_\_\_\_

Serial # \_\_\_\_\_

Date of purchase: \_\_\_\_\_

Store where purchased: \_\_\_\_\_

Location of store: \_\_\_\_\_

**Important:**

*We recommend that you keep all original packing materials, in the event that you ship this product.*

**BROTHER MULTIFUNCTION CENTER/FACSIMILE MACHINE  
LIMITED WARRANTY  
(For Canada Only)**

Pursuant to this limited warranty of 1 year from the date of purchase for labour and parts, Brother International Corporation (Canada) Ltd. ("Brother"), or its Authorized Service Centers, will repair this MFC/Facsimile machine free of charge if defective in material or workmanship. This Limited Warranty does not include cleaning, consumables (including, without limitation, print cartridges, print head, toner and drum) or damage caused by accident, neglect, misuse or improper installation or operation, any damage caused from service, maintenance, modifications, or tampering by anyone other than a Brother Authorized Service Representative, or from the use of supplies or consumable items that are non-Brother products. Operation of the MFC/Facsimile machine in excess of the specifications or with the Serial Number or Rating Label removed shall be deemed abuse and all repairs thereafter shall be the sole liability of the end-user/purchaser. In order to obtain warranty service, the MFC/Facsimile machine must be delivered or shipped freight prepaid by the end user/purchaser to a "Brother" Authorized Service Center, together with your Proof of Purchase in the form of a Sales Receipt.

For laser products: Failure to remove the Toner Cartridge (and Toner Drum Unit on applicable models) during shipping will cause severe damage to the MFC/Facsimile and will VOID the Warranty. (Refer to your Operation Manual for proper packaging.)

For ink-jet products: Do not remove the ink cartridges during shipping. Damage to your print head resulting from packing without the ink cartridges will VOID your warranty. (Refer to your Operation Manual for proper packaging.)

BROTHER DISCLAIMS ALL OTHER WARRANTIES EXPRESSED OR IMPLIED INCLUDING, WITHOUT LIMITATION, ANY IMPLIED WARRANTIES OF MERCHANTABILITY OR FITNESS FOR A PARTICULAR PURPOSE, EXCEPT TO THE EXTENT THAT ANY WARRANTIES IMPLIED BY LAW CANNOT BE VALIDLY WAIVED.

No oral or written information, advice or representation provided by Brother, its Authorized Service Centers, Distributors, Dealers, Agents or employees, shall create another warranty or modify this warranty. This warranty states Brother's entire liability and your exclusive remedy against Brother for any failure of the MFC/Facsimile machine to operate properly.

Neither Brother nor anyone else involved in the development, production, or delivery of this MFC/Facsimile machine shall be liable for any indirect, incidental, special, consequential, exemplary, or punitive damages, including lost profits, arising from the use of or inability to use the product, even if advised by the end user/purchaser of the possibility of such damages. Since some Provinces do not allow the above limitation of liability, such limitation may not apply to you.

This Limited Warranty gives you specific legal rights and you may also have other rights which vary from Province to Province.

**Warranty Service is available at Brother Authorized Service Centers throughout Canada. For Technical Support or for the name and location of your nearest Authorized Service Center call 1-877-BROTHER. Within Montreal, please call 685-6464. Internet support: [support@brother.ca](mailto:support@brother.ca) or browse Brother's Web Site: [www.brother.com](http://www.brother.com)**

Brother International Corporation (Canada) Ltd.  
1 Rue Hôtel de Ville  
Dollard-Des-Ormeaux, QC H9B 3H6

We're at your side.  
**brother**®







## Quick Reference Guide

### Sending Faxes

#### Automatic Transmission



- 1 Place the original face up in the ADF, or face down on the scanner glass.
- 2 Enter the fax number using Speed Dial, Search or the dial pad.
- 3 Press **Fax Start**.

#### Sending a Cover Page

- 1 Place the original face up in the ADF, or face down on the scanner glass.
- 2 Press **Menu/Set, 2, 2, 8**.
- 3 When **NEXT FAX ONLY?** appears, press **Menu/Set**.
- 4 Press  to select **ON** (or **OFF**), and then press **Menu/Set**.
- 5 Press  to select a comment, and then press **Menu/Set**.
- 6 Enter two digits to indicate the number of pages being sent, and then press **Menu/Set**.
- 7 Press **1** to select additional settings—**OR**—Press **2** if you are ready to fax.
- 8 Enter the fax number.
- 9 Press **Fax Start**.

### Real Time Transmission

You can send faxes in real time.

- 1 Place the original face up in the ADF, or face down on the scanner glass.
- 2 Press **Menu/Set, 2, 2, 6**.
- 3 Press  to select **ON** (or **OFF**), and then press **Menu/Set—OR—**For the next transmission only, press  to select **NEXT FAX ONLY**, and then press **Menu/Set**.
- 4 For the next fax only, press  to select **ON** (or **OFF**), and then press **Menu/Set**.
- 5 Press **1** to select additional settings—**OR**—Press **2** to fax.
- 6 Enter the fax number.
- 7 Press **Fax Start**.

### Receiving Faxes

#### Select Receive Mode

Press **Receive Mode** to select **FAX ONLY, EXT.TEL/TAD** or **MANUAL**.





## Storing Numbers

### Storing Speed Dial Numbers



- 1 Press **Menu/Set**, **2**, **3**, **1**.
- 2 Enter a two-digit Speed Dial number, and then press **Menu/Set**.
- 3 Enter a number (up to 20 digits), and then press **Menu/Set**.
- 4 Enter a name (or leave it blank), and then press **Menu/Set**.
- 5 Press **Stop/Exit**.

## Dialing Operations

### Speed Dialing

- 1 Place the original face up in the ADF, or face down on the scanner glass.
- 2 Press **Search/Speed Dial**, press **#**, then press the two-digit Speed Dial number.
- 3 Press **Start**.

### Search/Speed Dial





- 1 Place the original face up in the ADF, or face down on the scanner glass.
- 2 Press **Search/Speed Dial**, then enter the first letter of the name you're looking for.
- 3 Press  or  to search the memory.
- 4 Press **Fax Start**. When the LCD shows the name you want to call.

## Making Copies

### Making a Single Copy

- 1 Place the original face up in the ADF, or face down on the scanner glass.
- 2 Press **Copy**.

### Sorting Multiple Copies (Using the ADF)

- 1 Place the original face up in the ADF.
- 2 Use the dial pad to enter the number of copies you want (up to 99).
- 3 Press **Options**.
- 4 Press  **OR**  to select **OPT:STACK/SORT**, and then press **Menu/Set**.
- 5 Press  **OR**  to select **SORT**.
- 6 Press **Copy**.



Brother fax-back system :

In USA: 1-800-521-2846

Brother Global Web Site :

<http://www.brother.com>

Frequently Asked Questions (FAQs)

<http://solutions.brother.com>

Brother Accessories & Supplies:

In USA: 1-888-879-3232 (voice)

1-800-947-1445 (fax)

<http://www.brothermall.com>

In Canada: 1-877-BROTHER (voice)



# Table of Contents

---

## 1

<b>Introduction .....</b>	<b>1-1</b>
Using This Manual .....	1-1
Finding Information.....	1-1
Conventions Used in this Manual.....	1-1
Test Sheet Procedure and Product Registration (For USA Only) .....	1-2
To Complete Your MFC-6800 Registration On-Line: .....	1-2
MFC-6800 Control Panel Overview .....	1-3
About Fax Machines .....	1-5
Custom Features .....	1-5
Do You Have Voice Mail on the Phone Line? .....	1-5
Why Should There Be Trouble? .....	1-5
How Can You Avoid Possible Problems? .....	1-5
Fax Tones and Handshake.....	1-5
ECM (Error Correction Mode).....	1-6

## 2

<b>Assembly and Connections.....</b>	<b>2-1</b>
Packing List.....	2-1
Choosing a Location.....	2-2
Important Safety Instructions .....	2-3
Assembly.....	2-3
Installing the Drum Unit Assembly (with Toner Cartridge) ..	2-3
Setting Up the MFC.....	2-5
Loading Paper.....	2-7
Acceptable Paper .....	2-7
Paper Capacity of Feeder.....	2-8
Connecting an External Telephone .....	2-8
Connecting an External Telephone Answering Device (TAD).....	2-9
Sequence .....	2-9
Connections.....	2-10
Outgoing Message (OGM) on External TAD.....	2-10
Special Line Considerations.....	2-11
Roll Over Phone Lines.....	2-11
Two-Line Phone System.....	2-11
Converting Telephone Wall Outlets .....	2-11
Installing MFC, External Two-Line TAD and Two-Line Telephone .....	2-12

Multi-Line Connections (PBX) .....	2-13
If You are Installing the MFC to Work with a PBX:.....	2-13
Custom Features on a Your Phone Line.....	2-13
Custom Features on a Single Line .....	2-13

### 3

<b>On-Screen Programming.....</b>	<b>3-1</b>
User-Friendly Programming.....	3-1
Menu Selection Table.....	3-1
Navigation Keys .....	3-2

### 4

<b>Initial Setup.....</b>	<b>4-1</b>
Getting Started.....	4-1
Setting Paper Size .....	4-1
Setting Date and Time .....	4-1
Setting Station IDs.....	4-2
Entering Text.....	4-2
Inserting Spaces .....	4-3
Making Corrections.....	4-3
Repeating Letters .....	4-3
Special Characters and Symbols .....	4-3
Setting the Ring Volume .....	4-4
Setting the Beeper Volume.....	4-4
Setting the Speaker Volume .....	4-4
Memory Storage .....	4-4
Turning On Automatic Daylight Savings Time .....	4-5
Toner Save.....	4-5
Sleep Mode.....	4-5
Setting Tone/Pulse Dialing Mode (For Canada Only) .....	4-5

### 5

<b>Setup Receive.....</b>	<b>5-1</b>
Basic Receiving Operations .....	5-1
Choosing the Receive Mode.....	5-1
To Select or Change Your Receive Mode .....	5-2
Setting Ring Delay .....	5-2
Easy Receive .....	5-3
Printing a Reduced Incoming Fax .....	5-3
Setting the Print Density.....	5-4
Advanced Receiving Operations .....	5-4
Operation from Extension Telephone.....	5-4
Changing the Fax Receive Code.....	5-4
Printing a Fax in Memory.....	5-5

Polling.....	5-5
Setting Up Polling Receive.....	5-5
Setting Up Sequential Polling Receive.....	5-6
Canceling a Scheduled Job.....	5-6

## 6

<b>Setup Send .....</b>	<b>6-1</b>
Before You Begin.....	6-1
Sending Faxes Using Multiple Settings .....	6-1
Faxing from the ADF (Automatic Document Feeder) .....	6-1
Setting the Special Media Lever.....	6-2
Faxing from the Scanner Glass.....	6-3
Manual Transmission (With an External Telephone) .....	6-4
Automatic Transmission.....	6-4
Manual and Automatic Fax Redial.....	6-4
Dual Access .....	6-4
Real Time Transmission.....	6-5
Checking Job Status .....	6-6
Canceling a Job While Scanning the Original.....	6-6
Canceling a Job in Memory.....	6-6
Basic Sending Operations .....	6-7
Contrast.....	6-7
Fax Resolution.....	6-7
Composing Electronic Cover Page.....	6-8
Composing Your Own Comments.....	6-8
Cover Page for Next Fax Only.....	6-9
Always Send Cover Page.....	6-9
Using a Printed Cover Page .....	6-10
Advanced Sending Operations .....	6-10
Overseas Mode .....	6-10
Delayed Timer .....	6-11
Delayed FAX.....	6-11
Delayed Batch Transmission .....	6-12
Setting Up Polled Transmit .....	6-12

## 7

<b>Auto Dial Numbers and Dialing Options.....</b>	<b>7-1</b>
Storing Numbers for Easy Dialing .....	7-1
Storing Speed Dial Numbers.....	7-1
Changing Speed Dial Numbers .....	7-1
Setting Up Groups for Broadcasting .....	7-2
Dialing Options .....	7-3

Search .....	7-3
Speed Dialing .....	7-3
Access Codes and Credit Card Numbers.....	7-4
Pause.....	7-4
Fax Redial.....	7-4
Tone/Pulse (For Canada only).....	7-4
Broadcasting .....	7-5

## 8

<b>Telephone Services .....</b>	<b>8-1</b>
Custom Features .....	8-1
Distinctive Ring.....	8-1
What Does Your Telephone Company's	
"Distinctive Ring" Do?.....	8-1
What Does Brother's "Distinctive Ring" Do? .....	8-1
Do You Have Voice Mail?.....	8-2
Before You Choose the Ring Pattern to Register .....	8-2
VERY IMPORTANT .....	8-3
Registering the Distinctive Ring Pattern.....	8-3
Caller ID .....	8-3
Viewing Caller ID List.....	8-4
Printing Caller ID List.....	8-4

## 9

<b>Remote Fax Options.....</b>	<b>9-1</b>
Fax Forwarding/Paging .....	9-1
Programming a Fax Forwarding Number.....	9-1
Programming Paging Number .....	9-1
Setting Fax Storage .....	9-2
Backup Print .....	9-2
Changing Remote Retrieval Access Code.....	9-3
Remote Retrieval .....	9-3
Using Remote Retrieval Access Code.....	9-3
Remote Commands .....	9-4
Retrieving Fax Messages.....	9-5
Changing Fax Forwarding Number.....	9-5

## 10

<b>Printing Reports .....</b>	<b>10-1</b>
MFC Settings and Activity.....	10-1
Customizing the Transmission Verification Report .....	10-1
Setting the Fax Activity Report Interval .....	10-2
Using the Reports Key.....	10-2

To Print a Report.....	10-3
------------------------	------

## 11

<b>Making Copies.....</b>	<b>11-1</b>
Using the MFC as a Copier .....	11-1
Making a Single Copy (Using the ADF).....	11-1
Making Multiple Copies (Using the ADF).....	11-1
Single or Multiple Copies (Using the Scanner Glass).....	11-2
Out of Memory Message .....	11-2
Temporary Copy Settings.....	11-3
Copying Using Multiple Settings .....	11-3
Using Enlarge/Reduce Key .....	11-4
Copy Contrast.....	11-5
Using the Options Key .....	11-5
Copy Mode (Type of Original).....	11-5
Sorting Multiple Copies (Using the ADF) .....	11-6
Special Copy Options (Using the ADF).....	11-6
Special Copy Options (Using the Scanner Glass) .....	11-6
2 in 1 .....	11-7
4 in 1 .....	11-7
Poster.....	11-7
Paper Type.....	11-7
Changing Default Copy Settings.....	11-8
Copy Mode (Type of Original).....	11-9
Copy Contrast.....	11-9
Paper Type.....	11-9

## 12

<b>Using Brother Machine as a Printer .....</b>	<b>12-1</b>
Special Printing Features.....	12-1
Windows® Printing.....	12-1
Bi-directional Parallel Interface .....	12-1
Printing from Your PC .....	12-1
Multi-purpose Sheet Feeder .....	12-1
Two-Sided Printing (Manual Duplex).....	12-2
Loading Envelopes in Multi-purpose Sheet Feeder .....	12-2
Paper Tray .....	12-3
Simultaneous Printing/Faxing .....	12-3
Choosing Acceptable Paper .....	12-4
Printer Operations .....	12-4
Reset Key.....	12-4

<b>Printer Driver Settings (For Windows® Only)</b> .....	<b>13-1</b>
Using the Brother MFC-6800 Printer Driver .....	13-1
Features in the PCL Printer Driver	
(For Windows® Users Only) .....	13-1
Basic Tab .....	13-2
Paper Size .....	13-3
Multiple Page .....	13-3
Border Line .....	13-3
Orientation .....	13-3
Copies .....	13-3
Collate .....	13-4
Media Type .....	13-4
Advanced Tab .....	13-5
Print Quality (*1) .....	13-5
Resolution .....	13-5
Toner Save .....	13-5
Print Setting	
(For Windows® 95/98/98SE/Me Users Only) .....	13-6
Duplex Printing (*2) .....	13-6
Manual Duplex .....	13-6
Binding Offset .....	13-6
Watermark (*3) .....	13-7
Print Watermark .....	13-7
In background .....	13-7
Watermark Text .....	13-8
Watermark Bitmap .....	13-8
Position .....	13-8
Page Setting (*4) .....	13-9
Device Options (*5) .....	13-10
Quick Print Setup .....	13-11
Administrator	
(For Windows® 95/98/98SE/Me Users Only) .....	13-11
Print Date & Time .....	13-12
Support .....	13-13
Brother Solutions Center .....	13-13
Web Update .....	13-13
Check Setting .....	13-13
Features in the Printer Driver (For Windows® 2000) .....	13-14
General Tab .....	13-14
Printing Preferences .....	13-14
Layout Tab .....	13-15



*1 Orientation .....	13-15
*2 Pages Per Sheet .....	13-16
Paper/Quality Tab.....	13-16
*1 Paper Source .....	13-16
*2 Media .....	13-17
Advanced Options.....	13-17
*1 Paper /Output .....	13-17
*2 Graphic.....	13-18
*3 Document Options .....	13-18
Device Settings Tab (Not Available) .....	13-19

**Using the Windows®-Based Brother MFL-Pro Control Center**

<b>(For Windows® Only) .....</b>	<b>14-1</b>
Brother MFL Pro Control Center .....	14-1
AutoLoad the Brother Control Center .....	14-1
How to Turn Off AutoLoad.....	14-2
Using the Scan Key .....	14-2
Using the Control Panel Keys .....	14-2
Scan Image .....	14-3
Scan/OCR.....	14-3
Scan to E-mail .....	14-3
Brother Control Center Features .....	14-4
Auto Configuration.....	14-4
Scanning Operations.....	14-4
Copy Operations .....	14-5
PC Fax Operation .....	14-5
Scanner Settings for Scan, Copy and PC Fax Buttons .....	14-5
Global Settings .....	14-5
Setting Up the Scanner Configurations .....	14-6
To Access the Scanner Configurations Screen.....	14-6
Perform an Operation from the Control Center Screen.....	14-7
Scan to File.....	14-7
Scanner Settings .....	14-7
Destination Folder .....	14-8
Scan to E-mail .....	14-8
Scanner Settings .....	14-9
E-mail Application .....	14-9
File Attachments.....	14-9
Conversion Options .....	14-10
Format .....	14-10
Show QuickSend Menu .....	14-10

QuickSend List.....	14-10
Scan to Word Processor .....	14-11
Scanner Settings .....	14-11
Word Processor .....	14-12
User-Defined Button .....	14-13
Scanner Settings .....	14-13
Target Application.....	14-13
Copy .....	14-14
Scanner Settings .....	14-14
Copy Settings.....	14-14
Send a Fax .....	14-15
Scanner Settings .....	14-15
FAX Settings .....	14-16

## 15

<b>Scanner and Using ScanSoft™ PaperPort® and TextBridge® OCR.....</b>	<b>15-1</b>
Using ScanSoft™ PaperPort® and TextBridge® .....	15-1
Viewing Items .....	15-2
Organizing Your Items in Folders.....	15-2
Links to Many Other Applications .....	15-3
Using ScanSoft™ TextBridge® OCR (Converting Image Text to Text You Can Edit) .....	15-3
Importing Items from Other Applications.....	15-3
Exporting Items in Other Formats.....	15-4
Exporting an Image File.....	15-4
Accessing the Scanner.....	15-4
Scanning an Image into Your PC .....	15-5
Settings in the Scanner Window.....	15-5
Image.....	15-5
Contrast.....	15-6
Custom .....	15-6
PreScanning an Image .....	15-7

## 16

<b>Setting Up and Using PC FAX (For Windows® Only) .....</b>	<b>16-1</b>
Introduction .....	16-1
Brother Resource Manager.....	16-1
MFC Remote Setup.....	16-2
PC FAX Sending (For Windows® Only) .....	16-3
Setting Up User Information .....	16-3
Setting Up Sending.....	16-4

Outside line access .....	16-4
Include header .....	16-4
Address Book file .....	16-4
User interface.....	16-5
Simple Style .....	16-5
Facsimile Style.....	16-5
Setting Up Speed Dial .....	16-6
The Address Book .....	16-7
Setting Up a Member in the Address Book.....	16-8
Setting Up a Group for Broadcasting .....	16-9
Editing Member Information.....	16-9
Deleting a Member or Group .....	16-10
Exporting the Address Book .....	16-10
Importing to the Address Book .....	16-11
Setting Up a Cover Page.....	16-12
To .....	16-13
From.....	16-13
Comment.....	16-13
Select Cover Page Form.....	16-13
Import BMP file .....	16-13
Count Cover Page .....	16-13
Sending a File as a PC-FAX Using the Facsimile Style ...	16-14
Redial .....	16-15
Sending a File as a PC-FAX Using the Simple Style.....	16-15

## 17

<b>Using Automatic E-Mail Printing.....</b>	<b>17-1</b>
For Windows® 95, 98, 98SE, Me Only .....	17-1
Main Features .....	17-1
To Access the On-Line Documentation.....	17-1
To Install Automatic E-mail Printing (Optional Application) .....	17-1

## 18

<b>Using the Brother MFC with a New Power Macintosh® G3, G4 or iMac™/iBook.....</b>	<b>18-1</b>
Set up Your USB Equipped Apple® Macintosh® G3,G4, iMac™ or iBook with Mac OS 8.5/8.51/8.6/9.0/9.0.4/9.1 .....	18-1
Using Brother Printer Driver with Your Apple® Macintosh® ..	18-1
Sending a Fax from Your Macintosh® Application .....	18-3
Setting Up Your Address Book.....	18-5
Adding a New Member.....	18-5

Adding a New Group .....	18-6
Using Brother TWAIN Scanner Driver with Your Apple® Macintosh® .....	18-7
Accessing the Scanner .....	18-8
Scanning an Image into Your Macintosh G3, G4 or iMac .....	18-8
Settings in the Scanner Window .....	18-9
Image .....	18-9
Scanning Area .....	18-10
Business Card Size .....	18-10
Adjust Image .....	18-11
PreScanning an Image .....	18-12

## 19

<b>Important Information .....</b>	<b>19-1</b>
Standard Telephone and FCC Notices .....	19-1
Laser Safety .....	19-2
FDA Regulations .....	19-2
Federal Communications Commission (FCC)	
Declaration of Conformity (For USA Only) .....	19-3
Important .....	19-3
Industry Canada Compliance Statement .....	19-4
Important—About the Interface Cable .....	19-4
Warranty .....	19-4
International ENERGY STAR®	
Compliance Statement .....	19-4
Important Safety Instructions .....	19-5
Trademarks .....	19-7

## 20

<b>Troubleshooting and Routine Maintenance .....</b>	<b>20-1</b>
Troubleshooting .....	20-1
Error Messages .....	20-1
Document Jams and Paper Jams .....	20-5
Original is Jammed in the Top of the ADF Unit .....	20-5
Original is Jammed Inside the ADF Unit .....	20-5
Printer Jam .....	20-6
Paper is Jammed in the Multi-purpose Sheet Feeder ...	20-6
Paper is Jammed near the Drum Unit .....	20-7
If You Are Having Difficulty with Your MFC .....	20-8
Packing and Shipping the MFC .....	20-15
Routine Maintenance .....	20-17
Cleaning the Scanner .....	20-17
Cleaning the Printer .....	20-18

Cleaning the Drum Unit .....	20-19
Replacing the Toner Cartridge .....	20-19
Toner Empty Indicator .....	20-20
Replacing the Drum Unit.....	20-24
<b>Glossary.....</b>	<b>G-1</b>
<b>Specifications .....</b>	<b>S-1</b>
Product Description .....	S-1
Fax .....	S-1
Printer .....	S-2
Computer Requirements .....	S-3
Electrical and Environment .....	S-3
Parallel Interface.....	S-4
USB (Universal Serial Bus) Interface .....	S-4
<b>Index.....</b>	<b>I-1</b>
<b>Remote Retrieval Access Card.....</b>	<b>R-1</b>



# 1 Introduction

## Using This Manual

---

Thank you for purchasing a Brother multi-function center (MFC). This MFC has been designed to be simple to use, with LCD screen prompts to guide you through programming your MFC. However, you can use your MFC to its fullest potential by taking a few minutes to read this manual.



Additionally, your MFC has a **Reports** key. Press **Reports** and **1** to print a list of basic step instructions and explanations.

## Finding Information

All chapter headings and subheadings are listed in the Table of Contents. You will be able to find information about a specific feature or operation by checking the Index in the back of this manual.

## Conventions Used in this Manual

Throughout this manual you'll see special symbols alerting you to important information, warnings, and actions to perform. For clarification, and to help you choose the correct key presses, we've added illustrations of some LCD messages.

<b>boldface</b>	Bold typeface identifies a specific key on the MFC control panel.
<i>italics</i>	Italics typeface emphasize an important point, or refer you to related topic.
bubble dot	Bubble Dot typeface identifies the messages on the LCD of the MFC.



Warnings detail precautions you must take to avoid possible personal injury.



Cautions specify procedures you must follow or avoid to prevent possible damage to the MFC.



Notes tell you the proper response for a situation that may occur.



FYI tips provide details about how the current operation interacts with other features.



Improper Setup alerts you to devices and procedures that are not compatible with the MFC.

## **Test Sheet Procedure and Product Registration (For USA Only)**

---

After programming your Station ID, please fill out the TEST SHEET included with your MFC, and then fax it to Brother's Automated Fax Response System as your first transmission. This will verify that your MFC is properly installed. To get a response, you must have set up your Station ID. (See *Setting Station IDs*, page 4-2.)

**In USA:** 1-877-268-9575 (fax)

When your TEST SHEET is received, a Confirmation Sheet and Product Registration form will be sent back to your MFC. Please fill out the form and return it to complete your registration.

### **To Complete Your MFC-6800 Registration On-Line:**

- 1** Insert the MFL Pro Suite CD-ROM into your CD-ROM drive.
- 2** Click **On-Line Registration** to register your product from the main menu.



# MFC-6800 Control Panel Overview

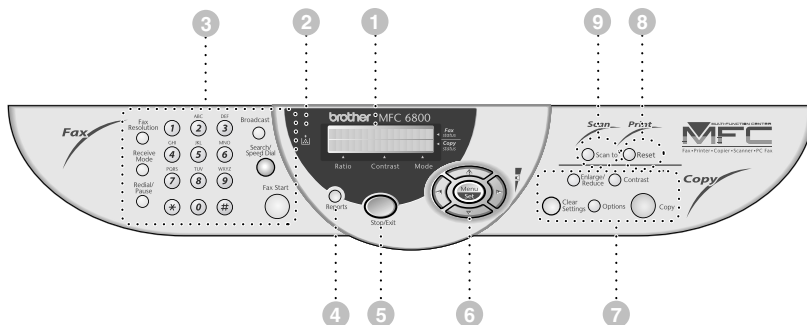

## 1 Liquid Crystal Display (LCD)

The LCD displays messages to help you set up and operate your MFC.

## 2 Toner Empty Indicator

Blinks when the toner cartridge is low and stays lit when toner is empty.

## 3 Fax Keys:

### Fax Resolution

Sets the resolution when you send a fax.

### Receive Mode

Use to select how the MFC will handle incoming calls.

### Redial/Pause

Redials the last number called. Also inserts a pause in auto dial numbers.

### Dial Pad

Use to dial phone and fax numbers and as a keyboard for entering information into the MFC.

(For Canada Only): The # key lets you switch the dialing type during a telephone call from **PULSE** to **TONE**.

### Broadcast

Use this key when you want to broadcast the same fax to many different locations (maximum of 150 locations at once).

## Search/Speed Dial

Lets you look up numbers stored in the dialing memory. Also lets you dial stored phone numbers by pressing # and a two-digit number.

## Fax Start

Starts an operation, such as sending a fax.

## 4 Reports

Accesses the Reports menu so you can select a report to print: Help List, Auto Dial, Fax Activity, Transmission Verification and User Settings.

## 5 Stop/Exit

Stops a fax, cancels an operation, or exits from Menu mode.

## 6 Navigation Keys:

### Menu/Set

Lets you access the Menu and Programming mode and stores your settings in the MFC.



Press to scroll forward or backward to set a menu selection.

Also, you can use these keys to do an alphabetical search for the names of stored numbers.



### Volume

Press to scroll through the menus and options.

While the MFC is ringing or you are listening through the speaker, you can press these keys to adjust the volume.

## 7 Copy Keys (Temporary Settings):

### Enlarge/Reduce

Lets you enlarge or reduce copies depending upon the ratio you select.

### Contrast

Lets you make a copy that is lighter or darker than the original.

### Options

You can quickly and easily select temporary settings.

### Clear Settings

Resets your temporary copy settings back to the factory default settings. Use this key when you do not want to wait 45 seconds for the temporary settings to clear automatically.

### Copy

Makes copy.

## 8 Print Key:

### Reset

Clears data from the printer memory.

## 9 Scan Key:

### Scan to

Lets you scan the next original into your computer and select the type of destination: word processing, graphics or E-mail application.

# About Fax Machines

---

If you're a first-time fax machine user, fax operation might seem a little mysterious. Soon, you'll recognize the unusual fax tones on your phone line, and be able to send and receive faxes easily.

## Custom Features

### Do You Have Voice Mail on the Phone Line?

If you have Voice Mail on the phone line on which you will install your new MFC, *there is a strong possibility that Voice Mail and the MFC will conflict with each other while receiving incoming calls.*

### Why Should There Be Trouble?

Since both the MFC and Voice Mail will pick up the line at the number of rings you have set, each of them has the ability to keep the other from receiving calls. For example, if your Voice Mail is set to answer after two rings and your MFC is set to answer after four, your Voice Mail will keep your MFC from receiving faxes. If you set Voice Mail and the Brother MFC to answer at the same number of rings, there is no way of knowing which one will answer first. It is important to remember that neither Voice Mail nor the MFC can pass the call back to the other after the call has been answered.

### How Can You Avoid Possible Problems?

A very good way to avoid problems like the one mentioned previously is *to get a second phone number on your present phone line.* Many people with Voice Mail opt for this choice, which is called "Distinctive Ring", and they are very satisfied with it. *For details about this type of custom service, please see Distinctive Ring, page 8-1.*

Another way to avoid possible problem is to replace your Voice Mail with an answering machine. Your Brother MFC is designed to work in tandem with an answering machine or TAD (telephone answering device). (*See Connecting an External Telephone Answering Device (TAD), page 2-9.*)

## Fax Tones and Handshake

When someone is sending a fax, the MFC sends fax calling tones (CNG tones) — soft, intermittent beeps at 4-second intervals. You'll hear them after you dial and press **Fax Start**; they continue for about 60 seconds after dialing. During that time, the sending machine must begin the "handshake" with the receiving machine. Each time you use automatic procedures to send a fax, you are sending CNG tones over the phone line. You'll soon learn to listen for these soft beeps each time you answer a phone on your fax line, so you can know if you are receiving a fax message.

The receiving fax responds with fax receiving tones—loud, chirping sounds. A receiving fax chirps for about 60 seconds over the phone line, and the LCD shows **RECEIVING**. If your MFC is set to the FAX mode, it will answer every call automatically with fax receiving tones. Even if the other party hangs up, your MFC continues to send the “chirps” for about 60 seconds, and the LCD continues to show **RECEIVING**. To cancel the receiving mode, press **Stop/Exit**.

The fax “handshake” is the time in which the sending machine’s CNG tones and the receiving machines “chirps” overlap. This must be for at least 2 to 4 seconds, so the machines can understand how each is sending and receiving the fax. The handshake cannot begin until the call is answered, and the CNG tones only last for about 60 seconds after the number is dialed. Therefore, it’s important for the receiving machine to answer the call in as few rings as possible.



When you have an external telephone answering device (TAD) on your fax line, your TAD will determine the number of rings before the call is answered. Pay special attention to the directions chapter for connecting a TAD to your MFC in Chapter 2, *Assembly and Connections*.

## **ECM (Error Correction Mode)**

The Error Correction Mode (ECM) is a way for the MFC to check the integrity of a fax transmission while it is in progress. ECM transmissions are possible only between machines that both have the ECM feature. If they do, you may send and receive fax messages that are continuously checked for their integrity.

Sufficient memory must be available in your MFC for this feature to work.

# 2

# Assembly and Connections

## Packing List

Make sure you have the following items:

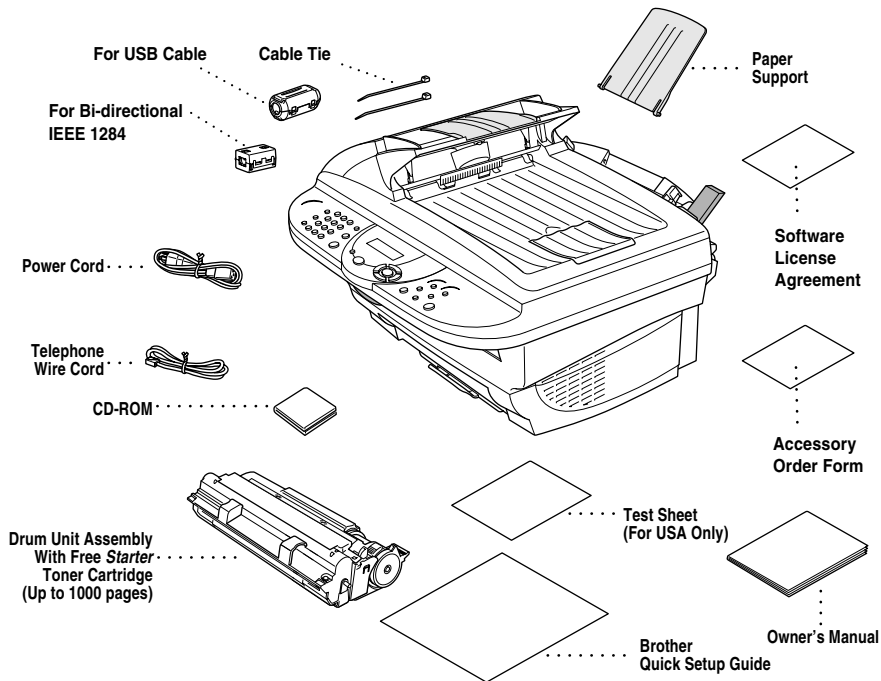

### ! Caution

Do NOT throw away the filter cores and cable ties by accident. You will need them to meet FCC Emission Requirements when you connect the MFC to your computer using a USB cable or a bi-directional IEEE-1284 compliant parallel cable.



If an item is missing, call Brother Customer Service at 1-877-BROTHER (in USA), 1-877-BROTHER (in Canada) or 1-514-685-6464 (in Montreal). See *Ordering Accessories and Supplies* on page ii for the correct item numbers.



Whenever you transport the MFC, use the packing materials that came with MFC. If you do not pack the MFC properly, you may void your warranty.

## Choosing a Location

Place your MFC on a flat stable surface, such as a desk. Select a place that is free of vibration and shocks. Place the MFC near a telephone jack and a standard, grounded power outlet. Choose a location where the temperature remains between 50°F and 90.5°F (10°–32.5°C).

- ⊘ Avoid placing your MFC in a high-traffic area. Do not place near heaters, air conditioners, water, chemicals, or refrigerators. Do not expose the MFC to direct sunlight, excessive heat, moisture, or dust. Do not connect your MFC to electrical outlets controlled by wall switches or automatic timers. Disruption of power can wipe out information in the MFC's memory. Do not connect your MFC to electrical outlets on the same circuit as large appliances or other equipment that might disrupt the power supply. Avoid interference sources, such as speakers or the base units of cordless phones.

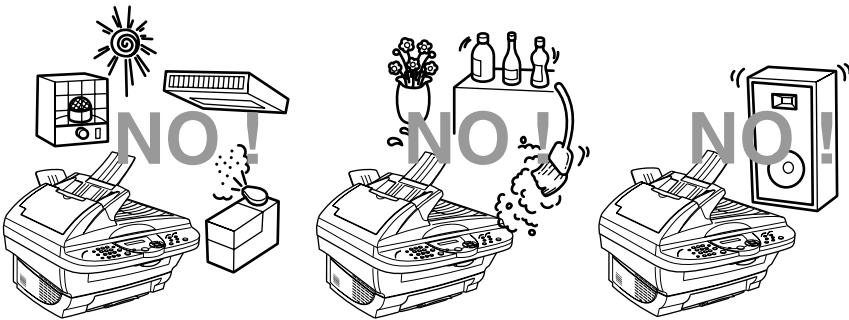

### **⚠ WARNING**

- Use caution when installing or modifying telephone lines. Never touch telephone wires or terminals that are not insulated unless the telephone line has been disconnected at the wall jack. Never install telephone wiring during a lightning storm. Never install a telephone jack in a wet location unless the jack is specifically designed for a wet location.
- Lightning and power surges can damage this product! We recommend that you use a quality surge protection device on the AC power line and on the telephone line, or unplug the lines during a lightning storm.
- For PLUGGABLE EQUIPMENT, the socket-outlet should be installed near the equipment and should be easily accessible.
- To reduce the risk of shock or fire, use only a No. 26 AWG or larger telecommunication line cord.

## Important Safety Instructions

When using your telephone equipment, basic safety precautions should always be followed to reduce the risk of fire, electric shock and injury to persons, including the following:

- 1 Do not use this product near appliances that use water, in a wet basement or near a swimming pool.
- 2 Avoid using a telephone during an electrical storm. There may be a remote risk of electric shock from lightning.

## Assembly

---

### Installing the Drum Unit Assembly (with Toner Cartridge)

- 1 Unpack the drum unit assembly, including the toner cartridge, and gently rock it from side to side five or six times to distribute the toner evenly inside the cartridge.

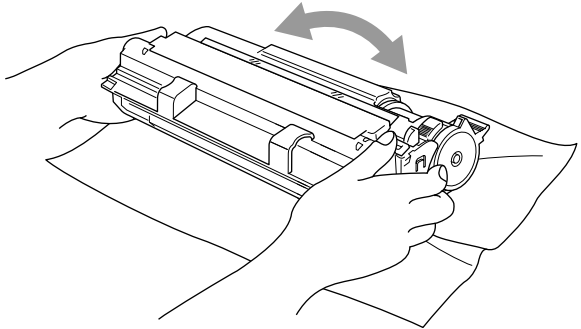

To prevent damage to the drum, do NOT expose it to light for longer than a few minutes.

Do NOT remove the starter sheet—this will be ejected while the MFC is warming up.

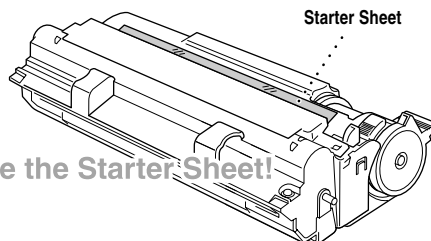

Do NOT remove the Starter Sheet!

**2** Open the top cover of the MFC by pulling the lever toward you and lifting the cover.

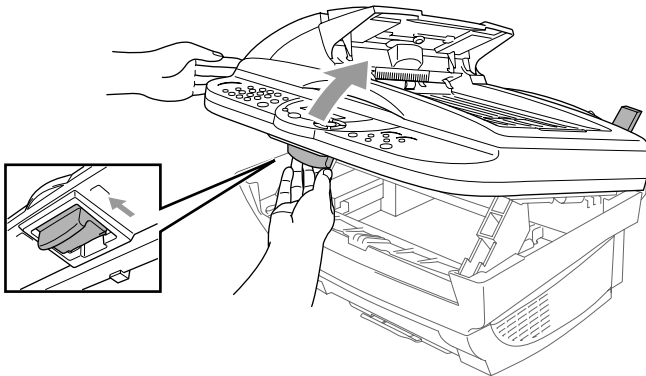

**3** Holding the drum unit by its handles, insert it into the MFC.

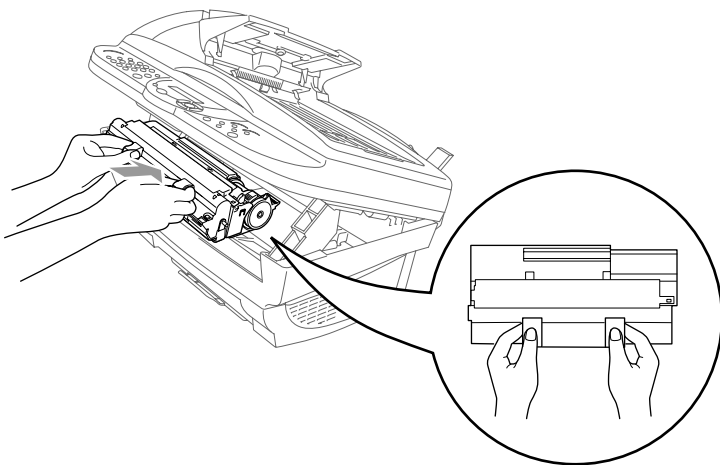

**4** Close the top cover.

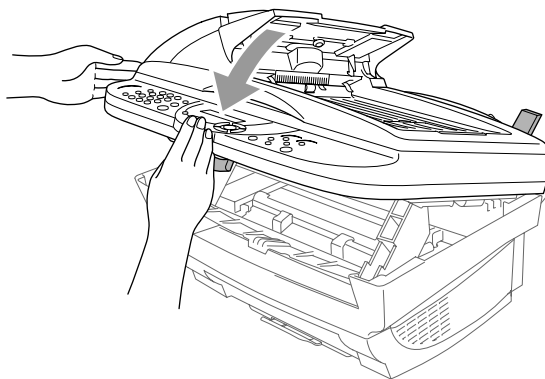



## Setting Up the MFC

Follow the instructions below to connect the power cord, and telephone line.

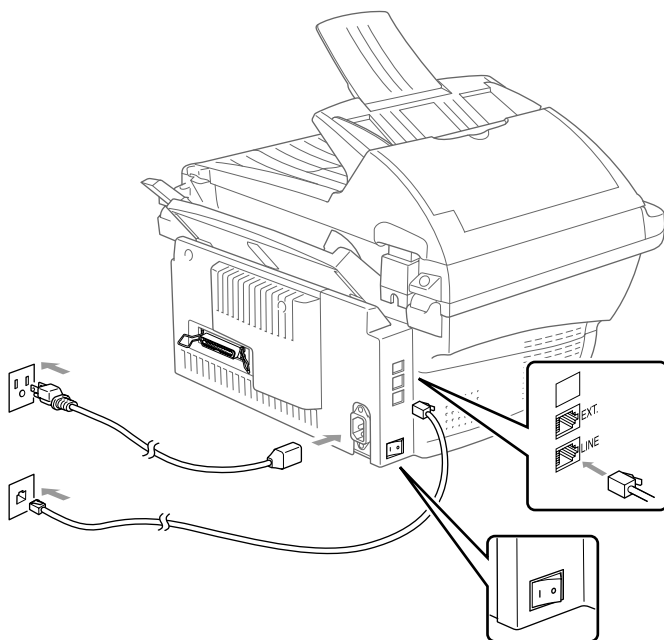

- 1 Connect the power cord.
- 2 Turn the MFC power switch ON.

### **WARNING**

- This MFC must be grounded using a three-prong plug.
- Since the MFC is grounded through the power outlet, you can protect yourself from potentially hazardous electrical conditions on the telephone network by keeping the power to your MFC on when you connect it to a telephone line. Similarly, you can protect yourself when you want to move your MFC, by disconnecting the telephone line first, and then the power cord.
- Lightning and power surges can damage this product! We recommend that you use a quality surge protection device on the AC power line as well as on the telephone line, or unplug the lines during a lightning storm.
- Do not touch the rollers at the paper exit.

- 3 Connect the telephone line.

Connect one end of the telephone line cord to the jack labeled **LINE** on the left side of the MFC. Connect the other end to a modular wall jack.

**4** Attach the plastic paper support to the MFC.

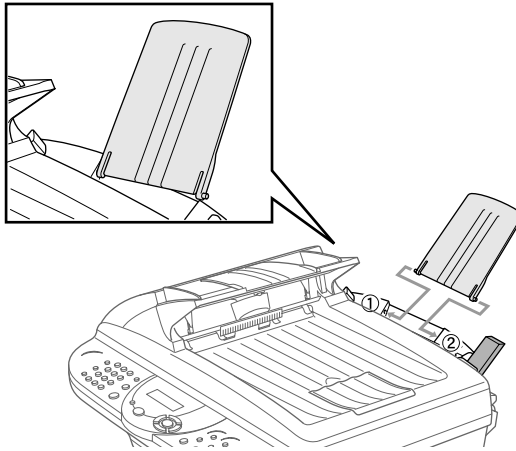

**5** Pull out the paper tray and the extension.

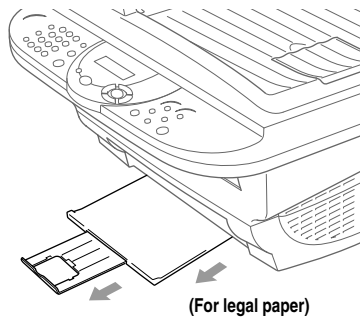

**6** If your paper size is A4 or Letter, unfold the paper stopper by pulling it toward you.

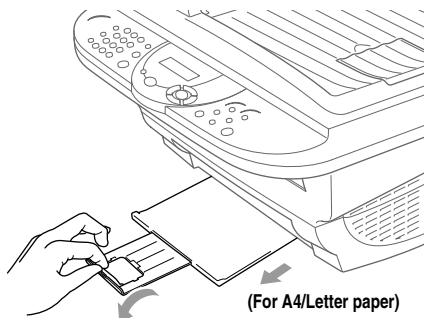

## Loading Paper

- 1 Adjust the guides to fit the paper (to help prevent paper jams).

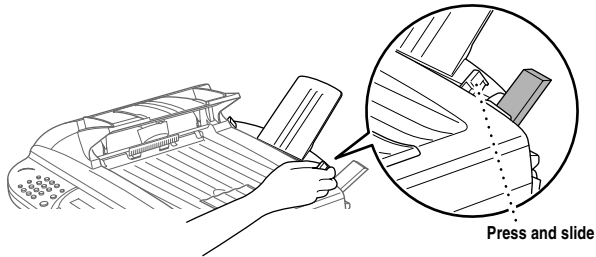

- 2 Fan the paper well. Push down the paper lever. Load the paper with the lever down. Make sure the print side is toward the fax machine and the paper level is stacked below the paper mark. The feeder can hold up to 200 sheets of paper or up to 10 envelopes.

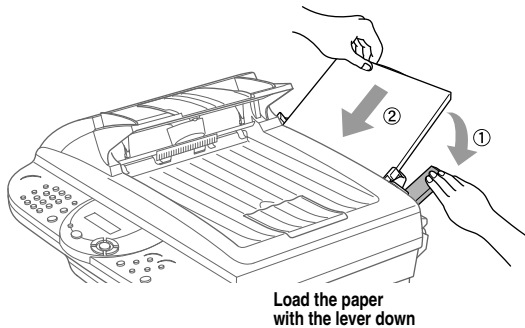

## Acceptable Paper

The MFC can handle paper that has the following specifications.

But please note that you can receive *fax messages* only on Letter, Legal and A4 paper. If you use legal or A4, change the Paper Size setting: (**Menu/Set, 1, 1.**)

Paper Type	Paper Size
Cut sheet	Letter, A4, Legal, B5, A5, Executive, Custom size 2.75-8.5 × 5-14 inches (70-216 × 127-356 mm)
Envelopes	DL, C5, COM-10, Monarch
Post Card	2.75-8.5 × 5-11 inches (70-216 × 127-279 mm)
Organizer	Day-Timer® J, K, L, M 2.75-8.5 × 5-11 inches (70-216 × 127-279 mm)
Labels and Transparencies	2.75-8.5 × 5-14 inches (70-216 × 127-356 mm)

## Paper Capacity of Feeder

Multi-purpose Sheet Feeder:

Up to 0.87 inch (22 mm) in height (up to the mark) Approx. 200 sheets of 20 lb. (75 g/m<sup>2</sup>) or 50 sheets of 42 lb. (158 g/m<sup>2</sup>) Letter/A4 paper, or 10 envelopes

Output Tray:

Approx. 50 sheets of 20 lb. (75 g/m<sup>2</sup>) Letter/A4 paper

	Cut Sheet	Envelopes
Basis Weight	17 to 42 lb. (64 to 158 g/m <sup>2</sup> )	20 to 24 lb. (75 to 90 g/m <sup>2</sup> ) single thickness
Caliper	±0.003 to ±0.008 in. (0.08 to 0.2 mm)	0.0033 to 0.0058 in. (0.084 to 0.14 mm) single thickness
Moisture Content	4% to 6% by weight	4% to 6% by weight
Smoothness	100 to 250 (Sheffield)	100 to 250 (Sheffield)



Recommended Paper Types:

Cut sheet: Xerox 4200

Label: Avery *laser* label or equivalent

Transparency: 3M CG3300 for *laser* printers or equivalent

## Connecting an External Telephone

Although your MFC does not have a handset, you can connect a separate telephone (or telephone answering device) directly to your MFC.

Connect the modular plug on the telephone's line cord to the jack labeled EXT. on the left side of the MFC.

Whenever this phone (or TAD) is in use, the LCD shows **TELEPHONE**.

## Connecting an External Telephone Answering Device (TAD)

### Sequence

You may choose to connect an answering system. However, when you have an **external** TAD on the same telephone line as the MFC, the TAD answers all calls. The MFC “listens” for fax calling (CNG) tones. If it hears them, the MFC takes over the call and receives the fax. If it doesn’t hear CNG tones, the MFC lets the TAD continue playing your outgoing message so your caller can leave you a voice message.

The TAD must answer within five rings (the recommended setting is two rings). The MFC cannot hear CNG tones until the TAD has answered the call, and with five rings there are only 8–10 seconds of CNG tones left for the fax “handshake.” Make sure you carefully follow instructions in this manual for recording your outgoing message. We do not recommend using the toll saver feature on your external answering machine if it exceeds five rings.



If you do not receive all your faxes, you must reset the setting on your external TAD to 4 rings.



*If You Subscribe to Your Telephone Company’s Distinctive Ring Service:*

You may connect an external TAD to a separate wall jack *only* if you subscribe to your telephone company’s Distinctive Ring service, have registered the distinctive ring pattern on your machine, use that number as a fax number and set your machine’s Receive mode to **MANUAL**. The recommended setting is three or four rings on the external TAD when you have the telephone company’s Distinctive Ring service.



*If You Do Not Subscribe to Distinctive Ring Service:*

You *must* plug your TAD into the EXT. jack of your MFC. If your TAD is plugged into a wall jack, both your machine and the TAD will try to control the phone line. (See illustration on page 2-10.)

- ⊘ **Do not connect a TAD elsewhere on the same phone line** (unless you have the Distinctive Ring service).

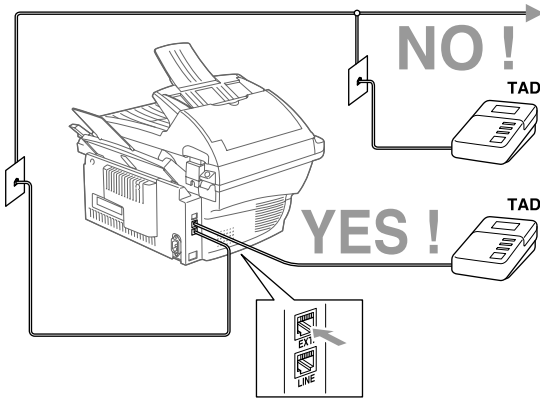

## Connections

The external TAD **must** be plugged into the left side of the MFC, into the jack labeled EXT. Your MFC cannot work properly if you plug the TAD into a wall jack (unless you are using Distinctive Ring).

- 1 Plug the telephone line cord from the wall jack into the left side of the MFC, in the jack labeled LINE.
- 2 Plug the telephone line cord from your external TAD into the left side of the MFC, in the jack labeled EXT. (Make sure this cord is connected to the TAD at the TAD's telephone line jack, and not its telephone set jack.)
- 3 Set your external TAD to four rings or less. Two rings are recommended. (The MFC's Ring Delay setting does not apply.)
- 4 Record the outgoing message on your external TAD (see next page).
- 5 Set the TAD to answer calls.
- 6 Set the Receive Mode to **EXT.TEL/TAD**. (See *Choosing the Receive Mode*, page 5-1.)

## Outgoing Message (OGM) on External TAD

Timing is important in recording this message.

- 1 Record 5 seconds of silence at the beginning of your message. (This allows your MFC time to listen for the fax CNG tones of automatic transmissions before they stop.)
- 2 Limit your speaking to 20 seconds.
- 3 End your 20-second message by giving your Fax Receive Code for people sending manual faxes. For example:  
“After the beep, leave a message or send a fax by pressing **\* 51** and Start.”

## Special Line Considerations

### Roll Over Phone Lines

A roll over phone system is a group of two or more separate telephone lines that pass incoming calls each other if they are busy. The calls are usually passed down or “rolled over” to the next available phone line in a preset order.

Your MFC can work in a roll over system as long as it is the last number in the sequence, so the call cannot roll away. Do not put the MFC on any of the other numbers; when the other lines are busy and a second fax call would be received, the fax call is transferred to a line that does not have a fax machine. **Your MFC will work best on a dedicated line.**

### Two-Line Phone System

A two-line phone system is nothing more than two separate phone numbers on the same wall outlet. The two phone numbers can be on separate jacks (RJ11) or combined into one jack (RJ14). Your MFC must be plugged into an RJ11 jack. RJ11 and RJ14 jacks may be equal in size and appearance and both may contain four wires (black, red, green, yellow). To test the type of jack, plug in a two-line phone and see if it can access both lines. If it can, you must separate the line for your MFC. (See *Easy Receive*, page 5-3.)

### Converting Telephone Wall Outlets

There are three ways to convert to an RJ11 jack. The first two ways may require assistance from the telephone company. You can change the wall outlets from one RJ14 jack to two RJ11 jacks. Or, you can have an RJ11 wall outlet installed and slave or jump one of the phone numbers to it.

The third way is the easiest: Buy a triplex adapter. You can plug a triplex adapter into an RJ14 outlet. It separates the wires into two separate RJ11 jacks (Line 1, Line 2) and a third RJ14 jack (Lines 1 and 2). If your MFC is on Line 1, plug the MFC into L1 of the triplex adapter. If your MFC is on Line 2, plug it into L2 of the triplex adapter.

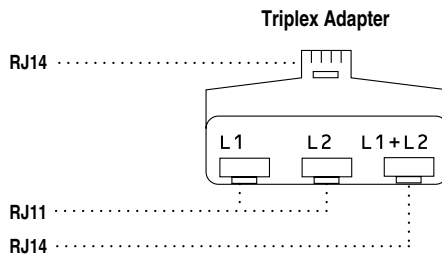

## Installing MFC, External Two-Line TAD and Two-Line Telephone

When you are installing an **external** two-line telephone answering device (TAD) and a two-line telephone, your MFC must be isolated on one line at both the wall jack and at the TAD. *The most common connection is to put the MFC on Line 2.* The two-line TAD must have two telephone jacks: one labeled L1 or L1/L2, and the other labeled L2, which is explained in the following Steps. You will need at least three telephone line cords, the one that came with your MFC and two for your external two-line TAD. You will need a fourth line cord if you add a two-line telephone.

- 1 Place the two-line TAD and the two-line telephone next to your MFC.
- 2 Plug one end of the telephone line cord for your MFC into the L2 jack of the triplex adapter. Plug the other end into the LINE jack on the left side of the MFC.
- 3 Plug one end of the first telephone line cord for your TAD into the L1 jack of the triplex adapter. Plug the other end into the L1 or L1/L2 jack of the two-line TAD.
- 4 Plug one end of the second telephone line cord for your TAD into the L2 jack of the two-line TAD. Plug the other end into the EXT. jack on the left side of the MFC.

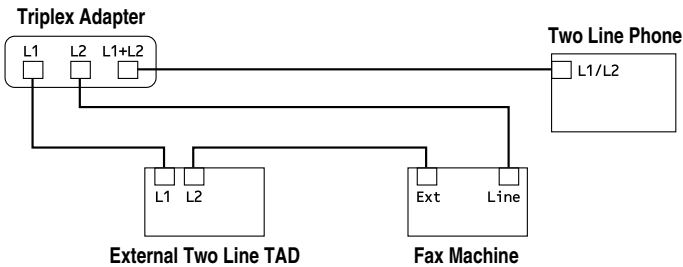

You can keep two-line telephones on other wall outlets as always. There are two ways to add a two-line telephone to the MFC's wall outlet. You can plug the telephone line cord from the two-line telephone into the L1+L2 jack of the triplex adapter. Or, you can plug the two-line telephone into the TEL jack of the two-line TAD.



## Multi-Line Connections (PBX)

Most offices use a central telephone system. While it is often relatively simple to connect the machine to a key system or a PBX (Private Branch Exchange), we suggest that you contact the company that installed your telephone system and ask them to connect the MFC for you. It is advisable to have a separate line for the MFC. You can then leave the MFC in FAX mode to receive faxes any time of day or night.

If the MFC is to be connected to a multi-line system, ask your installer to connect the unit to the last line on the system. This prevents the unit from being activated each time a telephone call is received.

-  As with all fax units, this machine must be connected to a two wire system. If your line has more than two wires, proper connection of the MFC cannot be made.

### If You are Installing the MFC to Work with a PBX:

- 1 It is not guaranteed that the unit will operate correctly under all circumstances with a PBX. Any cases of difficulty should be reported first to the company that handles your PBX.
- 2 If all incoming calls will be answered by a switchboard operator, it is recommended that the Receive Mode be set to **MANUAL**. All incoming calls should initially be regarded as telephone calls.
- 3 The MFC may be used with either pulse or tone dialing telephone service (For Canada only).

## Custom Features on a Your Phone Line

To learn how custom features may affect your faxing operations, See Chapter 20, *Troubleshooting and Routine Maintenance*.

### Custom Features on a Single Line

If you have Voice Mail, Call Waiting, Call Waiting/Caller ID, RingMaster, an answering service, or an alarm system custom feature on one phone line, it may create a problem with the operation of your fax machine. (See *I have difficulty with custom features on a single line.*, page 20-10.)

# 3 On-Screen Programming

## *User-Friendly Programming*

---

We have designed your MFC with on-screen programming using navigation keys. User-friendly programming helps you take full advantage of all the menu selections your MFC has to offer.

Since your programming is done on the LCD, we created step-by-step on-screen prompts to help you program your MFC. All you need to do is follow the prompts as they guide you through the menu selections and programming options. Additionally, you can program settings more quickly by pressing **Menu/Set** and the menu number using the dial pad.

### **Menu Selection Table**





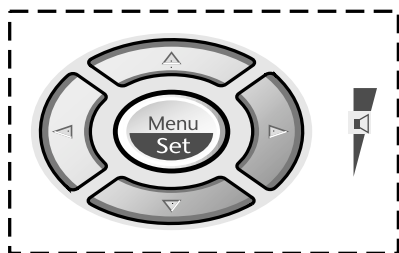

You can probably perform most of these programming operations without the Owner's Manual. To help you understand the menu selections and options that are found in the MFC programs, use the Menu Selection Table on page 3-3.

You can program your MFC by pressing **Menu/Set** followed by the menu number. For example: to set **FAX RESOLUTION** to **FINE**, press **Menu/Set**,

**2, 2, 2** and  to select **FINE**, and then press **Menu/Set**.

# Navigation Keys



-  \* Access the Menu
-  \* Go to next menu level
-  \* Accept an option
-  \* Scroll through the current menu level
-  \* Back to previous menu level
-  \* Forward to next menu level
-  \* Exit the Menu

You can access the menu mode by pressing **Menu/Set**. When you enter the Menu, the LCD scrolls:

SELECT ↑ ↓ & SET

Press **1** for General Setup Menu—**OR**—

1. GENERAL SETUP



Press **2** for Fax Menu—**OR**—

2. FAX



Press **3** for Copy Menu—**OR**—

3. COPY

—**OR**—

You can scroll more quickly through the each menu level by pressing  and then set an option by pressing **Menu/Set** when that option appears on the LCD. Then the LCD shows next menu level. Press  to scroll to your next menu selection, and then press **Menu/Set**.

When you finish setting an option, the LCD shows **ACCEPTED**.

 Use  to scroll backward if you passed your choices or to save keystrokes.

To access the menu, press  **Menu/Set**.

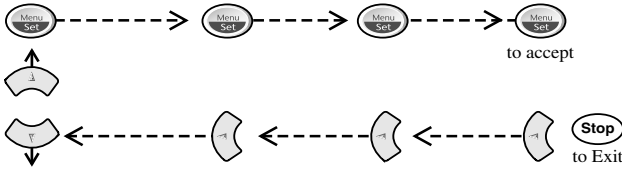







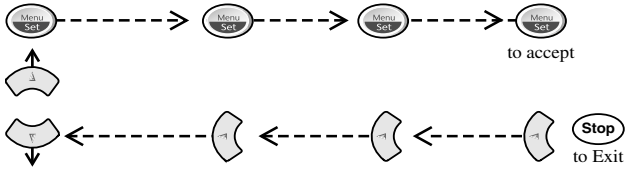

















Main Menu	Submenu	Menu Selections	Options	Descriptions	Page	
<b>1. GENERAL SETUP</b>	<b>1. PAPER SIZE</b>	—	<b>LETTER</b> LEGAL A4	Selects size of paper for received faxes.	4-1	
	<b>2. DATE/TIME</b>	—	—	Enter date and time for the LCD display and heading on fax transmissions.	4-1	
	<b>3. STATION ID</b>	—	—	Program your name, fax number and telephone number to appear on each transmitted page.	4-2	
	<b>4. VOLUME</b>	<b>1. RING</b>	—	<b>OFF</b> LOW MED HIGH	Adjusts ring volume.	4-4
		<b>2. BEEPER</b>	—	<b>OFF</b> LOW HIGH	Adjusts beeper volume.	4-4
		<b>3. SPEAKER</b>	—	<b>ON</b> OFF	Adjust speaker volume	4-4
	<b>5. AUTO DAYLIGHT</b>	—	<b>ON</b> OFF	Changes for Daylight Savings Time automatically.	4-5	
<b>6. TONER SAVE</b>	—	<b>ON</b> OFF	Increases life of toner cartridge.	4-5		
<b>7. SLEEP MODE</b>	—	—	—	Conserves power	4-5	

 The factory setting (option) is shown in bold.

To access the menu, press  **Menu/Set**.



Main Menu	Submenu	Menu Selections	Options	Descriptions	Page
1. GENERAL SETUP (Continued)	8. TONE/ PULSE (Canada Only)	—	TONE  PULSE 	Selects dialing mode	4-5
	9. LOCAL LANGUAGE (Canada Only)	—	ENGLISH  FRENCH 	Allows you to change the LCD Language to French.	See French Manual
2. FAX	1. SETUP RECEIVE	1. RING DELAY	00  01  02  03  <b>04</b>  05 	Number of rings before MFC answers in FAX ONLY mode.	5-2
		2. EASY RECEIVE	ON  OFF 	Receive fax messages without pressing the Fax Start key.	5-3
		3. REMOTE CODE	ON  ( <del>*</del> 51)  OFF 	Activate the MFC from a remote location. You can also personalize these codes.	5-4
		4. AUTO REDUCTION	ON  OFF 	Reduces size of image.	5-3
		5. PRINT DENSITY	-  ■  □  + 	Makes prints darker or lighter.	5-4
		6. POLLING RX	ON  OFF 	Sets up your MFC to poll another fax machine.	5-5

 The factory setting (option) is shown in bold.



To access the menu, press  **Menu/Set**.

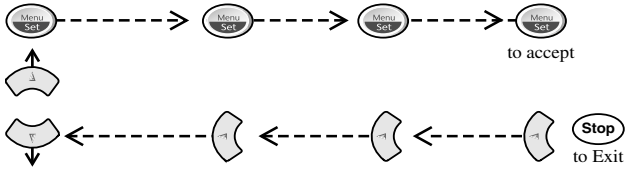

Main Menu	Submenu	Menu Selections	Options	Descriptions	Page
2. FAX (Continued)	2. SETUP SEND (Continued)	9. COVERPAGE MSG	—	Programs customized message for fax cover page.	6-8
		0. OVERSEAS MODE	ON <b>OFF</b>	Adjusts for sometimes difficult overseas transmissions.	6-10
	3. SET AUTO DIAL	1. SPEED-DIAL	—	Store Speed Dial numbers so you can dial by pressing only five keys.	7-1
		2. SETUP GROUPS	—	Sets up a Group number for broadcasting.	7-2
	4. SETUP REPORTS	1. TRANSMISSION	ON ON+IMAGE <b>OFF</b> OFF+IMAGE	Initial setup for Transmission Verification Report and Activity Report.	10-1
		2. ACT. INTERVAL	6/12/24 Hours 2/4/7 Days <b>OFF</b>		10-2
	5. REMOTE FAX OPT	1. FAX FWD/ PAGING	<b>OFF</b> FAX FORWARD PAGING	Sets MFC to forward fax messages— <b>OR</b> — to call your pager.	9-1
		2. FAX STORAGE	ON <b>OFF</b>	Stores incoming faxes in memory for remote retrieval.	9-2
		3. REMOTE ACCESS	159 ✳	Personalizes code for retrieving faxes.	9-3
		4. PRINT FAX	—	Prints incoming faxes stored in the memory.	5-5

 The factory setting (option) is shown in bold.

To access the menu, press  **Menu/Set**.

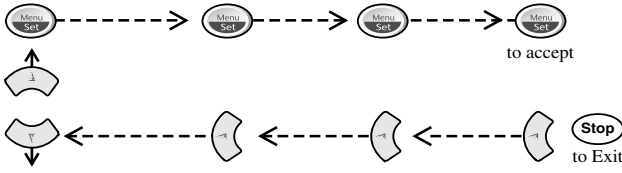

Main Menu	Submenu	Menu Selections	Options	Descriptions	Page
2. FAX (Continued)	6. REMAINING JOBS	—	—	Checks which jobs are in memory or cancel a delayed fax or polling job.	5-6, 6-6
	0. TEL SERVICE	1. DISTINCTIVE	ON <b>OFF</b> SET	Uses the phone company Distinctive Ring subscriber service to register the ring pattern with the MFC.	8-1
		2. CALLER ID	DISPLAY #? PRINT REPORT	View or print a list of the last 30 Caller IDs stored in memory.	8-3
3. COPY	1. COPY MODE	—	<b>AUTO</b> TEXT PHOTO	Selects the Copy resolution for your type of original.	11-9
	2. CONTRAST	—	- ■ ■ ■ □ □ +	Adjusts the contrast.	11-9
	3. PAPER TYPE	—	THIN <b>PLAIN</b> THICK THICKER	Identify the type of paper in the multi-purpose sheet feeder.	11-9

 The factory setting (option) is shown in bold.



# 4 Initial Setup

## Getting Started

---

### Setting Paper Size

You can use three sizes of paper for printing your faxes and copies — letter, legal and A4. When you change the kind of paper you have loaded in the MFC, you will need to change the setting for paper size so your MFC can fit the incoming fax on the page.

- 1 Press **Menu/Set**, **1**, **1**.
- 2 Press  to select **LETTER**, **LEGAL** or **A4**, and then press **Menu/Set**.
- 3 Press **Stop/Exit**.

1. PAPER SIZE

### Setting Date and Time

Your MFC displays the date and time, and prints it on every fax you send. In the event of a power failure, you may have to reset the date and time. All other settings remain unaffected.

- 1 Press **Menu/Set**, **1**, **2**.
- 2 Enter the last two digits of the year, and then press **Menu/Set**.
- 3 Enter two digits for the month (for example, enter 09 for September, or 10 for October), and then press **Menu/Set**.
- 4 Enter two digits for the day (for example, 06), and then press **Menu/Set**.
- 5 Enter the time in 24-hour format (for example, enter 15:25 for 3:25 PM), and then press **Menu/Set**.
- 6 Press **Stop/Exit**.  
The LCD now shows the date and time you set whenever the MFC is in Standby mode.

2. DATE/TIME

YEAR:XX  
ENTER & SET KEY

MONTH:XX  
ENTER & SET KEY

DAY:XX  
ENTER & SET KEY

TIME:XX:XX  
ENTER & SET KEY

## Setting Station IDs

You can store your name, fax number, and telephone number to be printed on all fax pages that you send. (See *Composing Electronic Cover Page*, page 6-8.)

- 1 Press **Menu/Set**, 1, 3.

3.STATION ID

- 2 Enter your fax number (up to 20 digits), and then press **Menu/Set**. You must enter a fax number to proceed.

FAX:  
ENTER & SET KEY

- 3 Enter your telephone number (up to 20 digits), and then press **Menu/Set**.  
If your telephone number and fax number are the same, enter the same number again.

TEL:  
ENTER & SET KEY

-  The telephone number you enter is used only for Cover Page features.  
(See *Composing Electronic Cover Page*, page 6-8.)

- 4 Use the dial pad to enter your name (up to 20 characters), and then press **Menu/Set**.  
(See *Entering Text*, below.)

NAME:  
ENTER & SET KEY

- 5 Press **Stop/Exit**.  
The LCD returns to the date and time.

-  If your Station ID has already been programmed, the LCD prompts “1” to make a change, or “2” to exit without changing.

## Entering Text

When you are setting certain functions, such as the Station ID, you may need to type text into the MFC. Most number keys have three or four letters printed above them. The keys for 0, #, and \* don't have printed letters because they are used for special characters.

By pressing the appropriate number key repeatedly, you can access the character you want.

Press Key	one time	two times	three times	four times
2	A	B	C	2
3	D	E	F	3
4	G	H	I	4
5	J	K	L	5
6	M	N	O	6
7	P	Q	R	S
8	T	U	V	8
9	W	X	Y	Z

## Inserting Spaces

To enter a space, press  once between numbers and twice between characters.



## Making Corrections

If you entered a letter incorrectly and want to change it, press  to move the cursor after the last correct letter. Then press **Stop/Exit**; all letters above and to the right of the cursor will be deleted. Re-enter the correct characters. You can also back up and type over incorrect letters.

## Repeating Letters

If you need to enter a character that is assigned to the same key as the previous character, press  to move the cursor to the right.

## Special Characters and Symbols

Press **\***, **#** or **0**, repeatedly or press  or  to move the cursor under the special character or symbol you want. Then press **Menu/Set** to select it.

Press **\*** for (space) ! “ # \$ % & ’ ( ) \* + , - . /

Press **#** for ; : < = > ? @ [ ] ^ \_

Press **0** for É À È Ê Î Ç Ë Ö 0

## NOTICE

The Telephone Consumer Protection Act of 1991 makes it unlawful for any person to use a computer or electronic device to send any message via a telephone fax machine unless such messages clearly contain, in a margin at the top or bottom of each transmitted page, or on the first page of the transmission, the date and time it is sent and an identification of the business or other entity or other individual sending the message and the telephone number of the sending machines or such business, other entity or individual.

In order to program this information into your fax machine, complete the steps described on page 4-1 and 4-2.



If you do not enter a fax number, no additional information can be entered.

## Setting the Ring Volume

1 Press **Menu/Set, 1, 4, 1.**

1. RING

2 Press  to select (**OFF, LOW, MED** or **HIGH**), and then press **Menu/Set**.

3 Press **Stop/Exit**.

—OR—

You can adjust the ring volume when your MFC is idle. You can turn the ring **OFF** or you can select a ring volume level.

Press  to adjust the volume level. With each key press, the MFC rings so you can hear the active setting as the LCD shows it. Each key press changes the volume. The new setting will remain until you change it again.

## Setting the Beeper Volume

You can set the beeper to **LOW, HIGH** or **OFF**. The default setting is **LOW**. When the beeper is set to **LOW** or **HIGH**, the MFC beeps every time you press a key or make an error and when fax sending or receiving has finished.

1 Press **Menu/Set, 1, 4, 2.**

2. BEEPER

2 Press  to select your option.

3 When the LCD shows the option you want, press **Menu/Set**.

4 Press **Stop/Exit**.

## Setting the Speaker Volume

You can turn off the volume of the MFC one-way speaker.

1 Press **Menu/Set, 1, 4, 3.**

2 Press  to select **ON** (or **OFF**), and then press **Menu/Set**.

3 Press **Stop/Exit**.

## Memory Storage



In the event of a power failure, all settings in the **GENERAL SETUP, SETUP RECEIVE, SET AUTO DIAL, REMOTE FAX OPT**, plus the **COVERPG SETUP** and **COVERPAGE MSG** functions (from **SETUP SEND**) are stored permanently. You may have to reset the date and time.

## Turning On Automatic Daylight Savings Time

You can set the MFC to change automatically for Daylight Savings Time. It will reset itself forward one hour in the Spring and back one hour in the Fall.

- 1 Press **Menu/Set**, **1**, **5**.

5. AUTO DAYLIGHT

- 2 Press  **OR**  to select **ON** (or **OFF**),  
and then press **Menu/Set**.



- 3 Press **Stop/Exit**.

## Toner Save

You can conserve toner using this feature. When you set Toner Save to **ON**, print appears somewhat lighter. The default setting is **OFF**.

- 1 Press **Menu/Set**, **1**, **6**.

6. TONER SAVE

- 2 Press  **OR**  to select **ON** (or **OFF**), and  
then press **Menu/Set**.

- 3 Press **Stop/Exit**.

## Sleep Mode

Setting the Sleep Mode reduces power consumption while the machine is idle. You can choose how long the MFC is idle (from 00 to 99 minutes) before it drops into sleep mode. The timer automatically resets itself after the machine receives a fax or PC data, or makes a copy. The default setting is 0 minutes.

- 1 Press **Menu/Set**, **1**, **7**.

7. SLEEP MODE

- 2 Use the Dial pad to enter the length of  
time the machine is idle before it drops  
into sleep mode (00 to 99 minutes),  
and then press **Menu/Set**.



- 3 Press **Stop/Exit**.

## Setting Tone/Pulse Dialing Mode (For Canada Only)

Your MFC comes set to accommodate tone (multi-frequency) dialing service. If you have pulse (rotary) dialing service, you need to change the dialing mode.

- 1 Press **Menu/Set**, **1**, **8**.

8. TONE/PULSE

- 2 Press  **OR**  to select **TONE** or **PULSE**,  
and then press **Menu/Set**.

- 3 Press **Stop/Exit**.

# 5 Setup Receive

## Basic Receiving Operations

### Choosing the Receive Mode

There are three different receive modes for your MFC. You may choose the mode that best suits your needs by pressing **Receive Mode** repeatedly until the LCD shows the setting you want to use.

LCD	How it works	When to use it
<b>FAX ONLY</b> (automatic receive)	The MFC automatically answers every call as a fax.	For dedicated fax lines. You cannot receive a voice call but you can call out.
<b>EXT.TEL/TAD</b> (manual receive) (With an External Telephone)	If an external telephone is connected to the EXT. jack, you control the phone line and must answer every call yourself.	Use this mode if you receive very few faxes.
(automatic receive) (With an External Telephone Answering Device)	If an external TAD (telephone answering device) is connected to the EXT. jack, the TAD automatically answers every call. Voice messages are stored in the external TAD. Fax messages are printed.	Use this mode if you have an external answering machine on your phone line.
<b>MANUAL</b> (manual receive) (With an External Telephone)	You control the phone line and must answer every call yourself.	Use this mode when you are using a computer modem on the same line or if you receive very few fax messages. You can also use this mode with Distinctive Ring.

## To Select or Change Your Receive Mode

- 1 Press **Receive Mode**. The LCD shows your active setting.

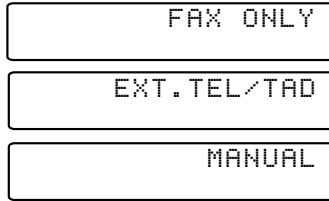

- 2 Continue to press **Receive Mode** until your new selection appears. After two seconds, the LCD returns to the date and time and shows the new Receive Mode.



If you are changing the Receive Mode while in another operation, the LCD returns to that operation.

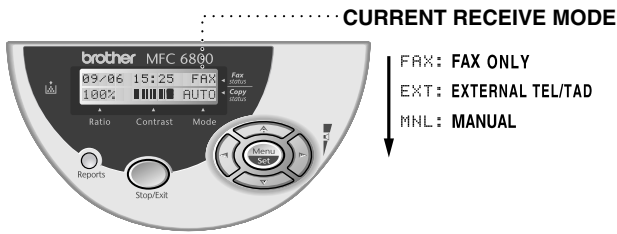

## Setting Ring Delay

The Ring Delay setting determines the number of times the MFC rings before it answers. If you have extension phones on the same line as the MFC, or are using the telephone company's Distinctive Ring service, keep the Ring Delay default setting of **04**. You can try increasing the Ring Delay to **05** rings; however, if you do not receive all your faxes, you must reset it to **04** rings. (See *Easy Receive*, page 5-3 and *Operation from Extension Telephone*, page 5-4.)

- 1 Press **Menu/Set**, **2**, **1**, **1**.

1. RING DELAY

- 2 Press  to select how many times the

line rings before the MFC answers (00–05), and then press **Menu/Set**. If you select 00, the line doesn't ring at all.

- 3 Press **Stop/Exit**.

## Easy Receive

When you use this feature, you don't have to press **Fax Start** when you answer a fax call. Selecting **ON** allows the MFC to receive fax calls automatically, even if you lift the handset of an extension or external phone. When you see **RECEIVING** on the LCD or when you hear "chirps" through the handset of an extension phone connected to another wall jack, just replace the handset, and your MFC does the rest. Selecting **OFF** means you'll have to activate the MFC yourself, by lifting the handset of an external or extension phone, then pressing **Fax Start** on the MFC—**OR**—by pressing **\* 5 1** if you are not at your MFC. (See *Operation from Extension Telephone*, page 5-4.)

**Note** If Easy Receive is **OFF** and an original is in the ADF, lift the handset of an external or extension phone, press **Fax Start**, then **2** to activate the MFC.

**Note** If you've set the feature to **ON**, but your MFC doesn't automatically connect a fax call when you lift an external or extension phone handset, press the Fax Receive code **\* 5 1**.

**Note** If you send faxes from a computer on the same phone line and the MFC intercepts them, set Easy Receive to **OFF**.

**1** Press **Menu/Set, 2, 1, 2**.

2.EASY RECEIVE

**2** Use  to select **ON** or **OFF**, and then press **Menu/Set**.

**3** Press **Stop/Exit**.

## Printing a Reduced Incoming Fax

If you turn on Auto Reduction, the MFC will choose the appropriate reduction percentage for the type of paper you loaded.

**1** Press **Menu/Set, 2, 1, 4**.

4.AUTO REDUCTION



**2** Use  to select **ON** (or **OFF**), and then press **Menu/Set**.

**3** Press **Stop/Exit**.



## Setting the Print Density

If your MFC is printing too light or too dark, you can adjust print density, making your printed documents darker or lighter. The new setting will remain until you change it again.

- 1 Press **Menu/Set, 2, 1, 5.**
- 2 Press  to make print darker or  to make print lighter, and then press **Menu/Set.**
- 3 Press **Stop/Exit.**

5.PRINT DENSITY

## Advanced Receiving Operations

### Operation from Extension Telephone

If you answer a fax call on an extension phone or on an external phone in the EXT. jack, you can make your MFC take over by using the Fax Receive Code. When you press the Fax Receive Code **\* 5 1**, the MFC starts to receive a fax. (See *Easy Receive*, page 5-3.)

If you answer a call at an extension or external phone, and no one is on the line, assume you're receiving a fax. At an extension phone, press **\* 5 1**, wait for fax receiving tones (chirps), then hang up. At an external phone, press **\* 5 1** and wait for the phone to be disconnected (the LCD shows **RECEIVING**) before you hang up. (Your caller will have to press **Fax Start** to send the fax.)

### Changing the Fax Receive Code

The preset Fax Receive Code (**\* 5 1**) might not work with some telephone systems.

 **Note** If you are always disconnected when accessing your external TAD remotely, try changing the Fax Receive Code from **\* 5 1** to **###**.

- 1 Press **Menu/Set, 2, 1, 3.**
- 2 Press  to select **ON** (or **OFF**), and then press **Menu/Set.**
- 3 If you want to, enter a new Fax Receive Code, and then press **Menu/Set.**
- 4 Press **Stop/Exit.**

3.REMOTE CODE

REMOTE ACT.:ON?  
SELECT ↑ ↓ & SET

FAX RECEIVE:\*51  
ENTER & SET KEY

## Printing a Fax in Memory

If you have Fax Storage ON for remote retrieval, you can still print a fax from the memory when you are at your MFC. (See *Setting Fax Storage*, page 9-2.)

- 1 Press **Menu/Set, 2, 5, 4.**
- 2 Press **Fax Start.**
- 3 After printing is finished, press **Stop/Exit.**



4.PRINT FAX

## Polling

Polling is the process of retrieving faxes from another fax machine. You can use your MFC to “poll” other machines, or you can have someone poll your MFC.



All parties involved in polling need to set up their fax machines to accommodate polling. When someone polls your MFC to receive a fax, they pay for the call; if you poll someone’s fax machine to receive a fax, you pay for the call.



Some fax machines do not respond to the polling function.

## Setting Up Polling Receive

Polling Receive is when you call another fax machine to receive a fax from it.

- 1 Press **Menu/Set, 2, 1, 6.**
- 2 Press  **OR**  to choose **ON** (or **OFF**), and then press **Menu/Set.**
- 3 Enter the fax number you are polling.
- 4 Press **Fax Start.**  
The LCD shows **DIALING.**



6.POLLING RX

## Setting Up Sequential Polling Receive

Your MFC can request documents from several fax units in a single operation. Afterward, a Sequential Polling Report will be printed.

- 1 Press **Menu/Set, 2, 1, 6.**

6. POLLING RX

- 2 Press  to select **ON** (or **OFF**), and then press **Menu/Set**.

- 3 Specify the destination fax machines you wish to poll using Speed Dial, a Group or the dial pad. You must press **Menu/Set** between each location.

ENTER FAX NO.  
PRESS FAX START

- 4 Press **Fax Start**.

The LCD shows **DIALING**.

Your MFC will poll each number or group number in turn for a document.

## Canceling a Scheduled Job

You can cancel tasks you've scheduled, such as Delayed Fax or Polling Transmit. (See *Checking Job Status*, page 6-6.)

- 1 Press **Menu/Set, 2, 6**. Any waiting jobs appear on the LCD. If no job is waiting, the LCD shows **NO JOB WAITING**.

6. REMAINING JOBS

- 2 If you have more than two jobs waiting, press  to select the job you want to cancel, and then press **Menu/Set**.

—OR—

If you have only one job waiting, go to Step 3.

- 3 Press **1** to cancel—OR—Press **2** to exit without canceling. To cancel another job, return to Step 2.

- 4 Press **Stop/Exit**.

# 6 Setup Send

## Before You Begin

---

You can send a fax from the ADF (Automatic Document Feeder) or from the scanner glass.

### Sending Faxes Using Multiple Settings

When you send a fax you can choose any combination of the available settings: add a cover page and select a comment; set the contrast or resolution; send using overseas mode, or delayed fax timer, polling transmission or real time transmission. After each menu selection is accepted, the LCD will ask if you want to enter other settings:

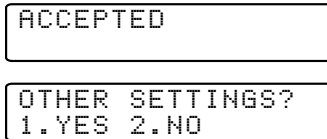

Press **1** if you want to select additional settings. The LCD returns to the **SETUP SEND** menu—**OR**—Press **2** if you are finished choosing settings, and go to the next step.

### Faxing from the ADF (Automatic Document Feeder)

The ADF can hold up to 30 pages, feeding each one individually through the MFC. Use standard (20 lb/75g/m<sup>2</sup>) paper when using the ADF. Always fan the pages well before placing them in the feeder.

### Recommended Environment

Temperature: 68°F – 86°F (20°C – 30°C)  
Humidity: 50% – 70%  
Paper: Xerox 4200 (20LB/LTR)

 **DO NOT** use curled, wrinkled, folded, ripped paper, or paper with staples, paper clips, paste or tape attached. **DO NOT** use cardboard, newspaper, or fabric. (To fax this kind of document, see *Faxing from the Scanner Glass*, page 6-3.)

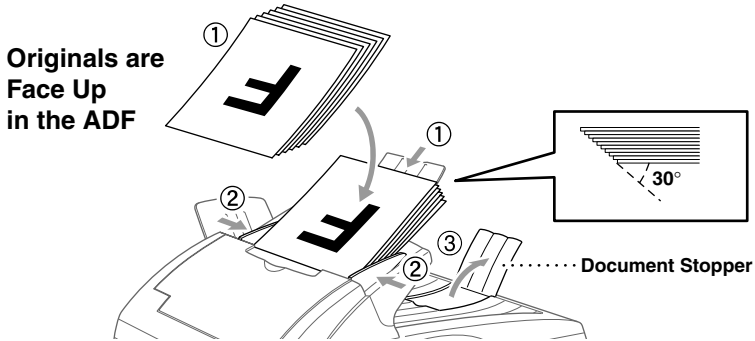

- Make sure documents written with ink are completely dry.
- Before you send a fax, press **Fax Resolution** to select the resolution for the document you're sending. (See *Fax Resolution*, page 6-7.)

- Originals to be faxed must be from 5.8 to 8.5 inches wide, and 5.8 to 14 inches long.
- 1 Fan the pages and stagger them at a 30 degree angle. Insert the pages **face up, top edge first** in the ADF until you feel them touch the feed roller.
  - 2 Adjust the paper guides to fit the width of your original.



- 3 Unfold the document stopper.

## Setting the Special Media Lever

You can use the special media lever to select the Regular position (  ) or Special position. (  )

To feed special types of originals (such as coated paper or glossy paper), move the special media lever to the Special position (  ). It will allow the original to feed through the ADF without slipping or jamming.

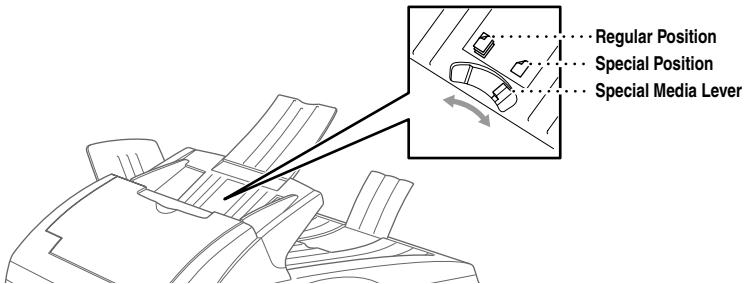

If the original “double-feeds”, try again by inserting a single sheet of original in the ADF or use Scanner glass.

## Faxing from the Scanner Glass

You can use the scanner glass to fax one page at a time or pages of a book. Originals can be letter or A4 size (8.5 inches to 11.7 inches).

! To use the scanner glass, the ADF must be empty.

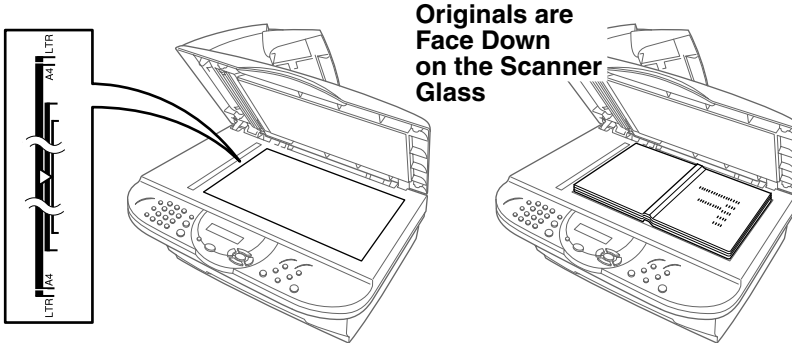

- 1 Lift the document cover.
- 2 Using the document guidelines on the left, center the original face down on the scanner glass.
- 3 Close the document cover.

! If the original is a book or is thick, do not slam the cover or press on it.

- 4 Dial the fax number, and then press **Fax Start**. The MFC starts scanning the first page.
- 5 To send a single page, go to Step 7  
—OR— To send multiple pages, go to Step 6.

MEMORY #01 100%

NEXT:PRESS SET  
DIAL:PRESS START

- 6 Place the next page on the scanner glass, and then press **Menu/Set**. The MFC starts scanning. (Repeat this step for each additional page.)
- 7 Press **Fax Start** to begin dialing.



Press **Stop/Exit**. If the original was scanned into memory, press **1** to clear it  
—OR— Press **2** to exit.

1. CLEAR 2. EXIT



If memory is full, and you are faxing a single page, it will be sent in real time.

## Manual Transmission (With an External Telephone)

Manual transmission lets you hear the dial tone, ringing and fax receiving tones before sending the fax.

- 1 Place the original face up in the ADF, or face down on the scanner glass.
- 2 Pick up the handset of the external phone and listen for a dial tone.
- 3 Enter the fax number you want to call. (You can enter the digits using the dial pad, Speed Dial or Search).
- 4 When you hear the fax tone, press **Fax Start**.
- 5 Replace the handset of the external phone.

## Automatic Transmission

This is the easiest way to send a fax.

- 1 Place the original face up in the ADF, or face down on the scanner glass.
- 2 Enter the fax number using the dial pad, Speed Dial or Search.  
(See *Speed Dialing*, page 7-3.)
- 3 Press **Fax Start**.

## Manual and Automatic Fax Redial

*If you're sending a fax manually* and the line is busy, press **Redial/Pause** to try again. Anytime you want to make a second call to the last number dialed, press **Redial/Pause** to save time.

*If you're sending a fax automatically* and the line is busy, the MFC will automatically redial (up to three times at 5 minute intervals).

## Dual Access

You can place an original in the ADF and set temporary settings, dial a number, and begin scanning the fax into memory—even when the MFC is receiving a fax, sending a fax, or printing a fax from memory. The LCD shows the new job number and available memory.



If you get a **OUT OF MEMORY** message while scanning the first page of a fax, press **Stop/Exit** to cancel scanning. If you get a **OUT OF MEMORY** message while scanning in a subsequent page, you'll have the option to press **Fax Start** to transmit the pages scanned so far, or to press **Stop/Exit** to cancel the operation.

- 1 Place the original face up in the ADF.
- 2 Enter the fax number.

- 3 Press **Fax Start**. The MFC starts scanning the original and the LCD shows the job number (#XX) of the fax and how much memory is available. Then the machine starts dialing. For the next fax, you can repeat steps 1 through 4 immediately.



Your MFC normally operates in Dual Access mode.



The number of pages you can scan into memory varies with the data they contain.

## Real Time Transmission

When you are sending a fax, the MFC will scan originals into memory before sending. Then, as soon as the phone line is free, the MFC will start dialing and sending the fax. If memory becomes full, the MFC will send the document in real time (even if **REAL TIME TX** is set to **OFF**).

Sometimes you may want to send an important document immediately, without waiting for memory transmission. You can set **REAL TIME TX** to **ON**.

- 1 Place the original face up in the ADF, or face down on the scanner glass.
- 2 Press **Menu/Set, 2, 2, 6**.

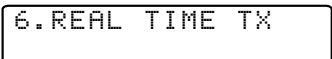

6. REAL TIME TX

- 3 To change the default setting, press  to select **ON** (or **OFF**), and then press **Menu/Set**.

Go to Step 5—**OR**—For the next fax transmission only, press  to select **NEXT FAX ONLY**, and then press **Menu/Set**.



- 4 For the next fax only, press  to select **ON** (or **OFF**), and then press **Menu/Set**.



- 5 Press **1** if you want to select additional settings. The LCD returns to the **SETUP SEND** menu—**OR**—Press **2** if you are finished choosing settings, and go to Step 6.
- 6 Enter fax number, and then press **Fax Start**.

## Checking Job Status

Check which jobs are still waiting in memory to be sent. (If no jobs are waiting, the LCD shows **NO JOB WAITING**.) (See *Canceling a Job in Memory* below.)

- 1 Press **Menu/Set, 2, 6**.
- 2 If you have multiple jobs waiting, press  **OR**  to scroll through the list.
- 3 Press **Stop/Exit**.



6. REMAINING JOBS

## Canceling a Job While Scanning the Original

You can cancel a job while you are scanning it into memory by pressing **Stop/Exit**. Eject the original by pressing **Stop/Exit** again.

## Canceling a Job in Memory

You can cancel tasks you've scheduled, such as Polling Transmit or faxes waiting in Memory to be sent. (See *Checking Job Status* above.)

- 1 Press **Menu/Set, 2, 6**. Any waiting jobs appear on the LCD. If no jobs are waiting, the LCD shows **NO JOB WAITING**.
- 2 If you have more than two jobs waiting, press  **OR**  to select the job you want to cancel, and then press **Menu/Set**.  
—**OR**—  
If you have only one job waiting, go to Step 3.
- 3 Press **1** to cancel—**OR**—Press **2** to exit without canceling. To cancel another job, return to Step 2.
- 4 Press **Stop/Exit**.



6. REMAINING JOBS

# Basic Sending Operations

---

## Contrast

If your document is very light or very dark, you might want to set the contrast. Use **S.LIGHT** to send a very light document. Use **S.DARK** to send a very dark document.



- 1 Place the original face up in the ADF, or face down on the scanner glass. 
- 2 Press **Menu/Set, 2, 2, 1**.
- 3 Press  to select **AUTO, S.LIGHT** or **S.DARK**, and then press **Menu/Set**.
- 4 Press **1** if you want to select additional settings. The LCD returns to the **SETUP SEND** menu—**OR**—Press **2** if you are finished choosing settings, and then go to Step 5.
- 5 Enter a fax number.
- 6 Press **Fax Start** to send a fax.

## Fax Resolution

When you have a document in the ADF, or on the scanner glass you can use the **Fax Resolution** key to change the setting temporarily (for this fax only) Press **Fax Resolution** repeatedly until the LCD shows the setting you want.

—OR—

You can change the default setting.

- 1 Press **Menu/Set, 2, 2, 2**. 
- 2 Press  to select the resolution you want, and then press **Menu/Set**.
- 3 Press **Stop/Exit**.  
**STANDARD**—Suitable for most typed documents.  
**FINE**—Good for small print; transmits a little slower than Standard resolution.  
**S. FINE**—Good for small print or artwork; transmits slower than Fine resolution.  
**PHOTO**—Use when original has varying shades of gray; slowest transmission time.

## Composing Electronic Cover Page

The cover page is generated at the receiving party's machine. Your cover page includes the name stored in the Speed Dial memory. If you're dialing manually, the name is left blank.

The cover page indicates your Station ID, and the number of pages you're sending. If you have Cover page Setup set to ON, the number of pages remains blank. (**Menu/Set, 2, 2, 8.**) (See *Setting Station IDs*, page 4-2.)

You can select a comment to include on your cover page.

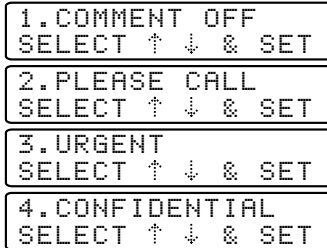

Instead of using one of the comments above, you can enter up to two customized messages, each 27 characters long. Use the chart on page 4-2 to help enter characters. (See *Composing Your Own Comments* below.)

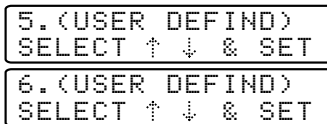

Most of the **SETUP SEND** menu selections are temporary settings that allow you to make adjustments for each document you send. However, so you can set up your cover page and cover page comments in advance, the Cover Page Setup and Cover Page Message functions will change the default settings.

### Composing Your Own Comments

You can set up two custom comments.

- 1 Press **Menu/Set, 2, 2, 9.**

9. COVERPAGE MSG

- 2 Press  to choose position 5 or 6 for your customized comment, and then press **Menu/Set.**



- 3 Use the dial pad to enter your customized comment, and then press **Menu/Set.** (See *Entering Text*, page 4-2.)

- 4 Press **1** if you want to select additional settings. The LCD returns to the **SETUP SEND** menu—**OR**—Press **2** to exit.

## Cover Page for Next Fax Only

Make sure the Station ID is set up (see page 4-2). This feature does not work without the Station ID.

You can set the fax to send a cover page with a particular document. This cover page will include the number of pages in your document.



- 1 Place the original face up in the ADF, or on the scanner glass.
- 2 Press **Menu/Set, 2, 2, 8.**
- 3 When LCD shows **NEXT FAX ONLY?**, press **Menu/Set.**
- 4 Press  to select **ON** (or **OFF**), and then press **Menu/Set.**
- 5 Press  to select one of the standard or custom comments, and then press **Menu/Set.**
- 6 Enter two digits to indicate the number of pages you are sending, and then press **Menu/Set.** (For example, press **0, 2** for 2.)  
(Enter **00** to leave the number of pages blank. If you make a mistake, press  to back up and reenter the number of pages.)
- 7 Press **1** if you want to select additional settings. The LCD returns to the **SETUP SEND** menu—**OR**—Press **2** if you are finished choosing settings, and then go to Step 8.
- 8 Enter the fax number you're calling.
- 9 Press **Fax Start.**



## Always Send Cover Page

Make sure the Station ID is set up (see page 4-2). This feature does not work without the Station ID.

You can set the MFC to send a cover page whenever you send a fax. The number of pages in your fax is not included when you use this setting.

- 1 Press **Menu/Set, 2, 2, 8.**
- 2 Press  to select **COVERPAGE:ON?**, and then press **Menu/Set.**
- 3 If you selected ON, press  to select one of the standard or custom comments, and then press **Menu/Set.**
- 4 Press **1** if you want to select additional settings. The LCD returns to the **SETUP SEND** menu—**OR**—Press **2** to exit if you are finished choosing settings.

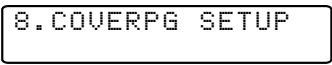

## Using a Printed Cover Page

If you prefer using a printed cover page that you can write on, you can print the sample page and attach it to your fax.

- 1 Press **Menu/Set**, **2**, **2**, **8**.

8. COVERPG SETUP

- 2 Press  to select **PRINT SAMPLE?**,  
and then press **Menu/Set**.

- 3 Press **Fax Start**. Your MFC prints a copy of your cover page.

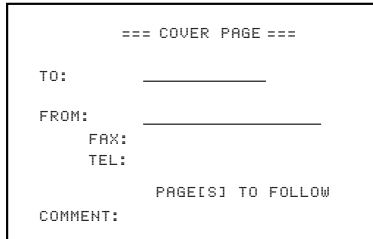

=== COVER PAGE ===

TO: \_\_\_\_\_

FROM: \_\_\_\_\_

FAX: \_\_\_\_\_

TEL: \_\_\_\_\_

PAGE[S] TO FOLLOW

COMMENT: \_\_\_\_\_

## Advanced Sending Operations

---

### Overseas Mode

After you send a fax using this feature, the feature turns itself off.

- 1 Place the original face up in the ADF, or face down on the scanner glass.

- 2 Press **Menu/Set**, **2**, **2**, **0**.

0. OVERSEAS MODE

- 3 Press  to select **ON** (or **OFF**),  
and then press **Menu/Set**.

- 4 Press **1** if you want to select additional settings. The LCD returns to the **SETUP SEND** menu—**OR**—Press **2** if you are finished choosing settings, and then go to Step 5.

- 5 Enter the fax number you're calling.

- 6 Press **Fax Start**.

## Delayed Timer

You can set up the time of day that delayed faxes will be sent. This time will be displayed for acceptance or you can override it in *Delayed Fax*.

(See *Delayed FAX*, below.)

- 1 Press **Menu/Set, 2, 2, 3**.
- 2 Enter the time that you want delayed faxes to be sent (in 24-hour format), and then press **Menu/Set**.
- 3 Press **Stop/Exit**.



3.DELAYED TIMER

## Delayed FAX

During the day you can store *up to* 50 documents in memory for delayed sending. Transmission of these documents will begin at the time of day you enter in Step 3, which shows the time you entered last. Press **Menu/Set** to accept it, or enter another time for this fax.

- 1 Place the original face up in the ADF, or on the scanner glass.
- 2 Press **Menu/Set, 2, 2, 4**.
- 3 Enter the time you want the fax to be sent (in 24-hour format), and then press **Menu/Set**.  
(For example, enter 19:45 for 7:45 P.M.)
- 4 Press **1** if you want to select additional settings. The LCD returns to the **SETUP SEND** menu—**OR**—Press **2** if you are finished choosing settings.
- 5 Enter the fax number.
- 6 Press **Fax Start**. The MFC starts scanning the document into memory. It will wait until the time you have entered to send the fax.



4.DELAYED FAX



*The number of documents you can scan into memory varies with the data they contain.*

## Delayed Batch Transmission

Before sending the delayed faxes, your Brother machine will economize by sorting all the documents in memory by destination and scheduled time. All delayed faxes scheduled at the same time to the same fax number will be sent as one transmission.

- 1 Press **Menu/Set**, **2**, **2**, **5**.
- 2 Press  to select **ON** (or **OFF**), and then press **Menu/Set**.
- 3 Press **Stop/Exit**.



5. BATCH TX

## Setting Up Polled Transmit

Polled Transmit is when you set up your MFC to wait with a document so another fax machine can retrieve it.

- 1 Place the original to be retrieved face up in the ADF, or face down on the scanner glass.
- 2 Press **Menu/Set**, **2**, **2**, **7**.
- 3 Press  to choose **POLLED TX:ON?**, and press **Menu/Set**.
- 4 If you want to select additional settings, press **1**. The LCD returns to the **SETUP SEND** menu—**OR**—Press **2** if you are finished choosing settings.
- 5 Press **Fax Start** and wait for the fax to be polled.

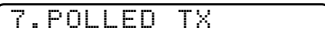

7. POLLED TX

# 7 Auto Dial Numbers and Dialing Options

## Storing Numbers for Easy Dialing

You can set up your MFC for easy dialing: Speed Dial and Groups for Broadcasting faxes.



*If you loose electrical power, auto dial numbers in memory will **not** be lost.*

### Storing Speed Dial Numbers

You can store Speed Dial numbers, so when you dial you have to press only five keys. (**Search/Speed Dial**, **#**, the two-digit location, and **Fax Start**). The MFC has 100 Speed Dial locations.



(For USA Only) Speed Dial **#1** has been pre-programmed for the Brother fax-back system. Speed Dial **#2** has been pre-programmed for the CallManage long distance plan. You can override them if you wish.

1 Press **Menu/Set**, **2, 3, 1**.

```
SPEED-DIAL? #  
ENTER & SET KEY
```

2 Use the dial pad to enter a two-digit location (00-99), and then press **Menu/Set**.

```
#05:  
ENTER & SET KEY
```

3 Enter the number (up to 20 digits), and then press **Menu/Set**.

4 Use the dial pad to enter the name (up to 15 characters), and then press **Menu/Set**.

```
NAME:  
ENTER & SET KEY
```

You can use the chart on page 4-2 to help you enter letters—**OR**—Press **Menu/Set**, and then go to Step 6 to store the number without a name.

5 Return to Step 2 to store another Speed Dial number—**OR**—Press **Stop/Exit**.

### Changing Speed Dial Numbers

If you try to store a Speed Dial number in a location where a number is already stored, the LCD shows the current name stored there, then prompts you to either:



```
#05:XXXXXX  
1.CHANGE 2.EXIT
```

1 Press **1** to change the stored number—**OR**—press **2** to exit without making a change.

2 Enter a new number, and then press **Menu/Set**.

- If you want to erase the whole number, press **Stop/Exit** when the cursor is to the left of the digits. The letters above and to the right of the cursor will be deleted.



- If you want to change a digit, use  or  to position the cursor under the digit you want to change, and then type over it.

- 3 Follow the directions beginning at Step 4 in *Storing Speed Dial Numbers*.

## Setting Up Groups for Broadcasting

Groups allow you to send the same fax message to many fax numbers by pressing only five keys (**Search/Speed Dial**, **#**, the two-digit location, and **Fax Start**). **First**, you'll need to store each fax number as a Speed Dial number. **Then**, you can combine them into a Group. Each Group uses up a Speed Dial number. You can have up to six Groups, or you can assign up to 99 numbers to one large Group.

(See *Storing Speed Dial Numbers*, page 7-1 and *Broadcasting*, page 7-5.)

- 1 Press **Menu/Set**, **2**, **3**, **2**.

2.SETUP GROUP

- 2 Press **Search/Speed Dial**, followed by the two-digit location where you wish to store the Group number, and then press **Menu/Set**.

PRESS SPEED DIAL

SPEED-DIAL? #  
ENTER & SET KEY

(For example, press **Search/Speed Dial**, **07**.)

- 3 Use the dial pad to enter the Group number, and then press **Menu/Set**. (For example, press **1** for Group 1.)

- 4 To include Speed Dial numbers in the Group, enter them as if you were dialing. For example, for Speed Dial location 05, 09, press the **Search/Speed Dial**, **0**, **5** and **Search/Speed Dial**, **0**, **9** on the dial pad. The LCD shows **#05#09**.

G01:#05#09\_  
ENTER & SET KEY

- 5 Press **Menu/Set** to accept the numbers for this Group.

NAME:  
ENTER & SET KEY

- 6 Use the dial pad and the chart on page 4-2 to enter a name for the Group and then press **Menu/Set**. (For example, **NEW CLIENTS**).

- 7 Press **Stop/Exit**.



You can print a list of all Speed Dial numbers. (See Chapter 10, *Printing Reports*.)



## Dialing Options

---

You can use your MFC to make telephone calls by dialing manually or by using Search or Speed Dial memory. When you dial an auto dial number, the LCD shows the name you've stored, or if you haven't stored a name, the fax number you've stored.

### Search

You can search for names you have stored in Speed Dial memory. (See *Storing Speed Dial Numbers*, page 7-1.)

- 1 Place the original face down in the ADF, or face down on the scanner glass.
- 2 Press **Search/Speed Dial**.
- 3 To search for numbers alphabetically by name, enter the first letter of the name, and then press  or .

—OR—

To search for numbers numerically by Speed-Dial number, press .

- 4 When the LCD shows the name you want to call, press **Fax Start**.

### Speed Dialing

- 1 Place the original face up in the ADF, or face down on the scanner glass.
- 2 Press **Search/Speed Dial**, press **#**, then press the two-digit Speed Dial location. (See *Storing Speed Dial Numbers*, page 7-1.)
- 3 Press **Fax Start**.

## Access Codes and Credit Card Numbers

Sometimes you may want to choose from among several long distance carriers when you make a call. Rates may vary depending upon the time and destination. To take advantage of low rates, you can store the access codes or long-distance carriers as Speed-Dial numbers. You can store these long dialing sequences by dividing them and setting them up on separate keys in any combination. You can even include manual dialing using the dial pad. The combined number will be dialed in the order you entered it, as soon as you press **Fax Start**. (See *Storing Speed Dial Numbers*, page 7-1.)

You can store “555” on Speed Dial #03 and “7000” on Speed Dial #02. If you press **Search/Speed Dial, #, 0, 3, Search/Speed Dial, #, 0, 2, and Fax Start**, you can dial “555-7000”. To temporarily change a number, you can substitute part of the number with manual dialing using the dial pad. For example, to change the number to 555-7001 you could press **Search/Speed Dial, #, 0, 2** and then press **7, 0, 0, 1** on the dialing pad.



If you must wait for another dial tone at any point in the dialing sequence, store a pause at that point in the number by pressing **Redial/Pause**. Each key press adds a 3.5 second delay.

### Pause

Press **Redial/Pause** to insert a 3.5 second pause between numbers. If you are dialing overseas, you can press **Redial/Pause** as many times as needed to increase the length of the pause.

### Fax Redial

If you're sending a fax manually and the line is busy, press **Redial/Pause** to try again. Anytime you want to make a second call to the last number dialed, press **Redial/Pause** to save time.

If you're sending a fax automatically and the line is busy, the MFC will redial automatically up to three times at 5 minute intervals.

### Tone/Pulse (For Canada only)

If you have Pulse dialing service, but need to send tone signals (for example, for telephone banking), follow the directions below. If you have Touch Tone service, you will not need this feature to send tone signals.

- 1 Lift the handset of an external phone.
- 2 Press **#**. Any digits dialed after this send tone signals.
- 3 When you hang up, the MFC returns to pulse dialing service.

## Broadcasting

Broadcasting is automatically sending the same fax message to multiple fax numbers. Using the **Broadcast** key, you can include Groups locations, Speed Dial locations and up to 50 manually dialed numbers. If you did not use up any locations for Groups, access codes or credit card numbers, you can "broadcast" faxes automatically to up to 150 different locations from the MFC. However, available memory will vary with all types of jobs in memory and numbers of locations used for broadcasting. If you broadcast to more than the maximum locations available, you will not be able to set up transmissions using dual access and the timer.

The easiest way to broadcast is to press Group keys. You can include Speed Dial and manually dialed numbers in the same broadcast. (See *Setting Up Groups for Broadcasting*, page 7-2.)

You must press **Broadcast** between each of these locations.

Use the **Search/Speed Dial** to help you choose the numbers easily.

After the broadcast is finished, a Broadcast Report will be printed automatically to let you know the results.

- Enter the long dialing sequence numbers as you normally would. Keep in mind that each key counts as one location, so the number of locations you can call becomes limited.
  - If the line is busy or for other reasons a connection could not be made while broadcasting, the MFC will redial the number automatically.
  - If the memory is full, press **Stop/Exit** to abort the job; if more than one page has been scanned, press **Fax Start** to send the portion that is in the memory.
- 1 Place the original face up in the ADF, or face down on the scanner glass.
  - 2 Enter a number using Speed Dial, Group number or Search or the dial pad.  
Example: Group number
  - 3 Press **Broadcast**. You will be prompted to press the next number.
  - 4 Enter the next number.  
Example: Speed Dial
  - 5 Press **Broadcast**.
  - 6 Enter the fax number.  
Example: Manual dialing using the dial pad.
  - 7 Press **Fax Start**.  
Your MFC will read the original into memory and then start sending faxes to the numbers you entered.

## Custom Features

---

Your MFC supports the Distinctive Ring and Caller ID telephone services offered by some telephone companies.



If you have Voice Mail, Call Waiting, RingMaster, an answering service, or an alarm system custom feature on your telephone line, it may create a problem in the operation of your MFC. (*See I have difficulty with custom features on a single line., page 20-10.*)

If you have Voice Mail on your phone line, please read the following carefully.

### Distinctive Ring

The term “Distinctive Ring” is used by Brother to identify a phone company service that is given *many names, depending on the telephone company you are using*. For example, this service may be called SmartRing, RingMaster, Teen-Ring, Indent-a-Call or Indent-a-Ring.

#### What Does Your Telephone Company’s “Distinctive Ring” Do?

Your telephone company’s Distinctive Ring service allows more than one number on the same phone line. **If you need more than one phone number, it is an inexpensive alternative to paying for an additional line.** Each phone number has its own distinctive ring pattern, so you will know which phone number is ringing. This is one way you can have a separate phone number for your MFC.



Please consult your telephone company for availability and rates.

#### What Does Brother’s “Distinctive Ring” Do?

The Brother machine has a Distinctive Ring feature that allows you to use your MFC to take full advantage of the telephone company’s Distinctive Ring service. You can dedicate the new phone number on your line to receiving only faxes.



You must purchase your telephone company’s Distinctive Ring service *before* you program the MFC to work with it.

## Do You Have Voice Mail?

If you have Voice Mail on the phone line on which you will install your new MFC, *there is a strong possibility that Voice Mail and the MFC will conflict with each other while receiving incoming calls.* **However, this Distinctive Ring feature allows the use of more than one number on your line, so both Voice Mail and the MFC can coexist peacefully.** If each one has a separate phone number, neither will interfere with the other's work.

If you decide to get the Distinctive Ring Service from the telephone company, you will need to follow the directions below to “register” the new Distinctive Ring pattern they provided, so your fax machine can recognize its incoming calls.



You can change or cancel the Distinctive Ring pattern at any time. You can switch it off temporarily and later turn it back on. When you get a new fax number, make sure you reset this feature.

## Before You Choose the Ring Pattern to Register

You can register only one Distinctive Ring pattern with the MFC. Some ring patterns cannot be registered. Please refer to some popular ring pattern examples that will be provided from the phone company in the USA and Canada that are shown in the Brother compatibility table below.

Ring Pattern	Rings	
1	long - long	
2	short - long - short	
3	short - short - long	
4	very long (normal pattern)	







If the ring pattern the phone company provided cannot be registered by the fax, **please check for other available ring pattern choices from the phone company.**

- The MFC will answer only calls to its registered number.
- The first two rings are silent on the fax machine. This is because the fax must «listen» to the ring pattern (compare it to the pattern that was “registered”).
- If you program the MFC correctly, it will recognize the registered ring pattern of the “fax number” within 2 ring patterns and then automatically answer with a fax tone. When the “voice number” is called, the fax machine will not interrupt the call.

## VERY IMPORTANT

If you have Voice Mail or a TAD (Telephone Answering Device) and want to keep one of your phone numbers dedicated only to fax calls, you must leave the MFC in **MANUAL** mode at all times while using the Distinctive Ring Feature. Here's why: **MANUAL** mode will never pick up a call by itself, since it is «Neutral». When the MFC is in this «neutral» mode, the Distinctive Ring Feature can be activated. The distinctive ring feature is actually an answering mode. So, do not activate **FAX ONLY** mode or **EXT. TEL/TAD** mode while using distinctive ring; otherwise, the fax machine will answer calls for *all* the numbers.

### Registering the Distinctive Ring Pattern

- 1 Set the MFC to **MANUAL** mode.
- 2 Press **Menu/Set, 2, 0, 1**.  

- 3 Press  **OR**  to select **DISTINCTIVE:SET?**, and then press **Menu/Set**.
- 4 Press  **OR**  to select the prestored ring pattern you want to assign, and then press **Menu/Set**. (You will hear each pattern as you scroll through the four patterns.) Be sure to choose the pattern assigned by the Telephone Company.
- 5 Press **Stop/Exit**.

### Caller ID



The Caller ID feature lets you use the Caller ID subscriber service offered by many local telephone companies. This service provides you, by means of the LCD, the name or telephone number of your caller as the line rings.

After a few rings, the LCD shows the telephone number of your caller (or name, if available). Once you pick up the handset, the Caller ID information disappears from the LCD, but the call information remains stored in the Caller ID memory.

- You will see the first 16 characters of the number (or name).
- **OUT-OF-AREA** display means call originates outside your Caller ID service area.
- **PRIVATE CALL** display means the caller has intentionally blocked transmission of information.
- **CALL PICKUP** display remains on the LCD when no Caller ID information was transmitted.

If both the name and number are received, the LCD shows only the name. You can print a list of Caller ID information received by your MFC. (See *Printing Caller ID List*, page 8-4.)

Caller ID service varies with different carriers. Call your local telephone company to determine the kind of service available in your area.

### Viewing Caller ID List

Caller ID memory stores information for up to thirty calls; when the thirty-first call comes in, information about the first call is erased. You can scroll through Caller ID information to review those calls made to your MFC.

- 1 Press **Menu/Set, 2, 0, 2.**

2.CALLER ID

- 2 Press  to select **DISPLAY #?**, and then press **Menu/Set.**

If the name was not received, it will not be displayed.

- 3 Press  to scroll through the Caller ID memory to select the Caller ID you want to view, and then press **Menu/Set.** The LCD shows the caller's name and number and the date and time of the call.

- 4 Press  to return to the Caller ID listing—**OR**—Press **Stop/Exit.**

### Printing Caller ID List

- 1 Press **Menu/Set, 2, 0, 2.**

2.CALLER ID

- 2 Press  to select **PRINT REPORT ?**, and then press **Menu/Set.**

- 3 Press **Fax Start.**



# 9

# Remote Fax Options

## Fax Forwarding/Paging



You cannot use Paging and Fax Forwarding at the same time.  
You cannot use Paging and Fax Forwarding when Fax Storage is set to **OFF**.

### Programming a Fax Forwarding Number

When Fax Forwarding is set to ON, your MFC stores the received fax in memory, then dials the fax number you've programmed and forwards the fax message.

- 1 Press **Menu/Set, 2, 5, 1**.

1.FAX FWD/PAGING

- 2 Press  until the LCD shows **FAX FORWARD?**, and then press **Menu/Set**.

- 3 The LCD prompts you to enter the number of the fax machine where faxes will be forwarded. Enter the forwarding number (up to 20 digits), and then press **Menu/Set**.

FWD#:  
ENTER & SET KEY

- 4 Press **Stop/Exit**.

### Programming Paging Number

When Paging is selected, your MFC dials the pager number you've programmed, and then dials your Personal Identification Number (PIN); this activates your pager so you know you have a fax message in the memory.

- 1 Press **Menu/Set, 2, 5, 1**.

1.FAX FWD/PAGING

- 2 Press  until the LCD shows **PAGING?**, and then press **Menu/Set**.

- 3 Enter your pager phone number (up to 20 digits) followed by **# #**, and then press **Menu/Set**. Do not include the area code if it is the same as that of your MFC.  
*For example, 1 8 0 0 5 5 5 1 2 3 4 # #.*

PAG#:  
ENTER & SET KEY

- 4 If your pager requires a PIN, enter the PIN, press #, press **Redial/Pause**, enter your MFC telephone number followed by # #, and then press **Menu/Set**.  
For example, **1 2 3 4 5 # Redial/Pause 1 8 0 0 5 2 1 2 8 4 6 # #**  
—OR—

If you do not need a PIN, press **Redial/Pause**, enter the fax number of your MFC followed by # #, and then press **Menu/Set**.

For example, **Redial/Pause 1 8 0 0 5 2 1 2 8 4 6 # #**

- 5 Press **Stop/Exit**.



You cannot change a Paging number or PIN remotely.



Press **Redial/Pause** for each 3.5 second delay, as needed.



## Setting Fax Storage

---

If you set Fax Storage to **ON**, you will be able to retrieve fax messages from another location using Fax Forwarding, Paging, or Remote Retrieval functions. The LCD will indicate when you have a fax stored in memory.

- 1 Press **Menu/Set, 2, 5, 2**. The LCD prompts you to choose a fax setting.

```
2.FAX STORAGE
```

- 2 Press  **or**  to select **ON** (or **OFF**), and then press **Menu/Set**.

- 3 Press **Stop/Exit**.



If there are faxes in memory when you turn the Fax Storage **OFF**, the LCD prompts you to erase any faxes in memory.

```
ERASE ALL FAX?  
1.YES 2.NO
```

If you press **1**, all fax data is erased and Fax Storage is turned off. If you press **2**, data is not erased, and Fax Storage remains on.

(See *Printing a Fax in Memory*, page 5-5.)

## Backup Print

If you have set **FAX STORAGE** to **ON**, your MFC *automatically* prints a faxes as they are received into memory, This is a safety feature in ease the power goes out so you won't lose your message.

# Changing Remote Retrieval Access Code

---

Enter your Remote Access Code when the MFC picks up your call, so you can access features remotely. The access code is preset to 1 5 9 ✳, but you can change this. (See *Operation from Extension Telephone*, page 5-4.)

1 Press **Menu/Set**, **2**, **5**, **3**.

3. REMOTE ACCESS

2 Enter a three-digit number from 000 to 999, and then press **Menu/Set**. The “✳” cannot be changed. (Do not use the same digits that appear in your Fax Receive Code or Telephone Answer Code.)

3 Press **Stop/Exit**.

## Remote Retrieval

---

You can call your MFC from any fax machine using touch tone, then use the Remote Retrieval Access Code and other button presses to retrieve fax messages. *Cut out the Remote Retrieval Access Card on the last page and keep it in your wallet as an aid.*

### Using Remote Retrieval Access Code

1 Dial your fax number from a fax machine using touch tone.

2 When your MFC answers, immediately enter your Remote Retrieval Access Code (1 5 9 ✳).

3 The MFC signals the kinds of messages received:

**1 long beep — Fax message(s)**

**No long beeps — No messages**

4 The MFC then prompts you with two short beeps to enter a command. If you wait longer than 30 seconds to enter a command, the MFC hangs up. If you enter an invalid command, the MFC beeps three times.

5 Press **9 0** to reset the MFC when you're finished.

6 Hang up.



If your MFC is set to **MANUAL** mode, you can access it by waiting about 2 minutes, and then entering the Remote Retrieval Access Code within 30 seconds.

## Remote Commands

Follow the commands below to access features remotely. When you call the MFC and enter your Remote Retrieval Access Code (1 5 9 ✳), the system will signal you with two short beeps to enter a remote command.

Remote Commands	Operation Details
<b>95 Changing Fax Forwarding /Paging setting</b>	
1 OFF	If you hear one long beep, the change is accepted. If you hear three short beeps, you cannot change it because the conditions have not been met (Example: registering paging number). You can register your fax forwarding number by using 4. FAX FWD NO. (see page 9-5). Once you have registered the number, the MFC will change automatically to FAXFWD:ON mode.
2 Fax Forwarding	
3 Paging	
4 FAX FWD No.	
6 Fax Storage ON	You can turn FAX STORAGE to ON or OFF.
7 Fax Storage OFF	
<b>96 Retrieve a fax</b>	
2 Retrieve all faxes	Enter the number of a remote fax machine to receive stored fax messages. (See page 9-5.)
3 Erase faxes from the memory	If you hear one long beep, you can erase fax message(s) from the memory.
<b>97 Check the Receiving Status</b>	
1 FAX	You can check whether your MFC has received any faxes. If yes, you will hear one long beep. If no, you will hear three short beeps.
<b>98 Change the Receive Mode</b>	
1 EXT.TEL/TAD	If you hear one long beep, you can change the Receive Mode. If you hear three short beeps, you cannot change it.
3 FAX ONLY	
<b>90 Exit</b>	After a long beep, you can exit Remote Retrieval.

## Retrieving Fax Messages

- 1 Dial your fax number.
- 2 When you hear the beep, immediately enter your Remote Retrieval Access Code (**1 5 9 \***).
- 3 As soon as you hear two short beeps, use the dial pad to press **9 6 2**.
- 4 Using the dial pad, enter the number of the remote fax machine where you want your fax messages forwarded (up to 20 digits) followed by **# #**.



You cannot use **\*** and **#** as dial numbers. However, if you want to store a pause, press **#**.

- 5 After you hear your MFC beep, hang up and wait.  
Your MFC calls the remote fax machine. The remote fax machine prints your fax messages.

## Changing Fax Forwarding Number

You can change the default setting of your fax forwarding number from a remote telephone/fax machine using touch tone.

- 1 Dial your fax number.
- 2 When you hear the beep, immediately enter your Remote Retrieval Access Code (**1 5 9 \***).
- 3 When you hear two short beeps, use the dial pad to press **9 5 4**.
- 4 Enter the new number of the remote fax machine where you want your fax messages forwarded (up to 20 digits) followed by **# #**.



You cannot use **\*** and **#** as dial numbers. However, if you want to store a pause, press **#**.

- 5 After you hear your MFC beep, hang up.

# 10 Printing Reports

## MFC Settings and Activity

---

Two reports require initial setup in the Menu table: Transmission Verification Report and Activity Report Interval. For initial setup:

Press **Menu/Set, 2, 4, 1**.

1. TRANSMISSION

—OR—

Press **Menu/Set, 2, 4, 2**.

2. ACT. INTERVAL

### Customizing the Transmission Verification Report

You can use the Transmission Report as proof that you sent a fax. This report lists the job number, time and date of transmission and whether the transmission was successful (OK). If you select **ON** or **ON+IMAGE**, the report will print for every fax you send.



When the feature is **OFF**, the report prints only if a transmission *error* prevented delivery (NG).

If you typically send multiple faxes to the same destinations, you may need more than the job numbers to know which faxes you must send again. Selecting **OFF+IMAGE** will print a portion of the fax's first page on the report to help you remember.

1 Press **Menu/Set, 2, 4, 1**.

1. TRANSMISSION

2 Press  to select **OFF**, **OFF+IMAGE**, **ON** or **ON+IMAGE**, and then press **Menu/Set**.

3 Press **Stop/Exit**.

## Setting the Fax Activity Report Interval

You can set the machine to print activity reports at specific intervals (6, 12, 24 hours, 2, 4, or 7 days). If you set the interval to **OFF**, you can print the report by following the Steps in the next page.

- 1 Press **Menu/Set, 2, 4, 2.**

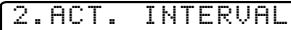

2.ACT. INTERVAL

- 2 Press  to choose an interval, and then press **Menu/Set.**



INTERVAL OFF  
SELECT ↑ ↓ & SET

(If you choose 7 days, the LCD prompts you to choose a day at which to begin the 7-day countdown.)

- 3 Enter the time to begin printing, in 24-hour format, and then press **Menu/Set.** (For example: enter 19:45 for 7:45 PM.)

- 4 Press **Stop/Exit.**

## Using the Reports Key



Five reports are available:

1.HELP LIST

Prints the Menu Table so you can see at-a-glance how to quickly program every menu selection.

2.AUTO DIAL

Lists names and numbers stored in Speed Dial memory, in numerical order.

3.FAX ACTIVITY

Lists information about the last 200 incoming and outgoing faxes. TX means Transmit; RX means Receive.

4.TRANSMISSION

Prints a Transmission Verification Report for your last transmission.

5.USER SETTINGS

Lists settings for **GENERAL SETUP, SETUP RECEIVE, SETUP SEND, PRINT REPORTS,** and **TEL SERVICE.** The settings for **REMOTE FAX OPT** are included.

## To Print a Report

Press **Reports**.

Press  to select the report you want, and then press **Menu/Set**.

—OR—

Enter the number of the report you want to print. For example, press **1** to print the Help List.



# 11 Making Copies

## Using the MFC as a Copier

You can use the MFC as a copy machine, making up to 99 copies at a time.

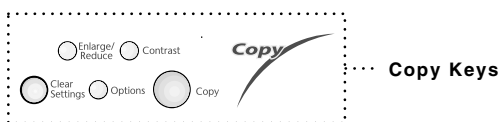

The scannable area of your MFC begins at approximately one-sixth inch (4mm) from the edge of the paper.

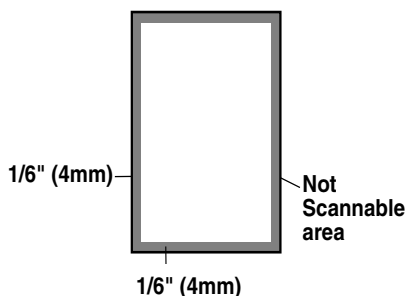

 Incoming faxes cannot be received on paper or into memory while the MFC is copying.

### Making a Single Copy (Using the ADF)

- 1 Place the original face up in the ADF.
- 2 Press **Copy**.  
Do **NOT** pull on the paper while copying is in progress.

 **Note** To stop the copy process and release the original, press **Stop/Exit**.

### Making Multiple Copies (Using the ADF)

- 1 Place the original face up in the ADF.
  - 2 Use the dial pad to enter the number of copies you want (up to 99).
  - 3 Press **Copy**.
-  To sort the copies, use **Options** key. (See *Using the Options Key*, page 11-5.)

## Single or Multiple Copies (Using the Scanner Glass)

If you want to sort multiple copies, use the ADF.

- 1 Lift the Document Cover.

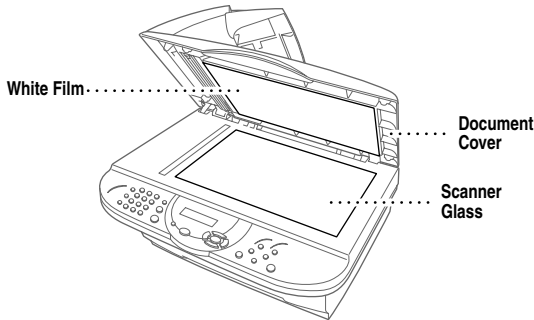

- 2 Using the document guide on the left, center the original *face down* on the scanner glass and close the Document cover.
- 3 Using the dial pad, enter the number of copies you want (up to 99).
- 4 Press **Copy**.

## Out of Memory Message

If the memory becomes full while you are making copies, the LCD shows a message:

OUT OF MEMORY

If the **OUT OF MEMORY** message appears while you are scanning the first page of your original, press **Stop/Exit** to cancel. You will need to clear some faxes from memory before you can continue.



To gain extra memory, you can turn off Fax Storage (see page 9-2).  
—**OR**—Print fax messages in memory (see page 5-5).

# Temporary Copy Settings

You can improve your copies by using the Copy keys: **Enlarge/Reduce**, **Contrast** and **Options**.

These settings are temporary, and the MFC returns to its default settings 45 seconds after it finishes copying. If you want to use these temporary settings again, place the next original in the ADF or on the scanner glass before the 45 seconds expire.



## Copying Using Multiple Settings

You can try different combinations of settings for the best results.

After you finish your settings using the **Enlarge/Reduce**, **Contrast** and **Options** keys, the LCD shows:

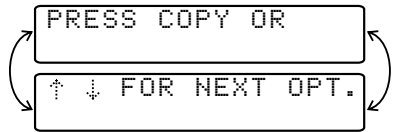

■ Press  if you want to select additional settings.

—OR—

Press **Copy** if you are finished choosing settings.

 To clear your settings and start over, press **Clear Settings**.

 The LCD shows copy settings status. You can set multiple settings.

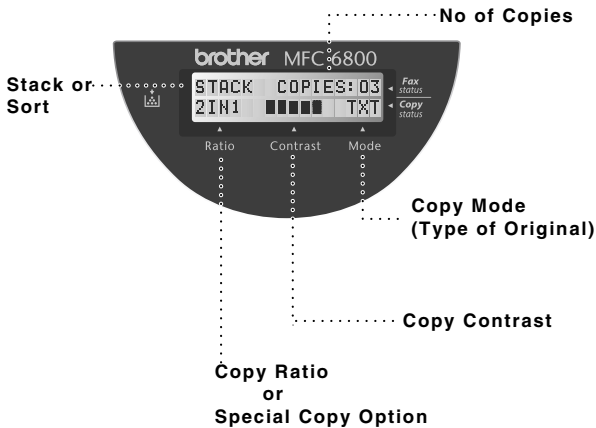

## Using Enlarge/Reduce Key

AUTO sets the MFC to calculate automatically the reduction ratio that fits the size of your paper. **ZOOM** allows you to enter a ratio from 25% to 400% in 1% increments.

Press <b>Enlarge/Reduce</b> and 	ZOOM
	400%
	200%
	150%
	104% EXE>LTR
	100%
	AUTO
	94% A4>LTR
	78% LGL>LTR
	50%
	25%

- 1 Place the original face up in the ADF, or on the scanner glass.
- 2 Use the dial pad to enter the number of copies you want (up to 99).
- 3 Press **Enlarge/Reduce** (Enlargement or reduction ratios appear).
- 4 Press  to select **25%**, **50%**, **78%**, **94%**, **100%**, **AUTO**, **104%**, **150%**, **200%**, **400%**, and then press **Menu/Set**.

—OR—

For more choices select **ZOOM**, use the dial pad to enter any percentage between **25%** and **400%**, and then press **Menu/Set**.

- 5 Press **Copy** —OR— Press  for additional settings.



Special Copy Options (2in1, 4in1 or Poster copy) are *not* available with **Enlarge/Reduce**.

When selecting an enlargement or reduction ratio, you need to know the size of the paper you registered in Menu 1-1.



### Selecting a Fixed Ratio:

Original is the size of...	Paper size is...	Recommended ratio is...
LEGAL	LETTER	78%
A4	LETTER	94%
EXECUTIVE	LETTER	104%

## Copy Contrast

You can adjust copy contrast to make copies darker or lighter.

- 1 Place the original face up in the ADF, or face down on the scanner glass.
- 2 Use the dial pad to enter the number of copies you want (up to 99).
- 3 Press **Contrast**.

- 4 Press  to make a copy lighter, or  to make a copy darker, and then press **Menu/Set**.



- 5 Press **Copy—OR—**Press  for additional settings.



## Using the Options Key

Use the **Options** key to set the resolution (**COPY MODE**), **SORT** or special copy options. See the explanations below the table.



Press Options	Menu Selections	Options	Factory Setting
 Options	OPT:# OF COPIES	NO. OF COPIES:XX	01
	OPT:COPY MODE	AUTO/TEXT/PHOTO	AUTO
	OPT:STACK/SORT	STACK/SORT	STACK
	OPT:SPECIAL	2IN1/4IN1/POSTER/OFF	OFF
	OPT:PAPER TYPE	THIN/PLAIN/THICK/ THICKER/TRANSPARENCY	PLAIN

## Copy Mode (Type of Original)

You can select the Copy resolution for your type of original. The default setting is **AUTO**, which is used for originals that contain both text and photographs. **TEXT** is used for originals containing only text. **PHOTO** is used for copying photographs.



- 1 Place the original face up in the ADF, or face down on the scanner glass.
- 2 Use the dial pad to enter the number of copies you want (up to 99).
- 3 Press **Options** and  to select **OPT:COPY MODE** and then press **Menu/Set**.
- 4 Press  to choose the type of original (**AUTO**, **TEXT** or **PHOTO**), and then press **Menu/Set**.
- 5 Press **Copy—OR—**Press  for additional settings.

## Sorting Multiple Copies (Using the ADF)

- 1 Place the original face up in the ADF.
- 2 Use the dial pad to enter the number of copies you want (up to 99).
- 3 Press **Options** and  to select **OPT:STACK/SORT**, and then press **Menu/Set**.
- 4 Press  to select **SORT**, and then press **Menu/Set**.
- 5 Press **Copy**—OR—Press  for additional settings.



## Special Copy Options (Using the ADF)

You can save paper by copying either two or four pages onto one page.

- 1 Place the originals face up in the ADF.
- 2 Use the dial pad to enter the number of copies you want.
- 3 Press **Options** and  to select **OPT:SPECIAL**, and then press **Menu/Set**.
- 4 Press  to select **2 IN 1**, **4 IN 1** or **OFF**, and then press **Menu/Set**.
- 5 Press **Copy**—OR—Press  for additional settings.

## Special Copy Options (Using the Scanner Glass)

You can save paper by copying either two or four pages onto one page, or you can create poster size copy.

- 1 Place the original face down on the scanner glass.
- 2 Use the dial pad to enter the number of copies you want.
- 3 Press **Options** and  to select **OPT:SPECIAL**, and then press **Menu/Set**.
- 4 Press  to select **2 IN 1**, **4 IN 1**, **POSTER** or **OFF**, and then press **Menu/Set**.
- 5 Press **Copy**.



If you selected **2 IN 1** or **4 IN 1** in step 4, place the next original on the scanner glass, and then press **Menu/Set**. After all originals have been scanned, press **Copy**.

NEXT:PRESS SET
END:PRESS COPY

## 2 in 1

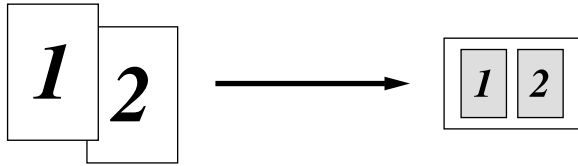

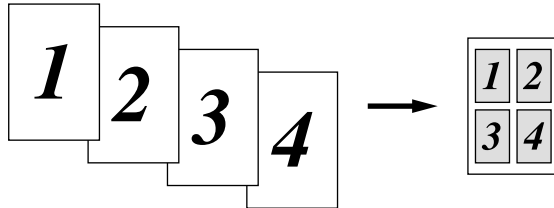

## 4 in 1

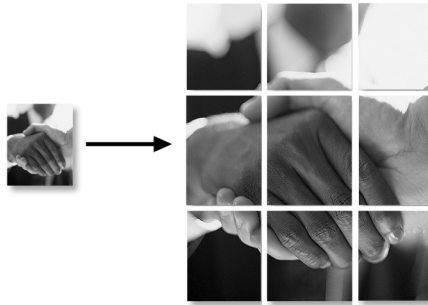

## Poster

You can create a poster size copy of a photograph.





 Special Copy Options (2in1, 4in1 or Poster) are not available with **Enlarge/Reduce**.

 Poster is not available for multiple copies and requires using the scanner glass.

## Paper Type

You can use the following types of paper for copying. For the best print quality, select the type of media that you are using.

- THIN** (17lb - 18.4lb) - For thin paper
- PLAIN** (18.7lb - 25.3lb) - For ordinary plain paper
- THICK** (25.6lb - 32lb) - For heavy weight paper or rough paper
- THICKER** (32.3lb - 42.1lb) - For heavier weight paper, rough paper or bond paper.
- TRANSPARENCY** - For transparency (OHP)

- 1 Press **Options** and  to select **OPT:PAPER TYPE**, and then press **Menu/Set**.
- 2 Press  to select your type of paper, and then press **Menu/Set**.
- 3 Press **Copy**—OR—Press  for additional settings.

## Changing Default Copy Settings

Press **Menu/Set**, **3** to change default settings for Copy mode. These settings will remain until you change them again by pressing **Menu/Set**. Adjust the Contrast and Quality settings.

By pressing a number, you can adjust copy settings as shown in the following chart. Press  to scroll through the options for each setting. Press **Menu/Set**

to save your selection. Press **Stop/Exit**—OR—Press  to select the next setting you want to change.

Press **Menu/Set**, and **3**.

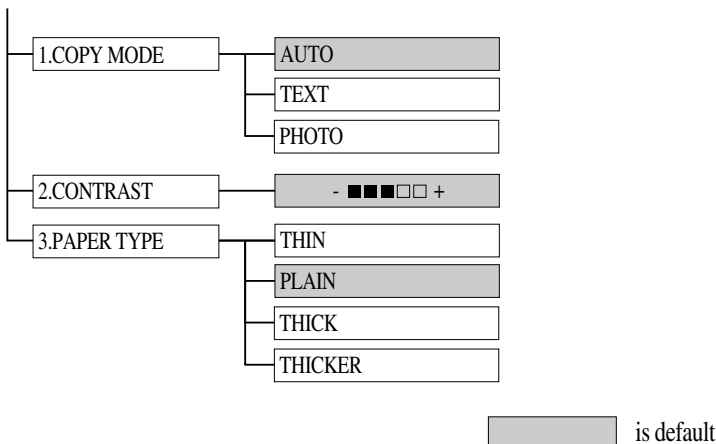



## Copy Mode (Type of Original)

You can select the Copy resolution for your type of original. The default setting is **AUTO**, which is used for originals that contain both text and photographs. **TEXT** is used for originals containing only text. **PHOTO** is used for copying photographs.

- 1 Press **Menu/Set, 3, 1.**

1. COPY MODE



- 2 Press  to choose the type of original (**AUTO**, **TEXT** or **PHOTO**), and then press **Menu/Set.**
- 3 Press **Stop/Exit.**

## Copy Contrast

You can adjust copy contrast to make copies darker or lighter.

- 1 Press **Menu/Set, 3, 2.**

2. CONTRAST

- 2 Press  to make a copy lighter —**OR**— Press  to make a copy darker, and then press **Menu/Set.**
- 3 Press **Stop/Exit.**

## Paper Type

You can use the following types of paper for copying. For the best print quality, select the type of media that you use most often.

- |                                  |  |
|----------------------------------|--|
| <b>THIN</b> (17lb - 18.4lb)      | - For thin paper                                       |
| <b>PLAIN</b> (18.7lb - 25.3lb)   | - For ordinary plain paper                             |
| <b>THICK</b> (25.6lb - 32lb)     | - For heavy weight paper or rough paper                |
| <b>THICKER</b> (32.3lb - 42.1lb) | - For heavier weight paper, rough paper or bond paper. |

- 1 Press **Menu/Set, 3, 3.**
- 2 Press  to select your type of paper, and then press **Menu/Set.**
- 3 Press **Stop/Exit.**

# 12 Using Brother Machine as a Printer

## ***Special Printing Features***

---

### **Windows® Printing**

The dedicated printer driver and TrueType™ compatible fonts for Microsoft® Windows® 95/98 and Windows NT® Workstation Version 4.0 are available on the CD-ROM supplied with your machine. You can install them easily into your Windows® system using our installer program. The driver supports our unique compression mode to enhance printing speed in Windows® applications; it allows you to set various printer settings, including economy printing mode and custom paper size.

### **Bi-directional Parallel Interface**

The Brother machine's parallel interface enables it to send memory and printer setup information to the computer.

## ***Printing from Your PC***

---

### **Multi-purpose Sheet Feeder**

The MFC's multi-purpose sheet feeder can feed plain paper, envelopes, and organizer paper. When the MFC receives data from your computer, it begins the print process by loading paper from the multi-purpose sheet feeder.

- Select the print command from your PC.

Your PC sends a print command and data to the MFC. If there are more pages, the MFC begins to print the next page automatically.



You may select the paper source, paper size, and orientation in your application software.

If your application software does not support your custom paper size, select the next larger paper size. Then adjust the print area by changing the left and right margins in your application software. (See *Acceptable Paper*, page 2-7.)

## Two-Sided Printing (Manual Duplex)

The supplied printer drivers for Windows® 95/98/98SE, Windows NT® Workstation Version 4.0 support manual duplex printing. (For more information, see the Help screen for the printer driver.)

Please select LPT1 port in the printer driver. The MFC prints all the even-numbered pages on one side of the paper first. Then, the Windows® driver instructs you (with a pop-up message) to reinsert the paper. Before reinserting the paper, straighten it well or you may get a paper jam. Very thin or very thick paper is not recommended. If the paper “double-feeds” (sends two sheets at once), hold the stack of paper except for the front sheet while the paper is feeding.

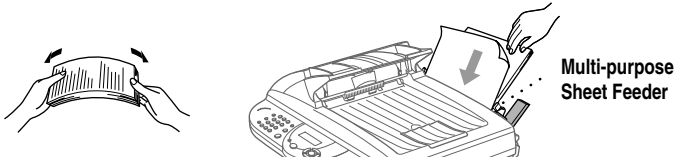

! When you use manual duplexing, it is possible that a paper jam may occur or the printer quality might not be satisfactory.

## Loading Envelopes in Multi-purpose Sheet Feeder

You can load up to 10 envelopes into the multi-purpose sheet feeder. Press down and hold the blue lever on the right as you load the envelopes and slide the paper guides to fit. Make sure envelopes are inserted in the direction shown below.

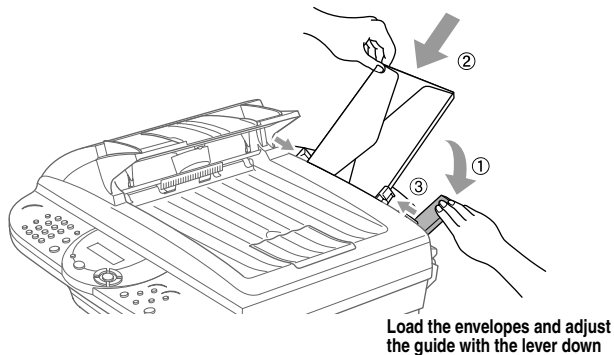

## Paper Tray

The MFC ejects paper with printed surfaces *face down* into the paper tray at the front of the machine. When you use transparencies, remove each sheet immediately after printing, to prevent a paper jam or curled sheets.

## ***Simultaneous Printing/Faxing***

---

Your MFC can print data from your computer while sending or receiving a fax, or while scanning information into the computer. However, when the MFC is copying or receiving a fax on paper, it pauses the PC printing operation and then resumes when copying or fax receiving is complete. Fax sending continues during PC printing.

## ***Choosing Acceptable Paper***

---

We recommend that you test paper, especially special sizes and types, on the MFC before purchasing large quantities. See *Acceptable Paper*, page 2-7

- Avoid feeding labels with carrier sheets exposed, or your MFC will be damaged.
- Avoid using coated paper, such as vinyl coated paper.
- Avoid using preprinted or highly textured paper.
- For optimum printing use a recommended type of paper, especially plain paper and transparencies. For more information on paper specifications, consult your nearest authorized sales representative or the place where you purchased your MFC.
- Use labels or transparencies that are designed for use in laser printers.
- For the best print quality we recommend that you use long-grained paper.
- If you are using special paper that has problems feeding from the multi-purpose sheet feeder, try again using the manual feed slot.
- You can use recycled paper in this MFC.

## ***Printer Operations***

---

### **Reset Key**

Press this key to clear data from the memory.

# 13 Printer Driver Settings (For Windows® Only)

## ***Using the Brother MFC-6800 Printer Driver***

---

A Printer Driver is software that translates data from the format used by a computer into the format required by a particular printer, using a printer command language or page description language.

The printer drivers are on the supplied CD-ROM. The latest printer driver can also be downloaded from the Brother Solutions Center at

<http://solutions.brother.com>

### **Features in the PCL Printer Driver (For Windows® Users Only)**



The screens shown in this section are from Windows® 98. The screens on your PC may vary depending on your Windows® Operating System.

For more detailed information, please see the on-line Help in the printer driver.

# Basic Tab

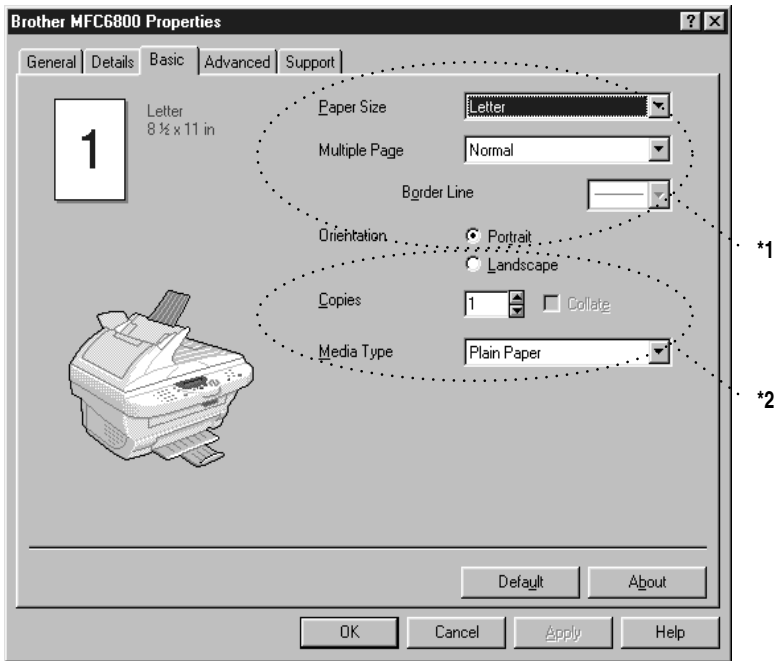

\*1 Select the Paper size, Multiple Page and Orientation.

\*2 Select number of Copies and Media Type.

## Paper Size

From the drop-down box select the Paper Size you are using.

## Multiple Page

The Multiple Page selection can reduce the image size of a page allowing multiple pages to be printed on one sheet of paper or enlarging the image size for printing on page on multiple sheets of paper.

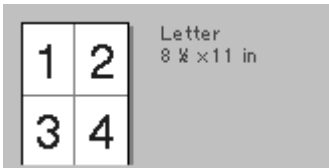

**Ex. 4 in 1**



**Ex. 1 in 2 x 2 pages**

## Border Line

When printing multiple pages on one sheet with the Multiple Page feature you can select to have a solid border, dash border or no border around each page on the sheet.

## Orientation

Orientation selects the position of how your document will be printed (Portrait or Landscape).

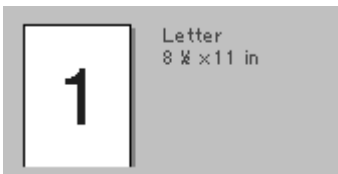

**Portrait**

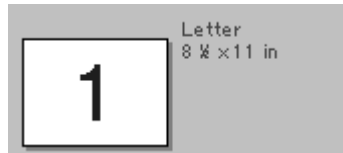

**Landscape**

## Copies

The copies selection sets the number of copies that will be printed.



## Collate

The collate selection is active if more than one copy is selected. With the collate check box selected, one complete copy of your document will be printed and then repeated for the number of copies you selected. If the collate check box is not selected then each page will be printed for all the copies selected before the next page in the document is printed.

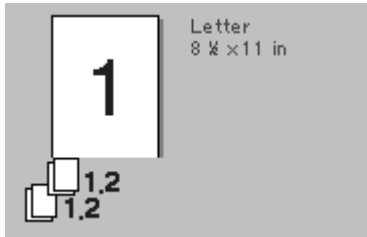

Collate box checked

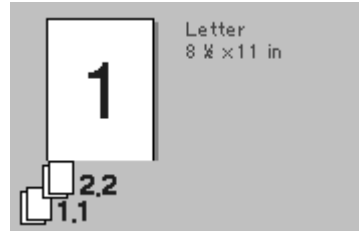

Collate box not checked

## Media Type

You can use the following types of media in your printer. For the best print quality, select the type of media that you wish to use.

**Plain Paper**

**Thin Paper**

**Thick Paper**

**Thicker Paper**

**Bond Paper**

**Transparencies**

When using ordinary plain paper, select **Plain Paper**. When using heavier weight paper, envelopes or rough paper select **Thick Paper** or **Thicker Paper**. For bond paper, select **Bond Paper** and for OHP transparencies, select **Transparencies**.

# Advanced Tab

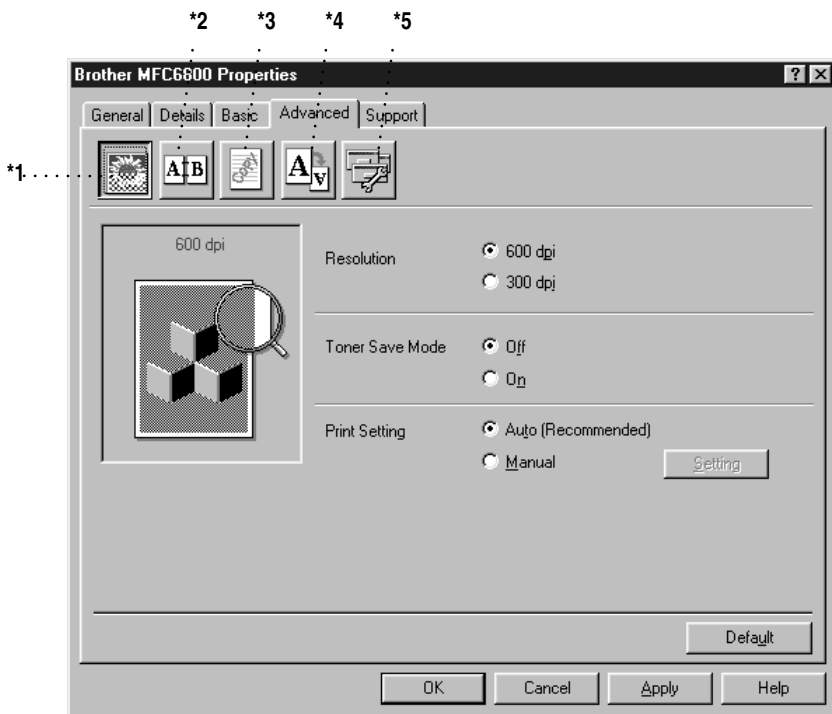

Change the tab settings by selecting one of the following icons:

- \*1 Print Quality
- \*2 Duplex Printing
- \*3 Watermark
- \*4 Page Setting
- \*5 Device Option

## Print Quality (\*1)

### Resolution

You can change the resolution as follows:

- 300 dpi
- 600 dpi

### Toner Save

You can save running costs by turning on the Toner Save Mode, which reduces the print density.

## Print Setting (For Windows® 95/98/98SE/Me Users Only)

Print Setting is used for optimizing your print quality for the type of document being printed (Photos, Graphics or Scanned Images). When you choose **Auto (Recommended)**, the printer automatically prints with the most suitable print settings.

With the Print Setting set to Manual, you can change the Brightness, Contrast and Graphics Quality options manually.

## Duplex Printing (\*2)

Choosing the Duplex Printing icon displays the Manual Duplex features available.

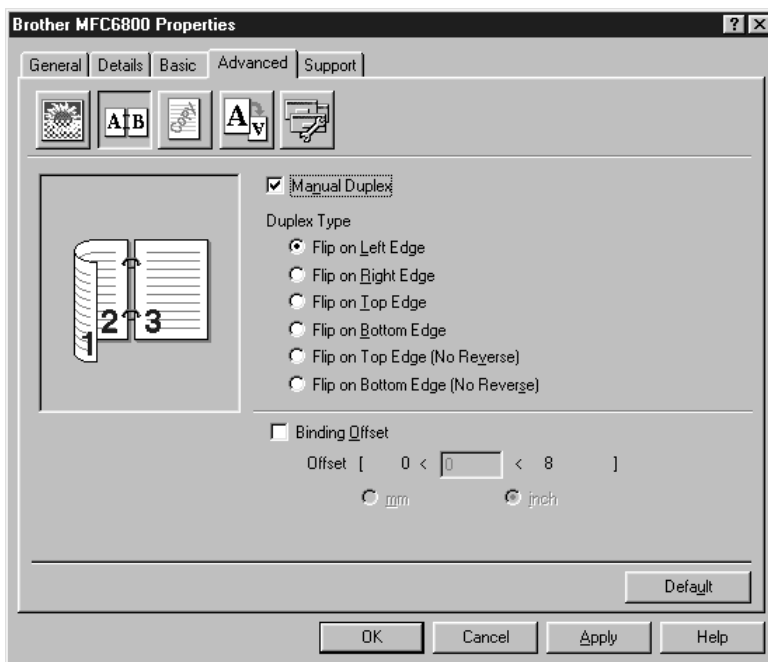

### Manual Duplex

Check the Manual Duplex box and there are six types of duplex directions available for each orientation. In this mode, the MFC prints all the even numbered pages first. Then the printer driver stops and shows the instructions required to re-install the paper. When you click OK the odd numbered pages are printed.

### Binding Offset

Check the Binding Offset option, you can specify the offset value of the binding side in inches or millimeters (0 - 8 inches) [0 - 203.2 mm].

## Watermark (\*3)

You can place a logo or text into your document as a Watermark by using a bitmap file as your source file or select one of the preset Watermarks.

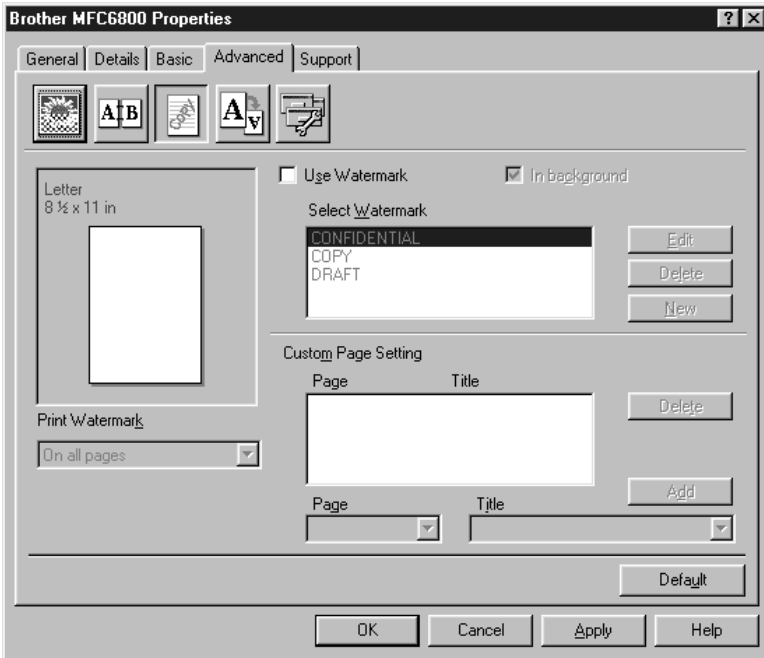

### Print Watermark

The Print Watermark feature offers printing choices of:

**On all pages**

**On first page only**

**From second page**

**Custom**

### In background

With the In background feature checked the Watermark will print behind your document on the page. If this feature is not checked then the Watermark will print on top of your document.

You can change the size and the position of the Watermark on the page by selecting the Watermark and clicking the Edit button. If you want to add a new Watermark, click the New button and select Text or Bitmap from the Watermark Style.

## Watermark Text

Enter your Watermark text into the Text Box and select the Font, Size, Darkness and Style.

## Watermark Bitmap

Enter the file name and location of your bitmap image in the File box or Browse for the file location. You can also set the scaling size of the image.

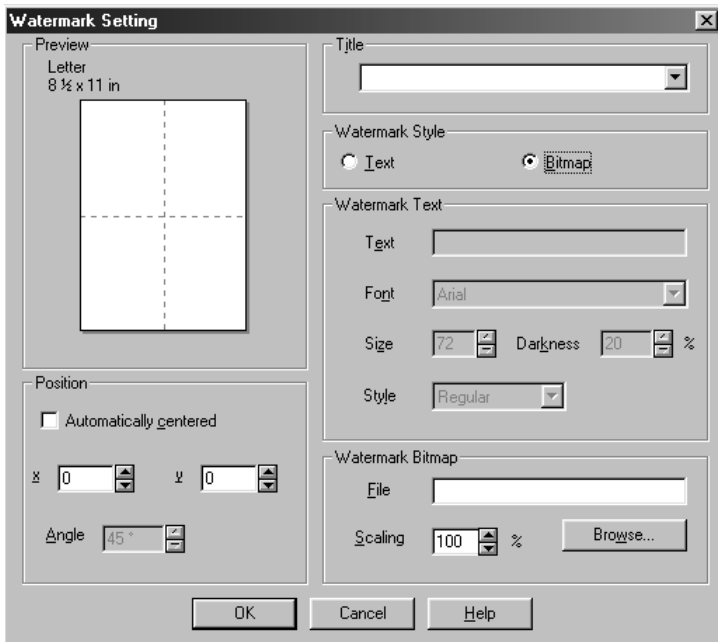

## Position

The position settings offer controls on where the Watermark can be positioned on the page.

## Page Setting (\*4)

You can change the print size of your document with the Scaling feature.

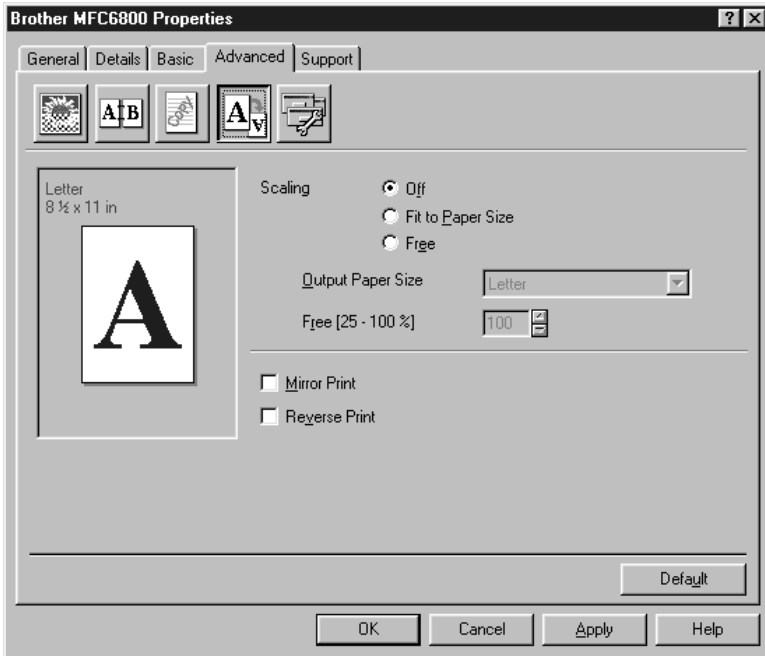

- 1 Check Off if you want to print the document as it appears on your screen.
- 2 Check Fit to Paper Size, if your document has an unusual size, or if you have only the standard size paper.
- 3 Check the Free box if you want to reduce or enlarge the output.

You can also use the Mirror or Reverse Print feature for your page setting.

## Device Options (\*5)

Set one of the following Printer Functions:

- Quick Print Setup
- Administrator (For Windows® 95/98/98SE/Me Users Only)
- Print Date & Time

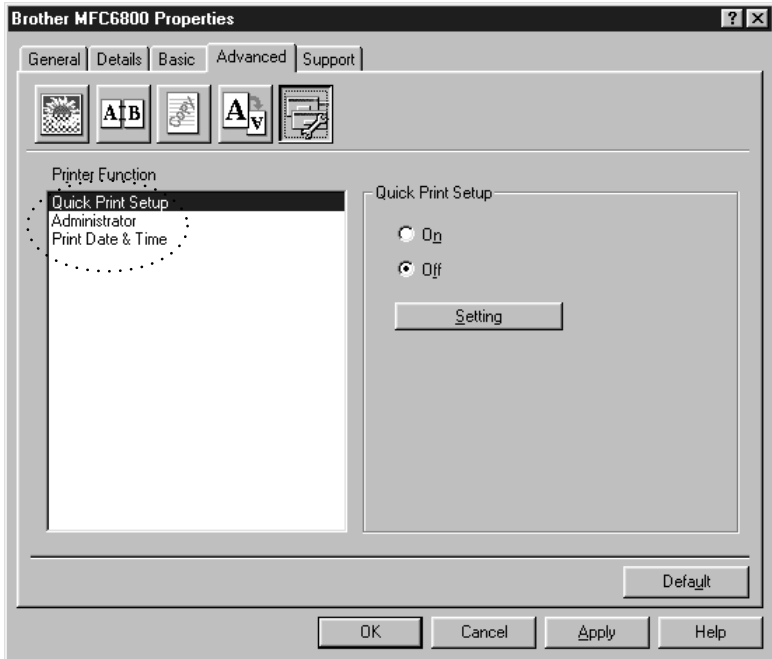

## Quick Print Setup

The Quick Print Setup feature allows you to quickly select driver settings. To view settings, simply click your mouse button on the task tray  icon. This feature can be set to ON or OFF from the Device Options section.

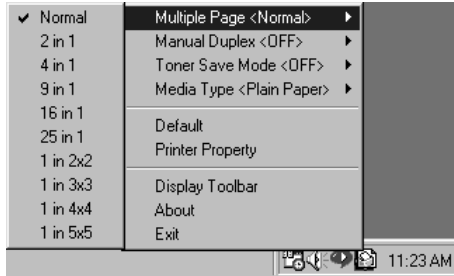

## Administrator (For Windows® 95/98/98SE/Me Users Only)

The administrator selection permits the Copy, Scaling and Watermark features to be locked and password protected.

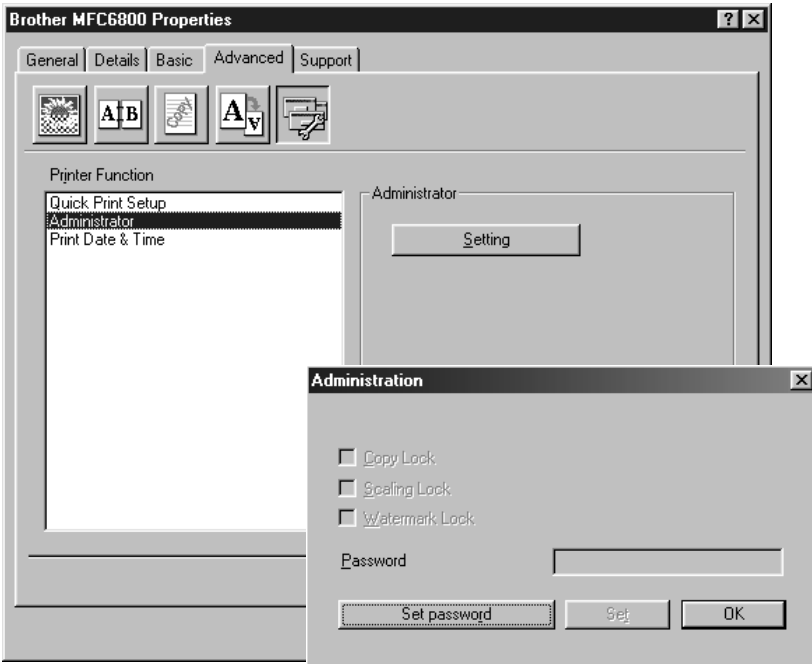

**Note** Record your password and keep it in a safe place for future reference. If you forget your password these settings can not be accessed.



## Print Date & Time

When enabled the Print Date and Time feature will automatically print the date and time on your document from your computer's system clock.

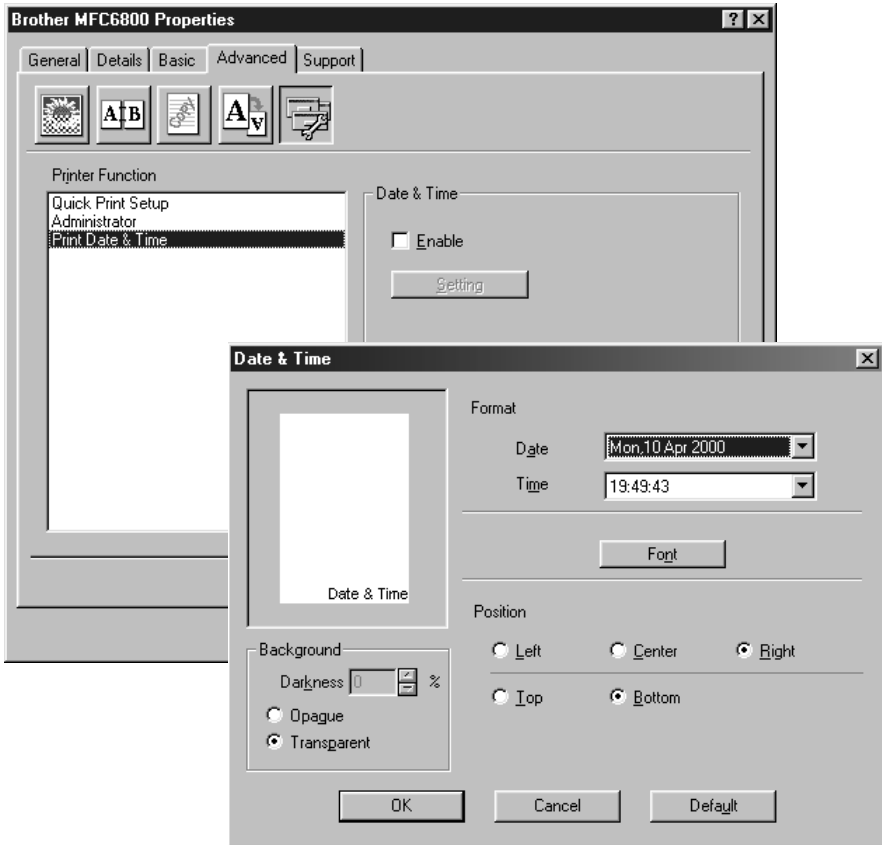

Click the Setting button to change the Date and Time Format, Position and Font. To include a background with the Date and Time select Opaque. When Opaque is selected you can set the Darkness of the Date and Time background by changing the percentage.



The Date and Time indicated in the selection box represents the format that will be printed. The actual Date and Time printed on your document is automatically retrieved from the settings of your computer.

# Support

The Support Tab provides driver version information and setting information. In addition there are links to the Brother Solution Center and Driver Update Web sites.

## Brother Solutions Center

The Brother Solutions Center is a Web site offering information about your Brother product including FAQ's , User Guides, Driver updates and Tips for using your machine.

## Web Update

Web Update checks the brother web site for updated driver and automatically downloads and updates the driver on your computer.

## Check Setting

The Check Setting selection displays a list of your current drivers settings.

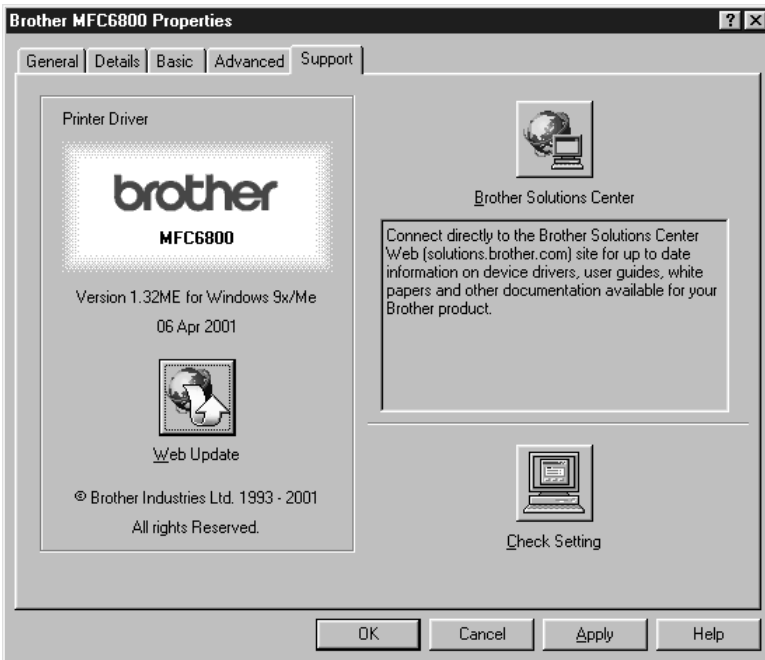

# Features in the Printer Driver (For Windows® 2000)

 The Windows® 2000 printer driver utilizes Microsoft's uni-driver architecture. The following section describes the driver features and selections available for Windows® 2000.

## General Tab

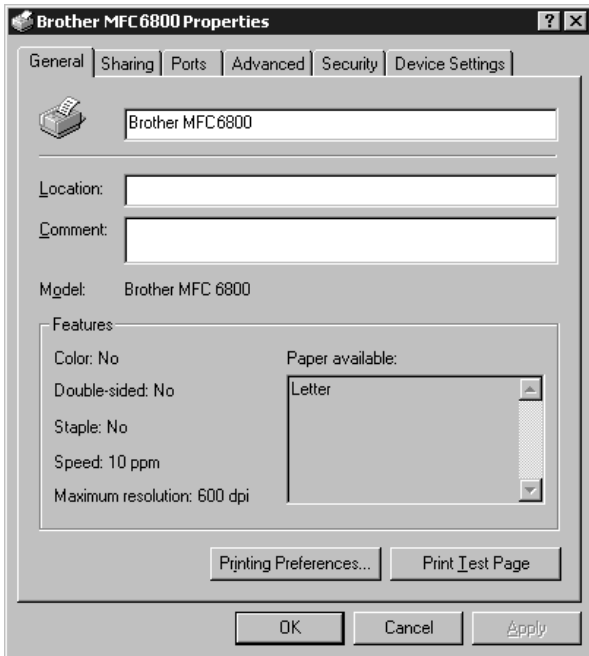

## Printing Preferences

In the General tab, click the **Printing Preferences...** button to access the Layout tab.

# Layout Tab

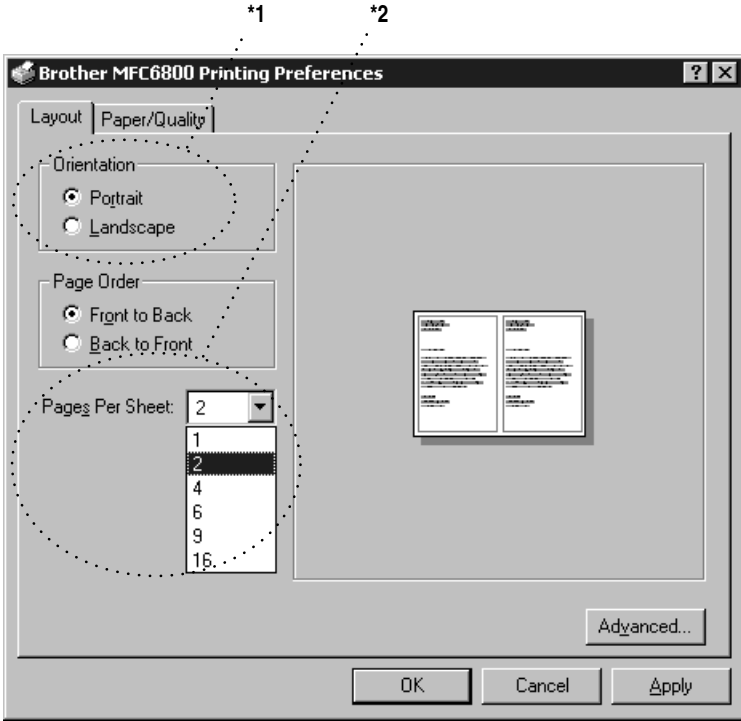

## \*1 Orientation

Select the Orientation, which is how your document will be positioned on the paper (Portrait or Landscape).

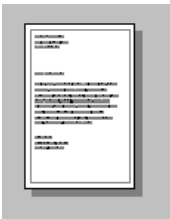

Portrait

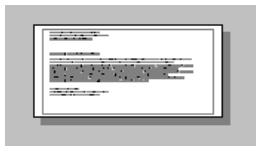

Landscape

## \*2 Pages Per Sheet

You can select 1, 2, 4, 6, 9 or 16 pages to be printed on one sheet of paper. The image of each page will be reduced as needed to fit on the paper.

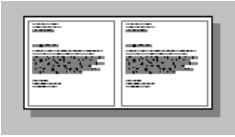

2 in 1

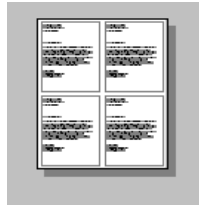

4 in 1

## Paper/Quality Tab

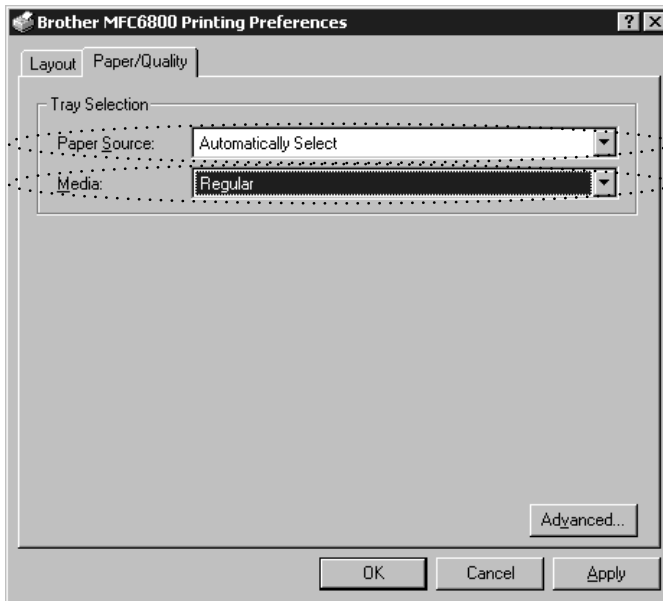

### \*1 Paper Source

The paper source is set to “Automatically Select” because the FAX will select the appropriate paper source for you.

## \*2 Media

For the best print quality, select the type of media you are using:

- Regular
- Thick Paper
- Thicker Paper
- Transparency

When using ordinary plain paper, select Regular. When using heavier weight paper, envelopes, or rough paper, select Thick Paper or Thicker Paper. For OHP transparencies, select Transparency.

## Advanced Options

Click the **Advanced...** button in the Paper/Quality tab to access the screen below:

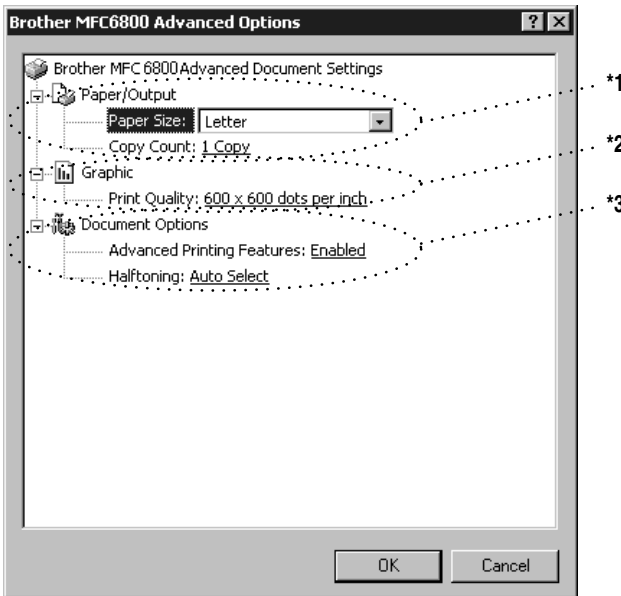

### \*1 Paper /Output

*Paper Size* – Select the paper size of the document you are printing. This size should be the same as the paper size that is set in your application software.

*Copy Count* – Type the number of copies you want.

## **\*2 Graphic**

*Print Quality* – You can change the resolution as follows:

- 600 × 600 dots per inch
- 300 × 300 dots per inch

## **\*3 Document Options**

*Advanced Printing Features* – You can Enable or Disable Advanced Printing Features from this selection. If you disable it, Page Order, Pages Per Sheet, Copy and Collate will be disabled.

*Halftoning* – This selection is for changing the dither pattern to achieve the best print results when printing graphics. The choices are as follows:

- Auto Select
- Super Cell
- Dither 6 × 6
- Dither 8 × 8

## Device Settings Tab (Not Available)



*Form To Tray Assignment* – The paper size is displayed. If you want to change the paper size, click the **Advanced** button in the Paper/Quality tab, and then select another paper size.



# 14 Using the Windows®-Based Brother MFL-Pro Control Center (For Windows® Only)

## Brother MFL Pro Control Center

The Brother Control Center is a software utility that pops up on the PC screen whenever paper is placed in the automatic document feeder (not on the scanner glass). This allows you to quite easily, with very few mouse clicks, access the most frequently used scanning applications. Using the Control Center eliminates the need to manually launch the specific applications.

The Brother Control Center provides three categories of operations:

- 1 Scan directly to a file, E-mail, word processor or graphic application of choice
- 2 Copy operations
- 3 PC Faxing using the Brother MFL Pro PC Fax software

MFC-6800



## AutoLoad the Brother Control Center

The Control Center is initially configured to automatically load each time Windows® is started. When the Control Center is loaded, the Control



Center  icon will appear in the task bar. If you don't want the Control Center to load automatically, you can turn off AutoLoad.



If the Control Center  icon does not appear in your task bar, you will have to launch this software.

From the **Start** menu, select **Programs**, **PaperPort**, and then double-click **Brother SmartUI POPUP**.

## How to Turn Off AutoLoad

- 1 Left click the Control Center  icon and click **Show**.
- 2 When the Control Center icon appears, left click on the Smart Click  Control Center button. A dialogue box with a check box labeled “AutoLoad Pop-up” will appear:

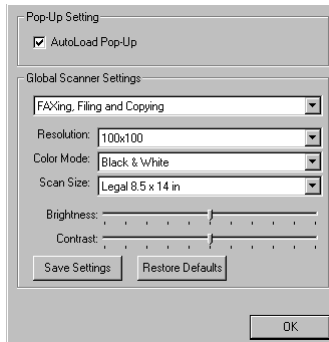

- 3 Uncheck the AutoLoad Pop-Up option.

## Using the Scan Key

You can use the Scan key on the control panel to scan originals into your word processing, graphics or E-mail applications.

The advantage of using the **Scan to** key is that you avoid the mouse clicks required to scan from your PC.

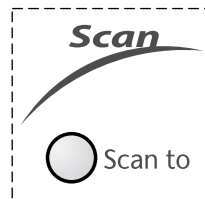

## Using the Control Panel Keys

-  If you have connected a Macintosh, the control panel keys will not work with your computer. Please see page 18-1.

Before you can use the **Scan to** key on the control panel, you must have connected the MFC to your Windows®-based PC and loaded the appropriate Brother Drivers for your version of Windows®. When you are ready to use the Scan key, make sure the Brother Control Center application is running on your PC.

## Scan Image

You can scan a color picture into your graphics application for viewing and editing.

- 1 Place the original face up in the ADF.
- 2 Press **Scan to**.
- 3 Press  to select **SCAN IMAGE**, and then press **Menu/Set**.

The MFC will scan the original and send an image to your graphics application.

## Scan/OCR

If your original is text, you can have it automatically converted by ScanSoft™ TextBridge® to an editable text file and then displayed in your word processing application for further editing.

- 1 Place the original face up in the ADF.
- 2 Press **Scan to**.
- 3 Press  to select **SCAN/OCR**, and then press **Menu/Set**.

The MFC will scan the original, perform OCR in ScanSoft™ TextBridge®, and then display the result in your word processing application for viewing and editing.

## Scan to E-mail

You can scan an color original into your E-mail application as a file attachment. Although the Brother Control Center can be configured to send file attachments at one time, you can easily change this setting.

- 1 Place the original face up in the ADF.
- 2 Press **Scan to**.
- 3 Press  to select **SCAN TO E-MAIL**, and then press **Menu/Set**.

The MFC will scan the original, create a file attachment, and launch your E-mail application, displaying the new message waiting to be addressed.



# Brother Control Center Features

---

## Auto Configuration

During the installation process the Control Center checks your system to determine the default applications for E-mail, word processing and graphics viewer/editor. For example, if you are using Outlook as your default E-mail application, the Control Center automatically will create a link and a scanning application button for Outlook.

You can change a default application by right clicking on any of the scan buttons in the Control Center and selecting a different application. For example,

you can change a scan button from MS Word  to MS Word Pad  by changing the application that is listed for the Word Processor.



## Scanning Operations

*Scan to File*—allows you to scan directly to a disk file with two mouse clicks. You can change the file type, destination directory and file name, as needed.

*Scan to E-mail*—enables you, with just two mouse clicks, to scan a picture or text document directly into an E-mail application as a standard attachment. You have the option of selecting the file type and resolution for the attachment.

*Scan to Word Processor*—enables you to scan a text document, run ScanSoft TextBridge OCR and insert the text original (not graphic image) into a word processing file with just two mouse clicks. You have the option of selecting the destination word processing program, such as Word Pad, MS Word, Word Perfect, etc.

*Scan to Graphic Application*—allows you to scan an image directly into any graphic viewer/editor application. You can select the destination application, such as MS Paint or Corel PhotoPaint.

## Copy Operations

*Copy*—allows you to use the PC and any Windows® printer driver for enhanced copy functions. You can scan the page on the Brother MFC and print the copies using any of the features of the Brother MFC printer driver—**OR**—you can direct the copy output to any standard Windows® printer driver installed on the PC.

## PC Fax Operation

*Send a Fax*—allows you to scan a picture or text original and automatically send the image as a fax from the PC using the Brother MFL Pro fax software.

## Scanner Settings for Scan, Copy and PC Fax Buttons

When the Pop-Up window appears, you can access the Scanner Settings window.

Click the Smart Click  icon at the top right of the Brother Control Center screen—**OR**—Click the **Modify Settings...** button on any of the Configuration screens.

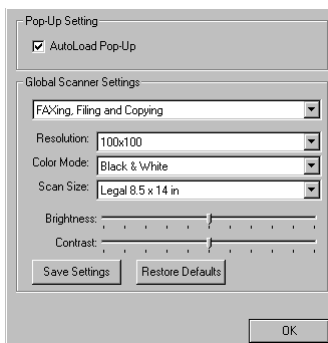

## Global Settings

*AutoLoad Pop-Up*—Click this checkbox if you want Brother MFL Control Center to load when you boot your computer.

## Setting Up the Scanner Configurations

The Pop-Up application stores eight different scanning modes. Each time you scan an original, you will choose the most appropriate scanning mode from the following:

*Faxing, Filing and Copying*

*Text for OCR*

*Photos*

*Photos (High Quality)*

*Photos (Quick Scan)*

*Custom*

*Draft Copy*

*Fine Copy*

Each mode has its own set of stored settings. You can keep the factory default settings or change them at any time:

*Resolution*—Select the scanning resolution you most frequently use.

*Color Mode*—From the pull-down list, select

*Scan Size*—From the pull-down list, select

*Brightness*—Slide the adjuster from 0% to 100%

*Contrast*—Slide the adjuster from 0% to 100%

Click **OK** to save your changes. If you make a mistake or later decide to return to the original default setting, just click the **Restore Defaults** button when the scanning mode is displayed.

## To Access the Scanner Configurations Screen

- 1 Place the original face up in the ADF. Then the Brother Control Center screen pops up.
- 2 Right-click the appropriate Control Center button to display *Configurations...*, then click it. The configuration screen for that **Control Center** button will appear.
- 3 To save your settings, press the **OK** button—**OR**—To return to the factory default settings, press the **Restore Defaults** button.



You can not access the Scanner Configuration screen by placing the document on the scanner glass.

## Perform an Operation from the Control Center Screen

If you see this screen it means you left-clicked a button in the Control Center window without first placing an original in the ADF.

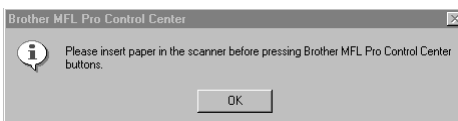

Place the original in the Brother machine's ADF, then click **OK** to return to the Control Center screen.



If you want to scan the document from the scanner glass, please use **Scan to** key on the control panel. (See *Using the Control Panel Keys*, page 14-2.)

## Scan to File

---

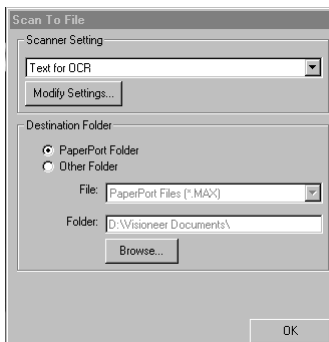

## Scanner Settings

From the pull-down list, select the scanning mode that is appropriate for the type of file: Faxing, Filing and Copying; Text for OCR; Photos; Photos (High Quality); Photos (Quick Scan); Custom; Draft Copy or Fine Copy.

To change any of the settings for that mode, click the **Modify Settings...** button.

## Destination Folder

*PaperPort Folder*—Select this checkbox to scan the original into your PaperPort folder.

*Other Folder*—Select this checkbox, to scan the original as another file type and/or into another directory/folder.

*File*—If you selected Other Folder, from the pull-down list select the type of file:

- PaperPort Files (\*.MAX)
- Self Viewing Files (\*.EXE)
- PaperPort 5.0 Files (\*.MAX)
- PaperPort 4.0 Files (\*.MAX)
- PaperPort 3.0 Files (\*.MAX)
- Windows Bitmap (\*.BMP)
- PC Paintbrush (\*.PCX)
- Multi-page PCX (\*.DCX)
- JPEG Image Files (\*.JPG)
- TIFF-Uncompressed (\*.TIF)
- TIFF Group 4 (\*.TIF)
- TIFF Class F (\*.TIF)
- Multi-Page TIFF-Uncompressed (\*.TIF)
- Multi-Page TIFF Group 4 (\*.TIF)
- Multi-Page TIFF Class F (\*.TIF)
- PDF Files (\*.PDF)
- Portable Network Graphics (\*.PNG)
- FlashPix (\*.FPX)
- HFX Fax Files (\*.HFX)

To Search your system for the directory and folder you want, click the **Browse...** button. Click **OK** to save your settings.

## Scan to E-mail

---

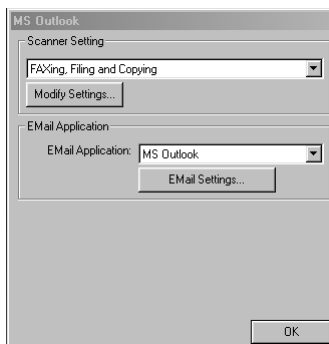



## Scanner Settings

From the pull-down list, select the scanning mode that is appropriate for the type of file: Faxing, Filing and Copying; Text for OCR; Photos; Photos (High Quality); Photos (Quick Scan); Custom; Draft Copy or Fine Copy.

To change any of the settings for that mode, click the **Modify Settings...** button.

## E-mail Application

*E-mail Application*—From the pull-down list, select your E-mail application.

*E-mail Settings*—Click the **EMail Settings...** button to set up links.

The Links Preferences window will appear:



## File Attachments

*Do not convert files*—Click this checkbox if you do not want to change the file type of attachments. The Conversion Options will not be available (grayed).

*Convert MAX files only*—Click this checkbox if you want to convert only attachments that are PaperPort files.

*Convert all files when possible*—Click this checkbox if you want to change the file type of all attachments.

## Conversion Options

### Format

*Combine all files into one file when possible*—Click this checkbox to combine all files of the same type into one file.

(For Brother Color Models Only) *Convert non-image files to color*—Click this checkbox to convert all files that have been processed through OCR to color.

### Show QuickSend Menu

Click this checkbox if you want the Select QuickSend Recipient window to be displayed when you choose Scan to E-mail. This feature works only with MAPI type E-mail applications, such as Microsoft Exchange, Microsoft Outlook and Eudora.

### QuickSend List

You can create a list of Email names and addresses for quick selection.

Click the **New** button to add a name(s) to your QuickSend list, Your Email phone book listing will be displayed, so you can select stored names or create new ones:

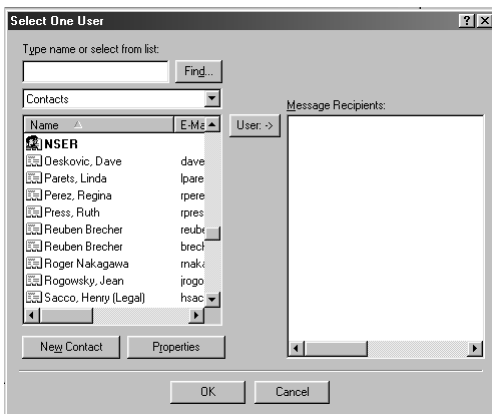

Highlight the name(s) you want to add to your list, and then click the **User** button. Click **OK** to return to the Link Preference window.

To remove a name from the QuickSend list in the Link Preference window, highlight the name and click the **Delete** button.

# Scan to Word Processor

---



## Scanner Settings

From the pull-down list, select the scanning mode that is appropriate for the type of file: Faxing, Filing and Copying; Text for OCR; Photos; Photos (High Quality); Photos (Quick Scan); Custom; Draft Copy or Fine Copy.

To change any of the settings for that mode, click the **Modify Settings...** button.

## Word Processor

*Word Processor*—From the pull-down list, select the word processor you want to use.

Click the **Link Settings...** button to display a screen to set up a link to the version of OCR and document format that you want to use:

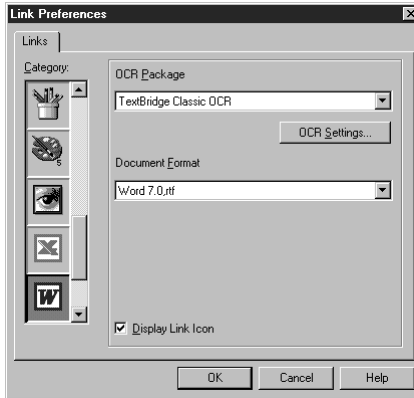

*OCR Package*—From the pull-down list, select *TextBridge Classic OCR* if you want to use the OCR package that was installed with the Brother software.

Click the **OCR Settings...** button to choose how the OCR application will read the pages you scan into your word processor application.

The Preferences window will appear:



Select your setting and click **OK**.

- *Auto Orientation*—Check this checkbox if you want your word processor application to read the page as it is set up.
- *Decolumnized Output*—Check this checkbox if you want your word processor application to read across the entire page from left to right.

*Document Format*—From the pull-down list, select the file format you want to use for your word processor or text documents.

# User-Defined Button

---

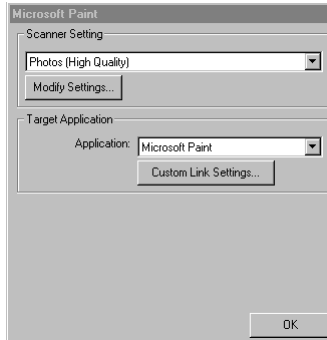

## Scanner Settings

From the pull-down list, select the scanning mode that is appropriate for the type of file: Faxing, Filing and Copying; Text for OCR; Photos; Photos (High Quality); Photos (Quick Scan); Custom; Draft Copy or Fine Copy.

To change any of the settings for that mode, click the **Modify Settings...** button.

## Target Application

*Application*—From the pull-down list, select the application you want to add to this Pop-Up screen.

Click the **Custom Link Settings...** button to set up links for your user-defined application.

# Copy

---

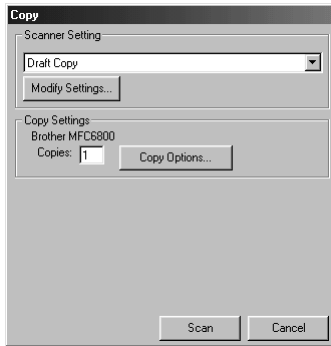

## Scanner Settings

From the pull-down list, select the scanning mode that is appropriate for the type of file: Faxing, Filing and Copying; Text for OCR; Photos; Photos (High Quality); Photos (Quick Scan); Custom; Draft Copy or Fine Copy.

To change any of the settings for that mode, click the **Modify Settings...** button.

## Copy Settings

Brother MFC-6800

*Copies*—Enter the number of copies you want to print.

To change the copy options, click the **Copy Options...** button.

Click the **OK** button to save your Copy settings.

# Send a Fax

---



## Scanner Settings

From the pull-down list, select the scanning mode that is appropriate for the type of file: Faxing, Filing and Copying; Text for OCR; Photos; Photos (High Quality); Photos (Quick Scan); Custom; Draft Copy or Fine Copy.

To change any of the settings for that mode, click the **Modify Settings...** button.

# FAX Settings

*Brother PC-Fax*

*FAX Resolution—Fine (200 × 200)*

- 1 To change the fax options, click the **FAX Options...** button.

The Brother PC-FAX Properties screen appears:

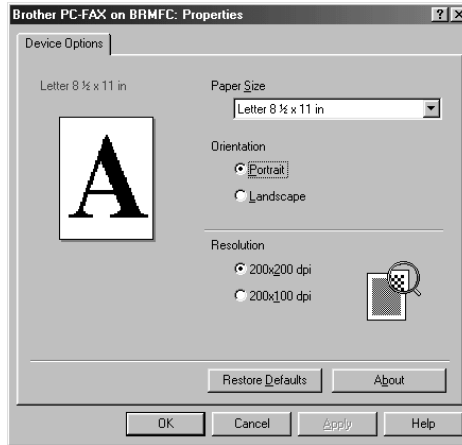

- 2 Select the *Paper Size and Orientation* (Portrait or Landscape) and click **OK**.



To return to the factory default settings, click the **Restore Defaults** button.



# 15 Scanner and Using ScanSoft™ PaperPort® and TextBridge® OCR

## Using ScanSoft™ PaperPort® and TextBridge®

ScanSoft™ Paper Port® for Brother is a document management application. You will use PaperPort® to view incoming faxes and scanned documents. PaperPort® has a sophisticated, yet easy-to-use, filing system that will help you organize your documents. It allows you to combine or “stack” documents of different formats for printing, faxing or filing. PaperPort® can be accessed through the PaperPort® program group. See *On-Line Documentation for Multi-Function Link® Pro* on the CD-ROM.

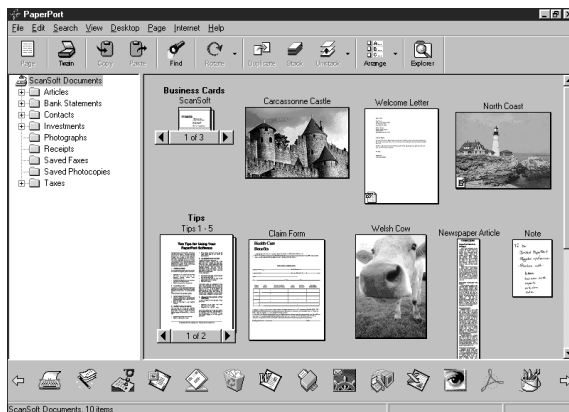

The complete ScanSoft™ PaperPort® Owner’s Manual, including ScanSoft™ TextBridge® OCR, is in the On-Line Documentation on the CD-ROM. This chapter is only an introduction to the basic operations.

When you install Multi-Function Link® Pro, ScanSoft™ PaperPort® for Brother and ScanSoft™ TextBridge® OCR are installed with it automatically.



### To Uninstall PaperPort® and ScanSoft™ TextBridge

For Windows® 95/98/98SE, and Windows NT® Workstation 4.0, Windows® ME and Windows® 2000 Professional:

Select **Start, Settings, Control Panel, Add/Remove Programs** and the **Install/Uninstall** tab. Select **PaperPort®** from the list and click the **Add/Remove** button.

## Viewing Items

PaperPort® provides several ways to view items: **Desktop View** displays a **thumbnail**, a small graphic that represents each item in a Desktop or folder. Items in the selected folder appear on the PaperPort® Desktop. You can see PaperPort® items (MAX files) and non-PaperPort® items (files created using other applications).

Non-PaperPort® items include an icon that indicates the application that was used to create the item; a non-PaperPort® item is represented by a small rectangular thumbnail and not an actual image.

**Page View** displays a close-up of a single page and you can open a PaperPort® item by double-clicking on it. As long as you have the appropriate application on your computer to display it, you can also double-click a non-PaperPort® item to open it.

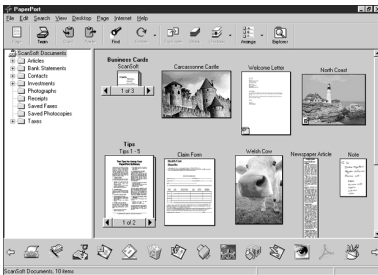

Desktop View displays items as thumbnails



Page View displays each item as a full page

## Organizing Your Items in Folders

PaperPort® has an easy-to-use filing system for organizing your items. The filing system consists of folders and items that you select to view in Desktop View. An item can be a PaperPort® item or a non-PaperPort® item:

- Folders are arranged in a “tree” structure in the Folder View. You use this pane to select folders and view their items in Desktop View.
- You can simply drag and drop an item onto a folder. When the folder is highlighted, release the mouse button and the item is stored in that folder.
- Folders can be “nested”—that is, stored in other folders.
- When you double-click a folder, its items (both PaperPort® MAX files and other files) appear on the Desktop.
- You can also use Windows® Explorer to manage the folders and items shown in Desktop View.

## Links to Many Other Applications

PaperPort® automatically recognizes many other applications on your computer and creates a “working link” to them. The Link Bar at the bottom of Desktop view shows icons of those linked applications. To use a link, drag an item onto one of the icons to start the application represented by the icon. A typical use of the Link Bar is to select an item and then fax it.

This sample Link Bar shows several applications with links to PaperPort®.



If PaperPort® does not automatically recognize one of the applications on your computer, you can manually create a link using the **Create New Link** command. (See *PaperPort® Help* for more information about creating new links.)

## Using ScanSoft™ TextBridge® OCR (Converting Image Text to Text You Can Edit)

Software by:



ScanSoft™ TextBridge® OCR is automatically installed with PaperPort® when you install Multi-Function Link® Pro on your computer.

PaperPort® can quickly convert the text on a PaperPort® item (which is really just a picture of the text) into text that you can edit with a word processing application. PaperPort® uses the optical character recognition application ScanSoft™ TextBridge, which comes with PaperPort®—**OR**—PaperPort® uses your application if it is already on your computer. You can convert the entire item, or by using the **Copy As Text** command, you can select only a portion of the text to convert.

Dragging an item onto a word-processing link icon starts PaperPort®’s built-in OCR application, or you can use your own OCR application.



## Importing Items from Other Applications

In addition to scanning items, you can bring items into PaperPort® in a variety of ways and convert them to PaperPort® (MAX) files in several different ways:

- Print to the Desktop View from another application, such as Microsoft Excel.
- Import files saved in other file formats, such as Windows® Bitmap (BMP) or Tag Image File Format (TIFF).

## Exporting Items in Other Formats

You can export or save PaperPort® items in several popular file formats. For Windows® 95/98/98SE, and Windows NT® Workstation Version 4.0, Windows® 2000 Professional and Windows® Me, you can export formats BMP, PCX, DCX, JPG, TIF, PDF, PNG, FPX, HFX, or self-viewing. For example, you could create a file for an Internet Web site and export it as a JPEG file. Web pages often use JPEG files for displaying images.

### Exporting an Image File

- 1 Select the Export command from the File pull-down menu in the PaperPort® window. The Export ‘XXXXX’ As dialog box will be displayed.
- 2 Select the drive and directory where you want to store the file.
- 3 Enter the new file name and choose the file type or select a name from the File Name text box. (You can scroll through the Directories and File Name listing for prompting.)
- 4 Select the **OK** button to save your file, or **Cancel** to return to the PaperPort® without saving it.

### Accessing the Scanner

To choose the TWAIN\_32 Brother MFL Pro Color as your scanner driver, select it under the “Select scanner”—**OR**—“Select source” option in your software.

From the PaperPort® window, select **Acquire** from the File drop-down menu or select the **TWAIN** or **Scan** button. The Multi-Function Link® Pro Scanner Setup dialog box will appear:

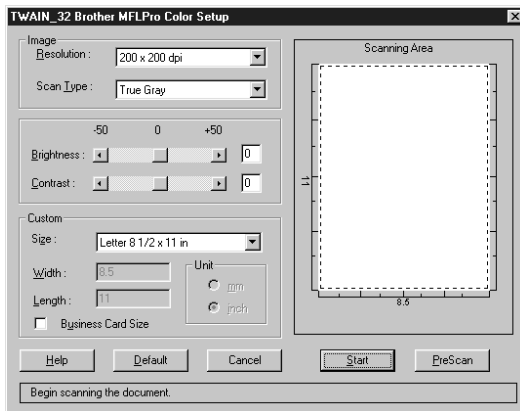

## Scanning an Image into Your PC

- 1 Place the original face up in the ADF, or face down on the scanner glass.
- 2 Adjust the following settings, if needed, in the Scanner Setup window:
  - Resolution
  - Scan Type (Black & White, Gray [Error Diffusion], True Gray)
  - Brightness
  - Contrast
  - Size
- 3 Select the **Start** button from the Scanner window.

When scanning is completed, close the scanner window. The PaperPort® screen will appear showing the image you scanned highlighted in red.

## Settings in the Scanner Window

### Image

#### **Resolution**

Select the scanning resolution from the Resolution drop down list. Higher resolutions take more memory and transfer time, but can achieve a finer scanned image.

#### **Scan Type**

**Black & White:** Set the Color Type to Black & White for text or line art.

**Gray Scale:** For photographic images, set the Color Type to Gray (Error Diffusion) or True Gray.

**Colors:** Choose either 256 Color, which scans up to 256 colors, 24-bit color which scans up to 16.8 million colors. Although using 24-bit color creates an image with the most accurate colors, the image file will be approximately three times larger than a file created with 256 Color.

#### **Brightness**

**Brightness:** Adjusting the brightness settings to obtain the best image. The Brother Multi-Function Link® Pro offers 100 brightness settings (-50 to 50). The default value is 0, representing an “average” setting.

You can set the brightness level by dragging the slider to the right to lighten the image or to the left to darken the image. You can also type a value in the box to set the settings.

If the scanned image is too light, set a lower brightness value and scan the document again.

If the image is too dark, set a higher brightness value and scan the document again.

## Contrast

The contrast setting is adjustable only when you have selected one of the gray scale settings, but it is not available when Black & White is selected as the gray Scale.

Increasing the contrast level (by dragging the slider to the right) emphasizes dark and light areas of the Image, while decreasing the contrast level (by dragging the slider to the left) reveals more detail in gray areas. Instead of using the slider, you can type a value in the box to set the contrast.

## Custom Size

Set the Size to one of the following:

- Letter (8 1/2 × 11 in.)
- A4 (210 × 297 mm.)
- Legal (8 1/2 × 14 in.)
- A5 (148 × 210 mm.)
- B5 (182 × 257 mm.)
- Executive (7 1/4 × 10 1/2 in.)
- Business Card (60 × 90 mm.)
- Custom (User adjustable from 0.35 × 0.35 in. to 8.5 × 14 in.)

*After* you select a custom size, you can adjust the scanning area further by using the left mouse button to drag the dotted outline of the scanning area. This is required when you want to crop an image when scanning.

### **Business Card Size**

To scan business cards, select the Business Card (60 × 90 mm.) size setting and place the business card at the top center of a carrier sheet.



Carrier sheets are available from your Dealer.

When scanning photographs or other images for use in a word processor or other graphics application, you should try different settings for the contrast, mode and resolution to see which settings best suit your needs.

## PreScanning an Image

PreScanning allows you to scan an image quickly at a low resolution. A thumbnail version of the image will appear in the Scanning Area. This is only a preview of the image so you can see how it will look. The PreScan button is used to preview an image for cropping any unwanted portions from the image. When you are satisfied with the preview, select the **Start** button to scan the image.

- 1 Place the original face up in the ADF, or face down on the scanner glass.
- 2 Select the **PreScan** button:

The entire original will be scanned into the PC and will appear in the Scanning Area of the Scanner window.

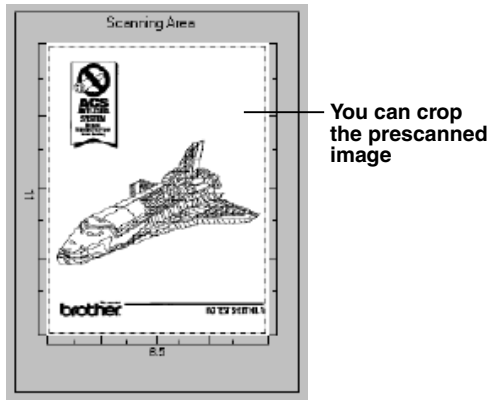

- 3 To crop a portion of the document to be scanned, drag any side or corner of the dotted outline in the Scanning Area with the left mouse button. Adjust the dotted outline until it surrounds only the portion of the original you wish to scan.
- 4 Place the original face up in the ADF again, if you used the ADF in Step 1.
- 5 Adjust the settings for Resolution, Scan Type, Brightness, Contrast, and Size in the Scanner Setup window, as needed.
- 6 Click **Start**.  
This time only the selected area of the document will appear in the PaperPort® window.
- 7 In the PaperPort® window, use the options available in the Markups pull-down menu and the Crop option in the Options pull-down menu to refine the image.

# 16 Setting Up and Using PC FAX (For Windows® Only)

## Introduction

---

This chapter outlines the basics of the Brother software, so you can get started using the Multi-Function Link® Pro Suite software. Detailed installation and setup instructions are in the On-Line Documentation section of the Brother CD-ROM that is included with your MFC.

Check the online **README.WRI** file in the root directory of the CD-ROM for last-minute important information and troubleshooting tips that were not included in the On-Line Documentation.

Multi-Function Link® Pro Suite software for your MFC includes ScanSoft™ PaperPort® for Brother and ScanSoft™ TextBridge®. (See Chapter 15, *Scanner and Using ScanSoft™ PaperPort® and TextBridge® OCR*.)

### Brother Resource Manager

The Brother Resource Manager application must be running for you to use your MFC with your Windows® computer. Multi-Function Link® Pro Suite software and the MFL Pro Suite Printer Driver automatically load the Resource Manager, as needed. The Resource Manager allows the single bi-directional Parallel port on the MFC to simulate a Communications port for faxing and scanning and to simulate a Parallel port for Windows® GDI printing.



# MFC Remote Setup

The MFC Remote Setup application allows you to quickly set up your MFC by taking advantage of the ease and speed of programming on your PC. When you access this application, the settings on your MFC will be downloaded automatically to your PC and displayed on your computer screen. If you change the settings, you can upload them directly to the MFC.

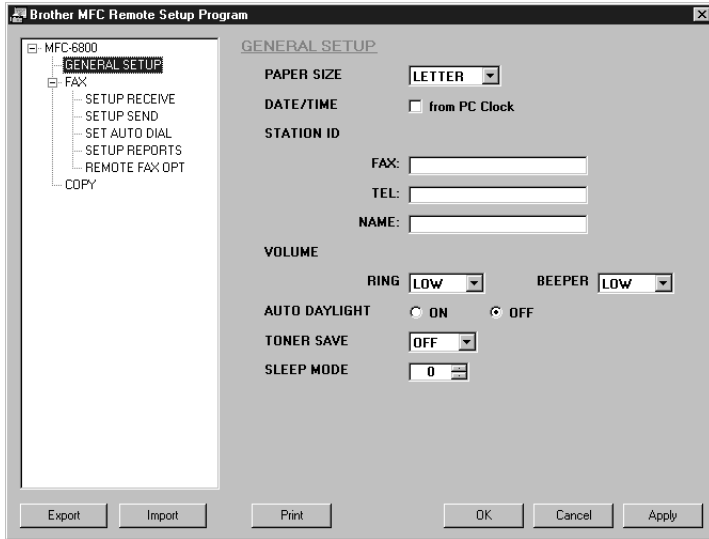

## OK

This starts the process of uploading the data to the MFC and exiting the remote setup program. If an error message is displayed enter the correct data again, then click **OK**.

## Cancel

This exits the remote setup application without uploading the data to the MFC.

## Apply

This uploads the data to the MFC, but does not exit the remote setup application.

## Print

This command prints the selected items on the MFC. You can not print the data until it is uploaded to the MFC. Click **Apply** to upload the new data to the MFC and click **Print**.

## Export

This command saves the current configuration settings to a file.

## Import

This command reads the settings from a file.

# PC FAX Sending (For Windows® Only)

The Brother PC FAX feature allows you to use your PC to send a file. You can create a file in any application on your PC, and then send it as a PC FAX. You can even attach a cover page note. All you have to do is set up the receiving parties as Members or Groups in your PC FAX Address Book. Then you can use the Address Book Search feature to quickly find them to address your fax.

## Setting Up User Information

- 1 From the **Start** menu, select **Programs, Brother, Brother MFL Pro Suite**, and then select **PC-FAX Setting**.

Note

You can access the User Information from the FAX Sending dialog box by clicking . (See *Sending a File as a PC-FAX Using the Facsimile Style*, page 16-14.)

The Brother PC Fax Setup dialog box will appear:

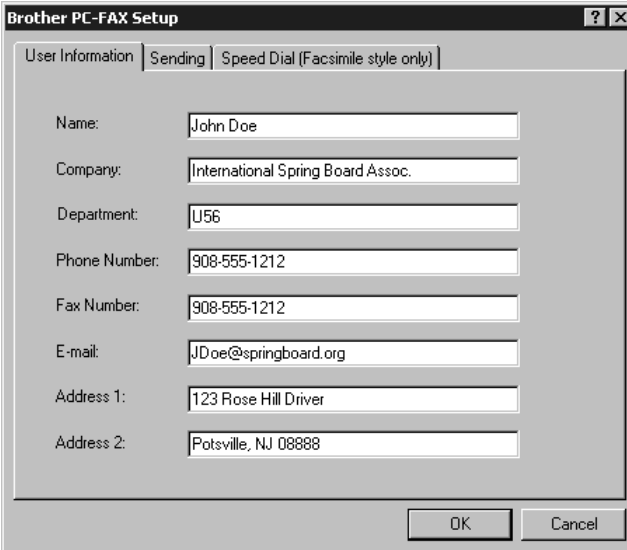

The screenshot shows the 'Brother PC-FAX Setup' dialog box with the 'User Information' tab selected. The fields are filled with the following data:

Field	Value
Name:	John Doe
Company:	International Spring Board Assoc.
Department:	U56
Phone Number:	908-555-1212
Fax Number:	908-555-1212
E-mail:	JDoe@springboard.org
Address 1:	123 Rose Hill Driver
Address 2:	Potsville, NJ 08888

Buttons: OK, Cancel

- 2 Enter the required User information. This information is required to create the Fax Header and Cover Page.
- 3 To save the User Information, click **OK**.

## Setting Up Sending

To access the Sending tab from the Brother PC-FAX Setup dialog box, click the **Sending** tab.

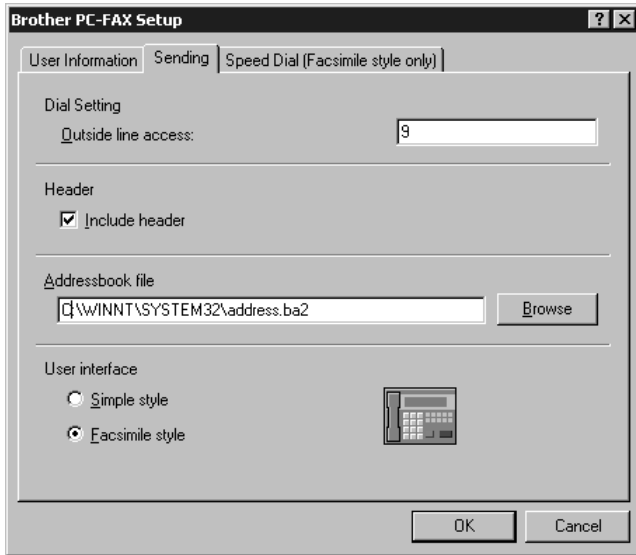

### Outside line access

Enter the number needed to access an outside line. This is sometimes required by the local PBX telephone system.

### Include header

To add header information to the top of the fax pages being sent, check the Header box.

### Address Book file

You can select different database files for use with the Address Book. You must enter the path and file name of the database file or use the Browse button to view the file system to select the file.

## User interface

Select the User Interface for the Sending dialog box. You have a choice of the Simple Style or the Facsimile Style.

### Simple Style

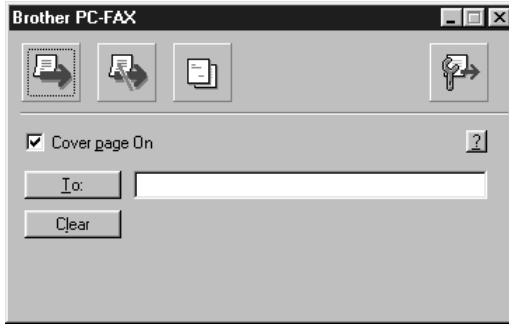

### Facsimile Style



## Setting Up Speed Dial

Access the Speed Dial tab from the Brother PC-Fax Setup dialog box by clicking the **Speed Dial** tab. (To use this feature you must select the Facsimile Style user interface.)

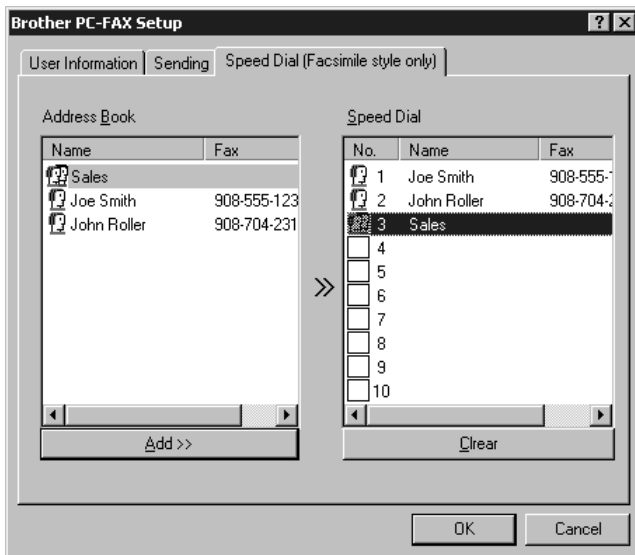

You can register any address or group on one of the ten Speed Dial buttons.

To register an address in a Speed Dial location:

- 1 Click the Speed Dial location you want to program.
- 2 Click the address or group you wish to assign to the Speed Dial location.
- 3 Click **Add >>** to program the Speed Dial location.

To clear a Speed Dial location:

- 1 Click the Speed Dial location you want to clear.
- 2 Click **Clear**.

## The Address Book

From the **Start** menu, select **Programs, Brother, Brother MFL Pro Suite**, and then click **Address Book**.

The Brother Address Book dialog box will appear:

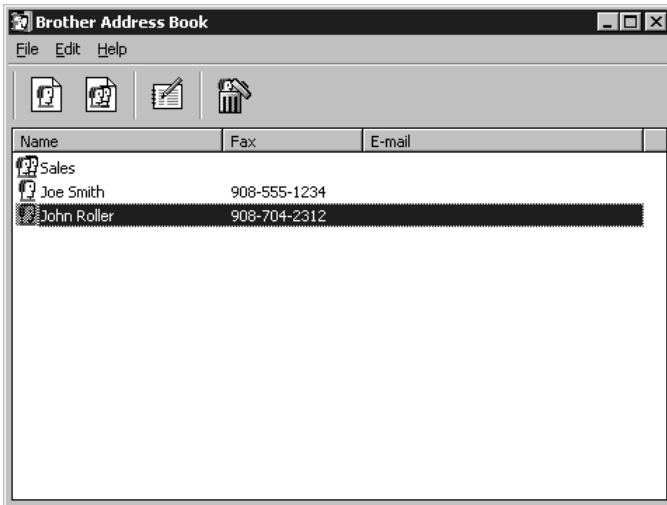

## Setting Up a Member in the Address Book

In the Brother Address Book dialog box you can add, edit and delete stored information for members and groups.

- 1 In the Address Book dialog box, click the  icon to add a member.

The Brother Address Book Member Setup dialog box will appear:

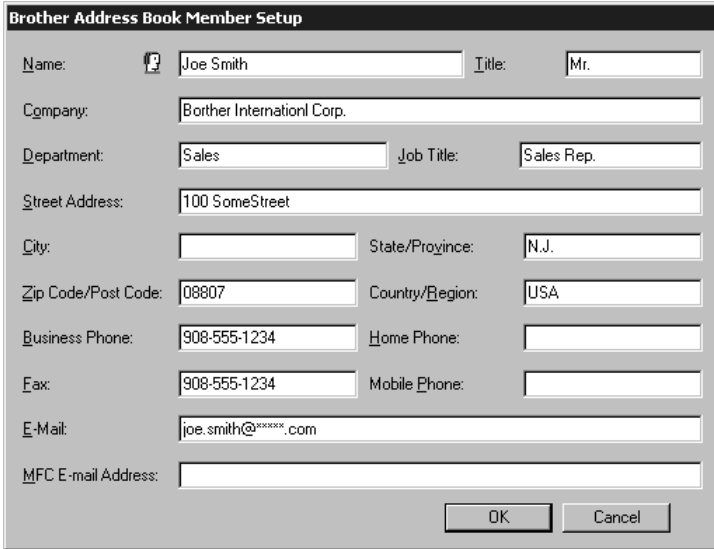

**Brother Address Book Member Setup**

Name:  Title:

Company:

Department:  Job Title:

Street Address:

City:  State/Province:

Zip Code/Post Code:  Country/Region:

Business Phone:  Home Phone:

Fax:  Mobile Phone:

E-Mail:

MFC E-mail Address:

- 2 In the Brother Address Book Member Setup dialog box, type the member's information. **Name** and **Fax** are required fields. Click **OK** to save the member's information.

## Setting Up a Group for Broadcasting

If you repeatedly send the same PC-FAX to multiple recipients, you can combine members into a Group.

- 1 In the Brother Address Book dialog box, click the  icon to create a group. The Brother Address Book Group Setup dialog box appears:

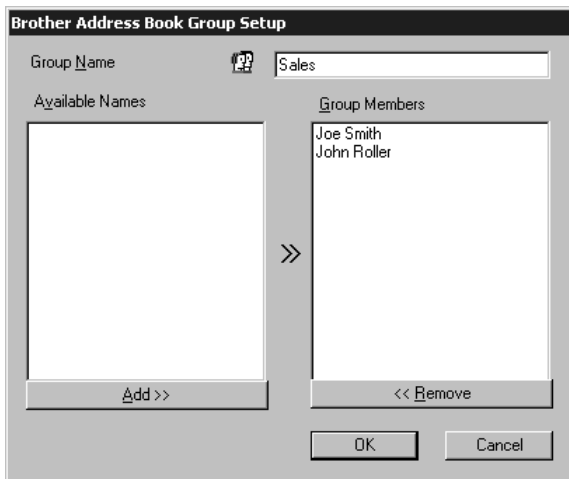

- 2 Type the name of the new group in the **Group Name** field.
- 3 In the **Available Names** box, select each member to be included in the Group, and then click **Add >>**.  
Members you add to the group will be listed in the Group Members box.
- 4 After all the members have been added, click **OK**.

## Editing Member Information

- 1 Select the Member or Group you want to edit.
- 2 Click the edit  icon.
- 3 Edit the Member or Group information.
- 4 Click **OK** to save your changes.



## Deleting a Member or Group

- 1 Select the Member of Group you want to delete.
- 2 Click the delete  icon.
- 3 Click **OK** when the Delete OK? Dialog box appears.

## Exporting the Address Book

You can export the Address Book to an ASCII text file (\*.csv). If you wish, you can create a Vcard for selected members that will be attached to all the sender's outgoing e-mail; a Vcard is an electronic business card that contains the sender's contact information.

### To export the current telephone book:



If you are creating a Vcard, you must first select the member.

- 1 From the Address Book select **File**, point to **Export**, and then click **Text**—**OR**—Click **Vcard** and go to Step 5.
- 2 Select the data fields you wish to Export from the **Available Items** column, and then click **Add >>**.



Select items in the order you want them listed.

- 3 If you are exporting to an ASCII file, select **Divide Character - Tab** or **Comma**. This selection inserts a Tab or Comma between each data field when it is Exported.
- 4 Select **OK** to save the data.

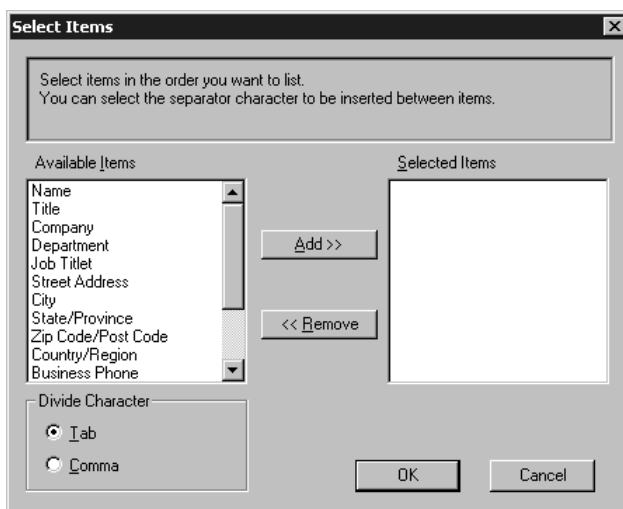

- 5 Type the name of the file, and then select **Save**.

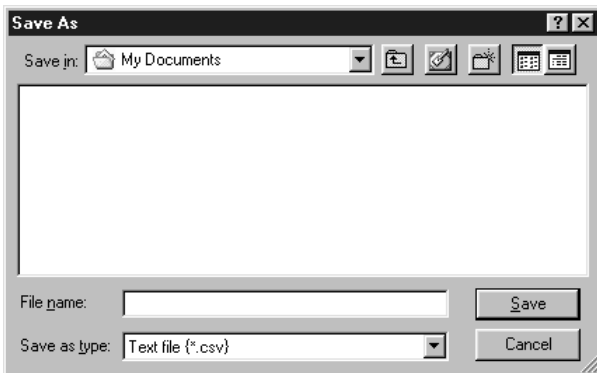

**Note** If you selected Vcard in Step 1, the **Save as type:** will be **Vcard (\*.vcf)**.

## Importing to the Address Book

You can import ASCII text files (\*.csv) or Vcards (electronic business card) into your Address Book.

### To import an ASCII text file:

- 1 From the Address Book select **File**, point to **Import**, and then click **Text** —**OR**—Click **Vcard** and go to Step 5.

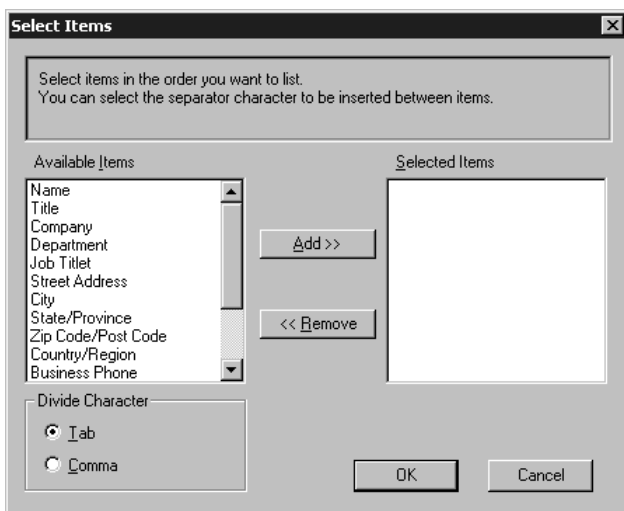

- 2 Select the data fields you wish to Import from the **Available Items** column, and then click **Add >>**.

**Note** Select the fields from the Available Items list in the same order they are listed in the Import text file.

- 3 Select **Divide Character - Tab** or **Comma** based on what file format you are importing.
- 4 Select **OK** to import the data.
- 5 Type the name of the file, and then select **Open**.

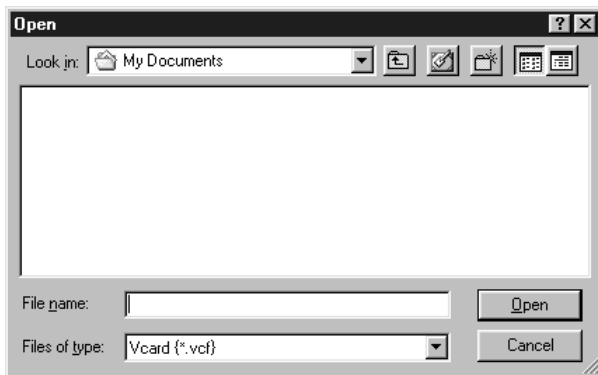

**Note** If you selected a text file in Step 1, the **Files of type:** will be **Text file (\*.csv)**.

## Setting Up a Cover Page

Access the Brother PC-FAX Cover Page Setup from the FAX Sending dialog box by clicking . (See *Sending a File as a PC-FAX Using the Facsimile Style*, page 16-14.) The Brother PC-FAX Cover Page Setup dialog box will appear:

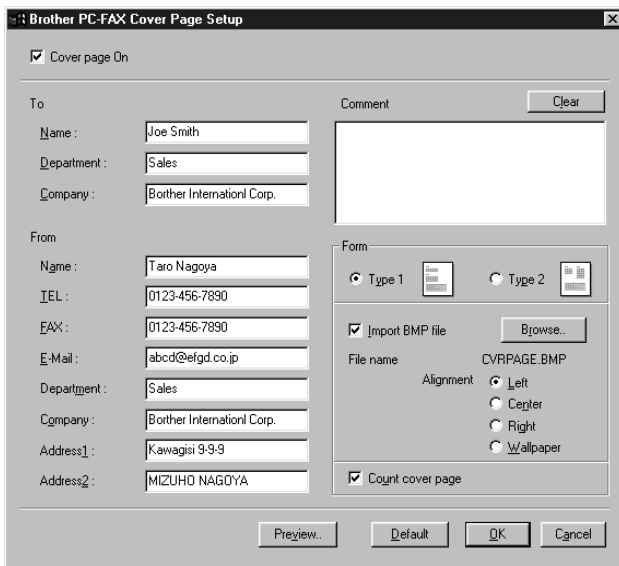

## **To**

You can enter information in each field.



If you are sending a fax to multiple recipients, the recipient information will not be printed on the Cover Page.

## **From**

You can enter information in each field.

## **Comment**

Type the comment you want to add to the cover page.

## **Select Cover Page Form**

Select the cover page form you want.

## **Import BMP file**

You can insert a bitmap file, such as your company logo, in the cover page.

Select the BMP file by using the browse button, and then select the alignment style.

## **Count Cover Page**

When the Count Cover Page box is checked, the Cover Page will be included in the page numbering. When this box is not checked, the Cover Page will not be included.

## Sending a File as a PC-FAX Using the Facsimile Style

- 1 Create a file in Word, Excel, Paint, Draw or any other application on your PC.
- 2 From the **File** menu, select **Print**.  
The Print dialog box will appear:

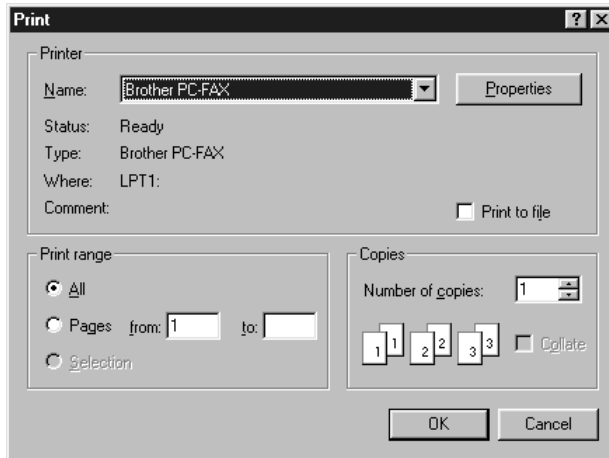

- 3 Select **Brother PC-FAX** as your printer, and then click **OK**.  
The FAX Sending dialog box will appear:



- 4 Enter the fax number by using any of the following methods:
- Enter the number using the dial pad.
  - Click any of the 10 **Speed Dial** buttons.
  - Click the **Address Book** button, and then select a Member or Group from the Address Book.



If you make a mistake you can use the **Clear** button to clear all the entries.

- 5 To include a cover page, click  **Cover Page On**, and then click the Cover Page  icon to enter or edit the cover page information.

- 6 Click **Start** to send the fax.



If you wish to cancel the fax, click **Stop**.

## Redial

If you want to redial a number, click **Redial** button to scroll through the last five fax numbers, and then click **Start**.

## Sending a File as a PC-FAX Using the Simple Style

- Create a file in Word, Excel, Paint, Draw or any other application on your PC.
- From the **File** menu, select **Print**.

The Print dialog box will appear:

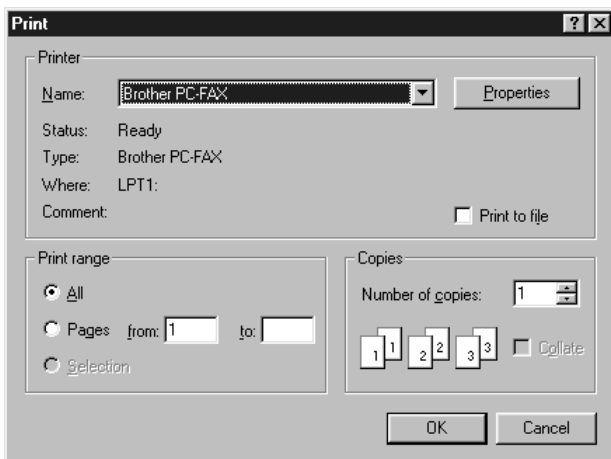

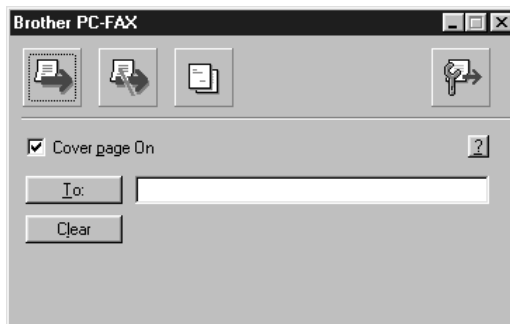

- 3 Select **Brother PC-FAX** as your printer, and then click **OK**.

The FAX Sending dialog box will appear:



- 4 In the **To:** field, type the fax number of the receiving party. You can also use the Address Book to select destination fax numbers by clicking **To:** button. If you made a mistake entering a number, click the **Clear** button to clear all entries.

- 5 To send a Cover Page and note, check the **Cover Page On** check box.

 You can also click the  to create or edit an existing cover page.

- 6 When you are ready to send your fax, click the Send  icon.

- 7 If you wish to cancel the fax, click the  icon.

# 17 Using Automatic E-Mail Printing

**For Windows® 95, 98, 98SE, Me Only**

---

## Main Features

- You can use Automatic E-Mail Printing with other E-mail software: Brother Automatic E-Mail Printing has some extra functions that other E-mail software, such as Netscape Navigator™ or MS Internet Mail, do not support.
- Automatic E-Mail Printing can be configured for a multiple user account: In Brother Automatic E-Mail Printing you can set up more than one e-mail account on a single PC so you can print e-mail in each account automatically.
- Automatic access to your specified POP3 server at the specified time: You can specify the time when the Brother Automatic E-Mail Printing automatically accesses the server to check for new mail.
- Provides an “In Memory” printer driver: You can receive and print e-mail data at the same time, by searching for a specified character string in the mail header. It allows you to see the sender, subject and relevant part of the mail content.

### Before You Use this Software

Please read *Using Automatic E-Mail Printing* in the **On-Line Documentation** on the CD-ROM. Check the online README.WRI file in the root directory of the CD-ROM for last-minute important information and troubleshooting tips not included in the On-Line Documentation.

### To Access the On-Line Documentation



After you have installed the Brother driver(s) for your model and operating system, click **View On-Line Documentation** for operating instructions.

### To Install Automatic E-mail Printing (Optional Application)

- 1 Insert MFL Pro CD-ROM into your CD-ROM drive.
- 2 Click **Install Software** from the main CD-ROM screen.
- 3 Click **Automatic E-mail Printing**.



*This is optional software and will not be required for printing, faxing and scanning operations.*

**The “Automatic E-mail Printing” option is NOT available for Windows NT® 4.0 and Windows® 2000 Professional.**



# 18 Using the Brother MFC with a New Power Macintosh® G3, G4 or iMac™/iBook

## Set up Your USB Equipped Apple® Macintosh® G3, G4, iMac™ or iBook with Mac OS 8.5/8.51/8.6/9.0/9.0.4/9.1

**Note** Before you can connect the MFC to your Macintosh®, you must purchase a USB cable that is no longer than 6 feet (1.8 meters).

To work with your MFC your USB Equipped Apple® Macintosh® must be set up with Mac OS 8.5/8.51/8.6/9.0/9.0.4/9.1 (The Brother Scanner Driver works only with Mac OS 8.6/9.0/9.0.4/9.1)

## Using Brother Printer Driver with Your Apple® Macintosh®

To select the Printer:

- 1 From the Apple menu, open the **Chooser**.

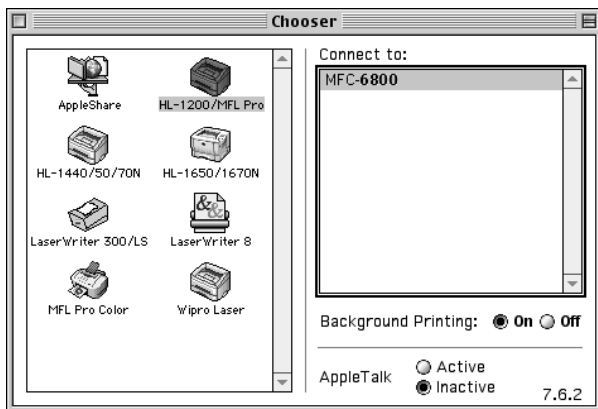

- 2 Click the **HL-1200/MFL Pro** icon. On the right side of the Chooser, click the printer to which you want to print. Close the Chooser.

### To print the document:

- From application software such as PaperPort®, click *File menu* and select *Page Setup*. You can change the settings for **Paper Size**, **Orientation** and **Scaling**, and then click **OK**.

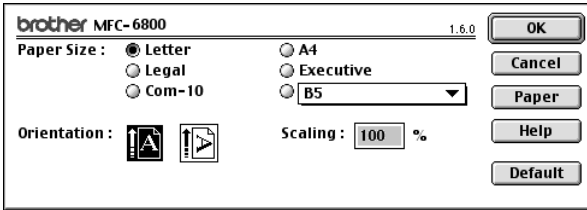

- From application software such as PaperPort, click *File menu* and select *Print*. Click **Print** to start printing.

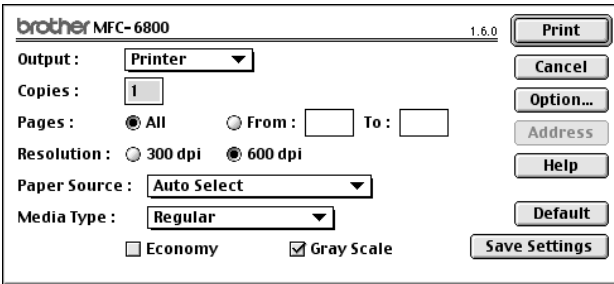

**Note** If you want to change **Copies**, **Pages**, **Resolution**, **Paper Source** and **Media Type**, select your settings before clicking **Print**.

Option Setup allows you to change **Duplex**.

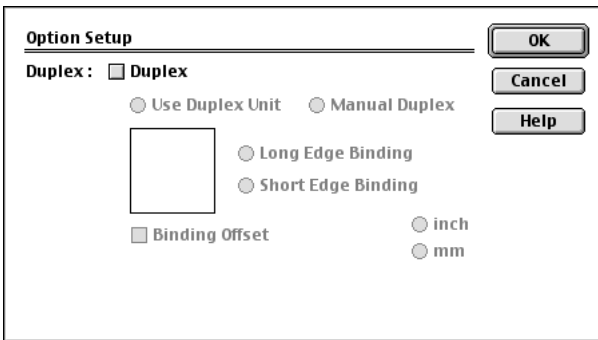

# ***Sending a Fax from Your Macintosh® Application***

You can send a fax directly from your Macintosh® application using the following steps:

- 1 Create a document in a Macintosh® application.
- 2 To begin the fax transmission, select **Print** from the **File** menu. The Printer dialog box appears:

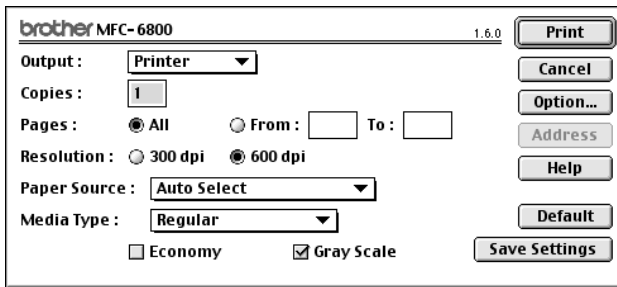

When **Printer** is selected, the top button shows **Print** and the **Address** button is grayed.

- 3 From the **Output** pull-down menu, select **Facsimile**.

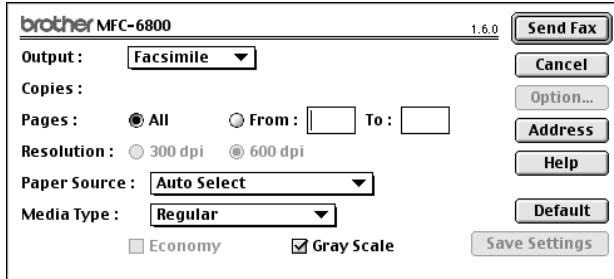

When **Facsimile** is selected, the top button shows **Send Fax** and the **Address** button is available.

#### 4 Click **Send Fax**.

The Send Fax dialog box appears:

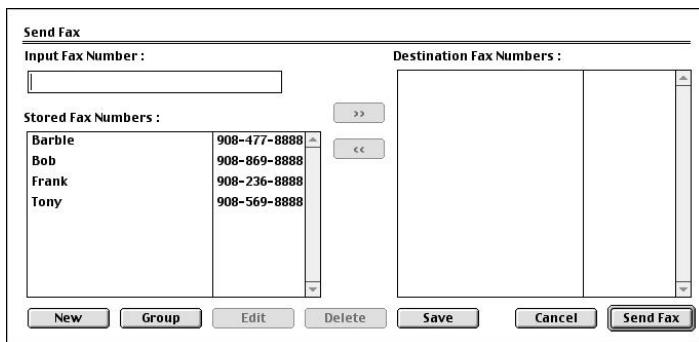

The Send Fax dialog box has two list boxes. The left box shows all the previously **Stored Fax Numbers**; the right box will show the **Destination Fax Numbers** as you select them.

#### 5 To address the fax, type a fax number in the **Input Fax Number** box.

—OR—

Select a name/number from the **Stored Fax Numbers** box, and then click . Your recipient will appear in the **Destination Fax Numbers** box.



You can select several stored numbers at once by using the Shift and Ctrl keys.

#### 6 If you want to, you can add your new recipients to the Address Book at this time by clicking **New** to open the Address Book dialog box. (See *Adding a New Member*, page 18-5.)

—OR—

You can add a new group by clicking **Group**. (See *Adding a New Group*, page 18-6.)



To select and send only certain pages of the document, click **OK** to return to the Print dialog box.

#### 7 If you are finished addressing your fax, click **Send Fax**. The Facsimile dialog box will reappear.



If you click Send Fax without addressing your fax, the following error message appears:

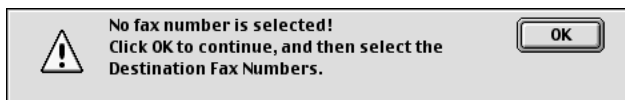

Click **OK** to return to the Send Fax dialog box.

## Setting Up Your Address Book

You can add new members and groups to your Address Book, even while you are addressing a fax.

### Adding a New Member

- 1 To add a new member to the Address Book, in the Facsimile dialog box click **Address**.

The Address Book dialog box appears:

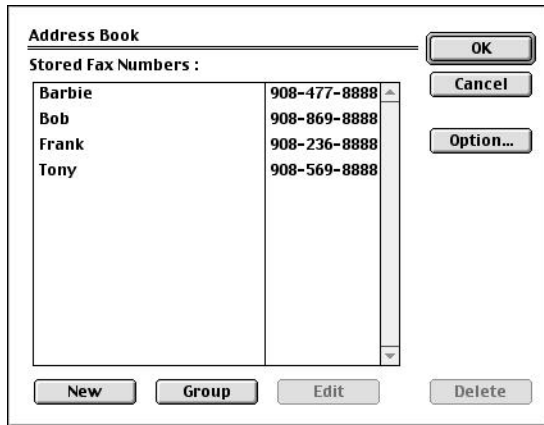

- 2 Click **New**. The following dialog box appears:

Name :

Fax# :

Memo :

- 3 Type the name and fax number.
- 4 If you want to, you can store a comment in the Memo field (up to 15 characters).
- 5 Click **OK** to return to the Address Book dialog box.

## Adding a New Group

You can set up a group of multiple recipients.

**1** Click **Group**.

The Group Setting dialog box appears.

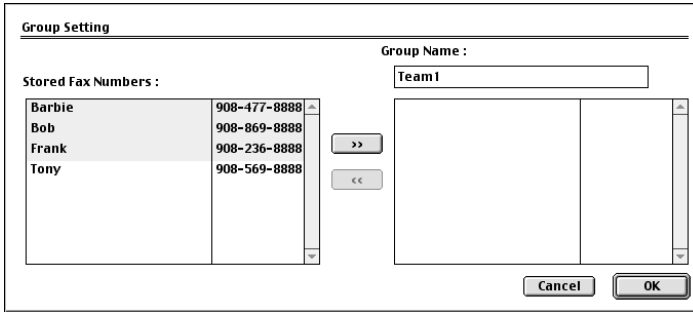

**2** In the Group Name field, type a name for your Group.

**3** From the **Stored Fax Numbers** box select the recipients for your Group, and then click **>>**.

Your selection will appear in the box under the **Group Name** field.

**4** Click **OK**.

The Address Book dialog box reappears:

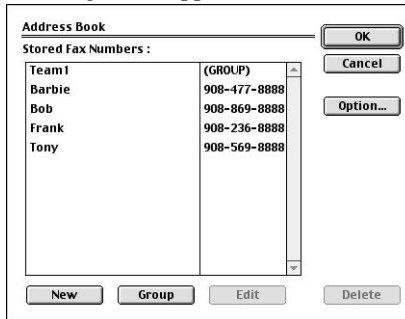

**5** Click **OK**.

The Print/Facsimile dialog box reappears:

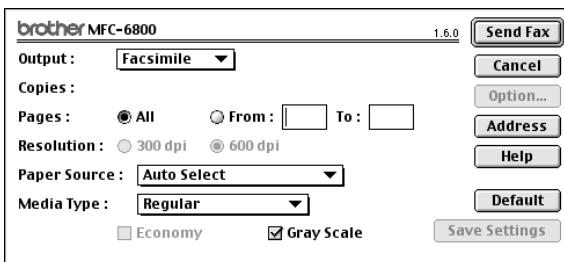

**6** If you are ready to send your fax, click **Send Fax**.  
(Follow the steps on page 18-3 for sending a fax.)

# Using Brother TWAIN Scanner Driver with Your Apple® Macintosh®

The Brother MFC software includes a TWAIN Scanner driver for Macintosh®. This Macintosh® TWAIN Scanner driver can be used with applications that support the TWAIN specification. You can use PaperPort® for scanning.

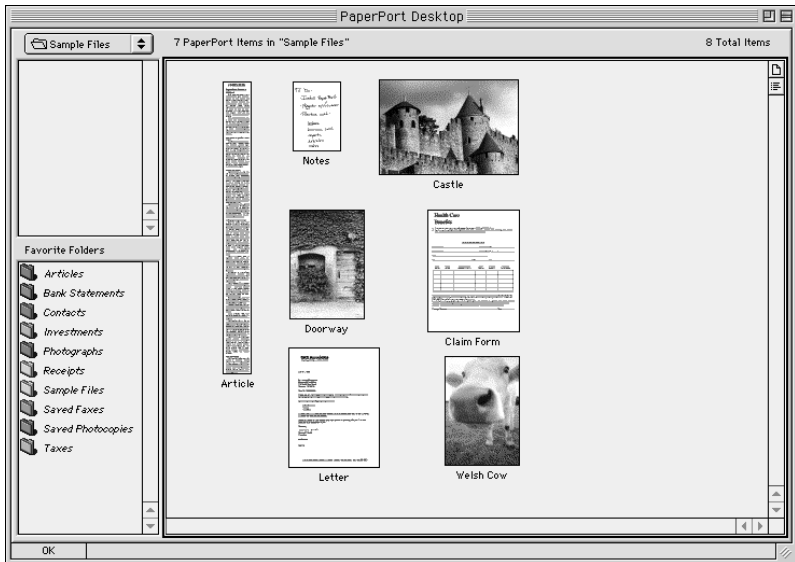

## Accessing the Scanner

Run your PaperPort® software. You will see the **PaperPort®** icon in the upper right corner of your screen. The first time you use the Brother TWAIN driver, set it as the default by choosing *Select Source* and clicking the *PaperPort®* icon. Afterward, for each original you scan, choose *Acquire Image* by clicking the *PaperPort®* icon. The Scanner setup dialog box will appear.

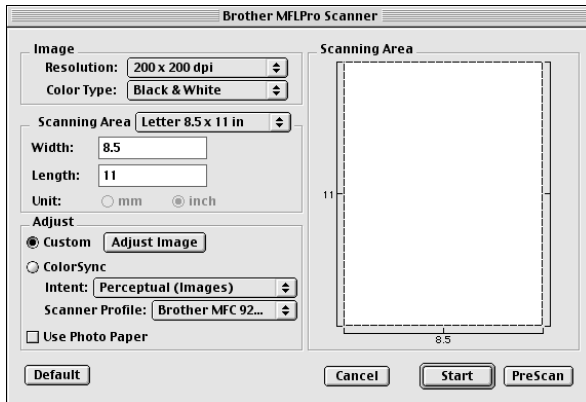

## Scanning an Image into Your Macintosh G3, G4 or iMac

- 1 Place the original face up in the ADF, or face down on the scanner glass.
- 2 Adjust the following settings, if needed, in the scanner setup dialog box:
  - Resolution*
  - Color Type*
  - Brightness*
  - Contrast*
  - Scanning Area*
- 3 Click **Start**.

When scanning is finished, the image will appear in your graphics application.



## Settings in the Scanner Window

### Image

#### *Resolution*

Choose the scanning resolution from the Resolution pop-up menu. Higher resolutions take more memory and transfer time, but can achieve a finer scanned image.

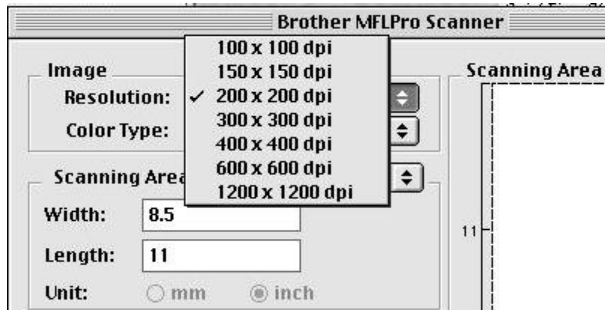

#### *Color Type*

*Black & White*—Set the image Type to Black&White for text or line art. For photographic images, set the image type to Gray (Error diffusion) or True Gray.

*Gray (Error Diffusion)*—is used for documents that contain photographic images or graphics. (Error Diffusion is a method for creating simulated gray images by placing black dots in a specific matrix instead of true gray dots.)

*True Gray*—also is used for documents containing photographic images or graphics. This mode is more exact because it uses up to 256 shades of gray. It requires the most memory and longest transfer time.

*Colors*—Choose either 256 Color, which scans up to 256 colors, 24-bit color which scans up to 16.8 million colors. Although using 24-bit color creates an image with the most accurate colors, the image file will be approximately three times larger than a file created with 256 Color.

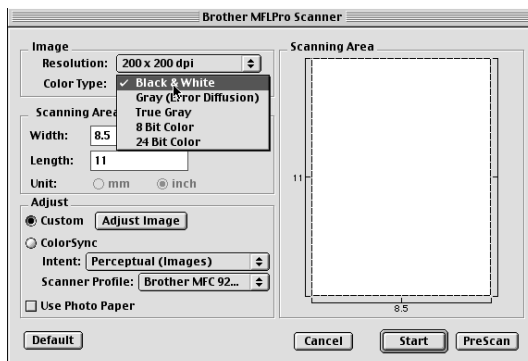

## Scanning Area

Set the **Size** to one of the following:

- *Letter* (8.5 × 11 inches)
- *A4* (210 × 297 mm)
- *Legal* (8.5 × 14 inches)
- *A5* (148 × 210 mm)
- *B5* (182 × 257 mm)
- *Executive* (7.25 × 10.5 inches)
- *Business Card* (90 × 60 mm)
- *Custom* (User adjustable from 0.35 × 0.35 inches to 8.5 × 14 inches)

After you choose a custom size, you can adjust the scanning area. Click and hold the mouse button as you drag the mouse to crop the image.

Width: Enter the width of the custom size.

Length: Enter the length of the custom size.

## Business Card Size

To scan business cards, select the Business Card size setting (90 × 60 mm), and then place the business card at the top center of a carrier sheet.



Carrier sheets are available from your Dealer.

When scanning photographs or other images for use in a word processor or other graphics application, it is a good idea to try different settings for the Contrast, Mode and Resolution to determine which settings look best.

## Adjust Image

### *Brightness*

Adjust the Brightness settings to obtain the best image. The Brother TWAIN Scanner driver offers 100 Brightness settings (-50 to 50). The default value is 0, representing an “average” setting.

You can set the Brightness level by dragging the slider to the right to lighten the image or to the left to darken the image. You can also type a value in the box to set the setting. Click **OK**.

If the scanned image is too light, set a lower Brightness value and scan the document again.

If the image is too dark, set a higher Brightness value and scan the document again.

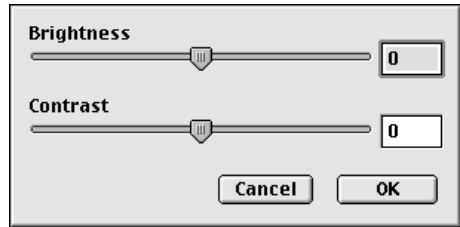

### *Contrast*

The Contrast setting is adjustable only when you have selected one of the gray scale settings, but it is not available when Black & White is selected as the Gray Scale.

Increasing the Contrast level (by dragging the slider to the right) emphasizes dark and light areas of the image, while decreasing the Contrast level (by dragging the slider to the left) reveals more detail in gray areas. Instead of using the slider, you can type a value in the box to set the Contrast. Click **OK**.

## PreScanning an Image

PreScanning allows you to scan an image quickly at a low resolution. A thumbnail version will appear in the Scanning Area. This is only a preview of the image, so you can see how it will look. The PreScan button is used to preview an image for any unwanted portions. When you are satisfied with the preview, click Start to scan the image.

- 1 Insert the original face up in the ADF, or face down on the scanner glass.
- 2 Click **PreScan**.  
The entire original will be scanned into your Macintosh G3 or iMac and will appear in the Scanning Area of the Scanner dialog box:
- 3 To scan a portion of the prescanned image, click and drag the mouse to crop it.

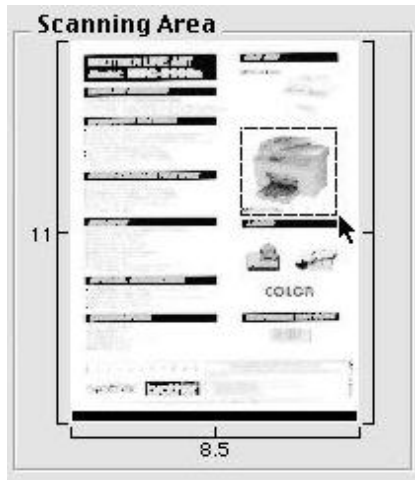

- 4 Insert the original face up in the ADF, or face down on the scanner glass again.
- 5 Adjust the settings for Resolution, Color Type (Gray Scale), Brightness, Contrast, and Size in the Scanner Setup dialog box, as needed.
- 6 Click **Start**.  
This time only the selected area of the original will appear in the Scanning Area.
- 7 Use your application, software for editing and refining the image.

# 19 Important Information

## ***Standard Telephone and FCC Notices***

---

**These notices are in effect on models sold and used in the United States only.**

**When programming emergency numbers and making test calls to emergency numbers:**

- Remain on the line and briefly explain to the dispatcher the reason for the call before hanging up.
- Perform these activities in the off-peak hours, such as early morning or late evening.

This equipment complies with Part 68 of FCC Rules. On the rear panel of this equipment is a label that contains, among other information, the FCC Registration Number and Ringer Equivalence Number (REN) for this equipment. You must, upon request, provide this information to your telephone company.

You may safely connect this equipment to the telephone line by means of a standard modular jack, USOC RJ11C.

An FCC compliant telephone cord with a modular plug is provided with this equipment. This equipment is designed to be connected to the telephone line or premises wiring using a compatible modular jack that is Part 68 compliant. See the Installation section of this manual for details.

The REN is useful to determine the quantity of devices you may connect to your telephone line and still have those devices ring when your telephone number is called. In most, but not all areas, the sum of the RENs of all devices connected to one line should not exceed five (5). To be certain of the number of devices you may connect to your line, as determined by the REN, you should contact your local telephone company to determine the maximum REN for your calling area. If your MFC-6800 damages the telephone line, the telephone company may discontinue your service temporarily. If possible, they will notify you in advance. But if advanced notice is not practical, you will be notified as soon as possible. You will be informed of your right to file a complaint with the FCC.

Your telephone company may make changes to its facilities, equipment, operations or procedures that could affect the proper functioning of your equipment. If they do, you will be notified in advance to give you an opportunity to maintain uninterrupted telephone service.

If you experience trouble with your MFC-6800, please contact a Brother Authorized Service Center for information on obtaining service or repair. The telephone company may ask that you disconnect this equipment from the line until the problem has been corrected or until you are sure that the equipment is not malfunctioning.

If you are not able to solve a problem with your MFC, contact Brother Customer Service. (See *Brother Numbers*, page i.)

## **WARNING**

For protection against the risk of electrical shock, always disconnect all cables from the wall outlet before servicing, modifying or installing the equipment.

This equipment may not be used on coin service lines provided by the telephone company or connected to party lines.

Brother cannot accept any financial or other responsibilities that may be the result of your use of this information, including direct, special or consequential damages. There are no warranties extended or granted by this document.

## **Laser Safety**

This equipment is certified as a Class I laser product under the U.S. Department of Health and Human Services (DHHS) Radiation Performance Standard according to the Radiation Control for Health and Safety Act of 1968. This means that the equipment does not produce hazardous laser radiation.

Since radiation emitted inside the equipment is completely confined within protective housings and external covers, the laser beam cannot escape from the machine during any phase of user operation.

## **FDA Regulations**

U.S. Food and Drug Administration (FDA) has implemented regulations for laser products manufactured on and after August 2, 1976. Compliance is mandatory for products marketed in the United States. One of the following labels on the back of the machine indicates compliance with the FDA regulations and must be attached to laser products marketed in the United States.

### **Manufactured**

BROTHER CORP. (ASIA) LTD.

BROTHER BUJI NAN LING FACTORY

Gold Garden Industry, Nan Ling Village, Buji, Rong, Gang, Shenzhen, China.

This product complies with FDA radiation performance standards, 21 CFR Subchapter J.

## **WARNING**

Use of controls, adjustments or performance of procedures other than those specified in this manual may result in hazardous invisible radiation exposure.



## Caution

Changes or modifications not expressly approved by Brother Industries, Ltd. may void the user's authority to operate the equipment.

## Federal Communications Commission (FCC) Declaration of Conformity (For USA Only)

Responsible Party:	Brother International Corporation 100 Somerset Corporate Boulevard Bridgewater, NJ 08807-0911 USA TEL: (908) 704-1700
--------------------	--

declares, that the products

Product Name: MFC-6800

comply with Part 15 of the FCC Rules. Operation is subject to the following two conditions: (1) This device may not cause harmful interference, and (2) this device must accept any interference received, including interference that may cause undesired operation.

This equipment has been tested and found to comply with the limits for a Class B digital device, pursuant to Part 15 of the FCC Rules. These limits are designed to provide reasonable protection against harmful interference in a residential installation. This equipment generates, uses, and can radiate radio frequency energy and, if not installed and used in accordance with the instructions, may cause harmful interference to radio communications. However, there is no guarantee that interference will not occur in a particular installation. If this equipment does cause harmful interference to radio or television reception, which can be determined by turning the equipment off and on, the user is encouraged to try to correct the interference by one or more of the following measures:

- Reorient or relocate the receiving antenna.
- Increase the separation between the equipment and receiver.
- Connect the equipment into an outlet on a circuit different from that to which the receiver is connected.
- Consult the dealer or an experienced radio/TV technician for help.

## Important

Changes or modifications not expressly approved by Brother Industries, Ltd. could void the user's authority to operate the equipment.

## Industry Canada Compliance Statement

This Class B digital apparatus complies with Canadian ICES-003.

Cet appareil numérique de la classe B est conforme à la norme NMB-003 du Canada.

## Important—About the Interface Cable

A shielded interface cable should be used in order to ensure compliance with the limits for a Class B digital device.

## Warranty

You must use the IEEE-1284 shielded parallel cable provided by Brother Industries, Ltd. (See *Ordering Accessories and Supplies*, page ii)—**OR**—Attach a free filter core to your standard shielded printer cable. (To receive a free filter core with instructions, call 1-877-BROTHER (**in USA**) or 1-877-BROTHER (**in Canada**) and order item number FCYL2.)

## International ENERGY STAR® Compliance Statement

As an ENERGY STAR® Partner, Brother Industries, Ltd. has determined that product meets the ENERGY STAR® guidelines for energy efficiency.





## ***Important Safety Instructions***

---

- 1** Read all of these instructions.
- 2** Save them for later reference.
- 3** Follow all warnings and instructions marked on the product.
- 4** Unplug this product from the wall outlet before cleaning. Do not use liquid or aerosol cleaners. Use a damp cloth for cleaning.
- 5** Do not place this product on an unstable cart, stand, or table. The product may fall, causing serious damage to the product.
- 6** Slots and openings in the cabinet and the back or bottom are provided for ventilation; to ensure reliable operation of the product and to protect it from overheating, these openings must not be blocked or covered. The openings should never be blocked by placing the product on a bed, sofa, rug, or other similar surface. This product should never be placed near or over a radiator or heater. This product should never be placed in a built-in installation unless proper ventilation is provided.
- 7** This product should be operated from the type of power source indicated on the label. If you are not sure of the type of power available, consult your dealer or local power company.
- 8** This product is equipped with a 3-wire grounding type plug, a plug having a third (grounding) pin. This plug will fit into only a grounding-type power outlet. This is a safety feature. If you are unable to insert the plug into the outlet, contact your electrician to replace your obsolete outlet. Do not defeat the purpose of the grounding-type plug by using an adapter.
- 9** Do not allow anything to rest on the power cord. Do not place this product where people can walk on the cord.
- 10** If an extension cord is used with this product, make sure that the total ampere ratings on the products plugged into the extension cord do not exceed the extension cord ampere rating. Also, make sure that the total of all products plugged into the wall outlet does not exceed 15 amperes (USA only).
- 11** Never push objects of any kind into this product through cabinet slots, since they may touch dangerous voltage points or short out parts resulting in the risk of fire or electric shock. Never spill liquid of any kind on the product.
- 12** This product must be installed near a power outlet that is easily accessible. In case of emergencies, you must disconnect the power cord from the power outlet in order to shut off power completely.

- 13** Unplug this product from the wall outlet and refer servicing to Authorized Service Personnel under the following conditions:
- A** When the power cord is damaged or frayed.
  - B** If liquid has been spilled into the product.
  - C** If the product has been exposed to rain or water.
  - D** If the product does not operate normally when the operating instructions are followed. Adjust only those controls that are covered by the operating instructions. Improper adjustment of other controls may result in damage and will often require extensive work by a qualified technician to restore the product to normal operation.
  - E** If the product has been dropped or the cabinet has been damaged.
  - F** If the product exhibits a distinct change in performance, indicating a need for service.
- 14** Do not attempt to service this product yourself, as opening or removing covers may expose you to dangerous voltage points and/or other risks, and may void your warranty. Refer all servicing to Authorized Service Personnel. A list of Authorized Service Centers has been included for your convenience, or you may contact Customer Service for your nearest Brother Authorized Service Center. (See *Brother Numbers*, page i. )
- 15** To protect your product against power surges, we recommend the use of a power protection device (Surge Protector).
- 16** When using your telephone equipment, basic safety precautions should always be followed to reduce the risk of fire, electric shock and injury to persons, including the following:
- Do not use this product near water (for example, near a bathtub, sink, swimming pool or in a wet basement).
  - Do not use the machine's telephone during an electrical storm (there is the remote possibility of an electrical shock) or to report a gas leak in the vicinity of the leak.
  - Use only the power cord indicated in this manual.

## **Trademarks**

---

The Brother logo is a registered trademark of Brother Industries, Ltd.

Brother is a registered trademark of Brother Industries, Ltd.

Multi-Function Link is a registered trademark of Brother Industries, Ltd.

© Copyright 2000 Brother Industries, Ltd. All rights reserved.

Windows, Windows NT, Microsoft, MS-DOS, Excel, Word, Paint and Draw are registered trademarks of Microsoft in the U.S. and other countries.

NT is a trademark of Northern Telecom Limited.

Macintosh and Quick Draw are registered trademarks and iMac and iBook are trademarks of Apple Computer, Inc.

PaperPort and TextBridge are registered trademarks of ScanSoft, Inc.

Each company whose software title is mentioned in this manual has a Software License Agreement specific to its proprietary programs.

IBM, IBM PC and Proprinter are registered trademarks of International Business Machines Corporation.

Hammermill copyplus white is a registered trademark of International Paper.

**All other brand and product names mentioned in this manual are registered trademarks of their respective companies.**

# 20 Troubleshooting and Routine Maintenance

## Troubleshooting

### IMPORTANT

For technical and operational assistance, you must call the country where you purchased the MFC. Calls must be made *from within* that country.

### Error Messages

You may occasionally encounter a difficulty with your MFC or telephone line. If this happens, your MFC often identifies the problem and displays an error message. The list below explains the most common error messages. You can correct most problems yourself. If you need additional help, call the Brother fax-back system at

**In USA:** 1-800-521-2846

ERROR MESSAGE	CAUSE	ACTION
<b>CHANGE DRUM SOON</b>	The drum unit is near the end of its life.	Use the drum unit until you have a print quality problem, then replace the drum unit with a new one.
<b>CHECK PAPER</b>	The MFC is out of paper or paper is not properly loaded in the multi-purpose sheet feeder.	Refill the paper or remove the paper and load it again and then press <b>Fax Start</b> .
<b>CHECK PAPER SIZE</b>	Your Paper Size setting may not be set correctly for the paper you are using (see page 4-1).	Change either paper in the multi-purpose sheet feeder or change paper size setting, and then press <b>Fax Start</b> .
<b>COMM. ERROR</b>	A poor quality phone line caused communications error.	Try the call again.
<b>CONNECTION FAIL</b>	You tried to poll a fax machine that is not in Polled Waiting mode.	Verify the other party's polling setup.

ERROR MESSAGE	CAUSE	ACTION
<b>COOLING DOWN WAIT FOR A WHILE</b>	The temperature of the drum unit or toner cartridge is too hot. The MFC will pause its current print job and go into cooling down mode. During the cooling down mode, you will hear the cooling fan running while the display on the MFC shows <b>COOLING DOWN</b> and <b>WAIT FOR A WHILE</b> .	You must wait and allow the MFC to resume printing when it is ready.
<b>COVER OPEN PLS CLOSE COVER</b>	The top cover was not completely closed.	Open, then close the cover.
<b>DISCONNECTED</b>	The other party or other party's MFC terminated the call.	Try to fax or receive again or call the other party to see what happened.
<b>DOC. COVER OPEN</b>	The document cover is open.	Remove any paper from the ADF and close the document cover.
<b>CHECK ORIGINAL</b>	Originals were not inserted or fed properly or original was too long.	Do not pull out the jammed original until you see page 20-5.
<b>MACHINE ERROR XX</b>	The MFC has a mechanical problem.	Turn off the power. Then call Brother Customer Service: <b>In USA:</b> 1-800-284-4329 <b>In Canada:</b> 1-877-BROTHER <b>In Montreal:</b> 1-514-685-6464

ERROR MESSAGE	CAUSE	ACTION
<p><b>OUT OF MEMORY</b> (May occur when the MFC is used as a printer.)</p>	<p>Machine memory capacity has been exceeded.</p>	<p>Turn off the power, and then turn it back on. Data remaining in the memory of the MFC will be deleted.</p> <ul style="list-style-type: none"> <li>• If you have installed the Windows® driver, try again after setting the True Type mode to “Print as Graphics” in the PRINT menu of your application software.</li> <li>• Reduce the print resolution or reduce the complexity of your document.</li> </ul>
<p><b>NO RESPONSE/ BUSY</b></p>	<p>The number you called does not answer or is busy. Or, you may have reached a number that is not connected to a fax machine.</p>	<p>Check the number and try again.</p>
<p><b>NOT REGISTERED</b></p>	<p>You tried to access a Speed Dial number that is not programmed.</p>	<p>Set up the Speed Dial number. See pages 7-1 to 7-2.</p>
<p><b>PLS OPEN COVER</b></p>	<p>A page, piece of paper or paper clip, etc. may be jammed inside the MFC.</p>	<p>Open the top cover. If you see any jammed paper or other item, gently pull it out, then close the top cover. If the error message remains, open and close the top cover again. If the MFC cannot reset itself and return to the date and time prompt, it will display <b>MACHINE ERROR XX</b>. Please call Brother Customer Service and tell them the Machine Error number at:</p> <p><b>In USA:</b> 1-800-284-4329</p> <p><b>In Canada:</b> 1-877-BROTHER</p> <p><b>In Montreal:</b> 1-514-685-6464</p>

<b>ERROR MESSAGE</b>	<b>CAUSE</b>	<b>ACTION</b>
<b>PAPER JAM</b>	The paper is jammed in the MFC.	Do not pull the paper out until you see pages 20-5 to 20-6.
<b>CHECK DRUM UNIT</b>	Drum unit is not installed.	Reinstall the drum unit.
<b>TONER EMPTY</b>	Toner is used up and printing is not possible, or the toner cartridge is not installed into the drum unit.	Replace the toner cartridge with a new one, or install the cartridge into the drum unit (See pages 20-19 to 20-23).
<b>TONER LOW</b>	If the LCD shows <b>TONER LOW</b> , you can still print. But the toner is depleted and the fax machine is telling you that the toner will soon run out.	Order a new toner cartridge now.

# Document Jams and Paper Jams

---

Based upon where the original or printed sheet is jammed, follow the appropriate set of instructions to remove it.

## Original is Jammed in the Top of the ADF Unit

- 1 Remove any paper from the ADF that is not jammed.
- 2 Lift the ADF cover.
- 3 Pull the jammed original out to the right.
- 4 Close the ADF cover.
- 5 Press **Stop/Exit**.

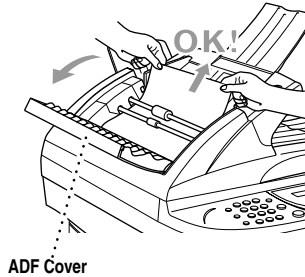

## Original is Jammed Inside the ADF Unit

- 1 Remove any paper from the ADF that is not jammed.
- 2 Lift the document cover.
- 3 Pull the jammed original out to the right.
- 4 Press **Stop/Exit**.

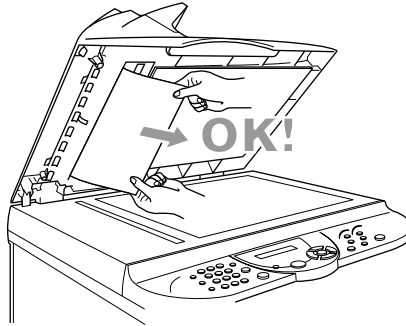



## Printer Jam

Before you can clear a paper jam error, you must find out where the paper is stuck. Review the following two types of printer jams and follow the instructions.

### WARNING

Do not force the jammed paper from the paper tray because you may damage the MFC and cause toner to scatter on the next printed pages.

After you have used the MFC, some internal parts of the machine are extremely **HOT!** When you open the top cover of the MFC, never touch the internal parts shown in the following picture.

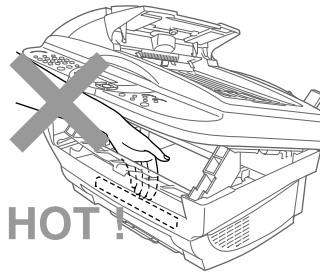

### Paper is Jammed in the Multi-purpose Sheet Feeder

- 1 Push down the paper lever, and then pull the jammed paper upward and out of the feeder.
- 2 Open the top cover and check that a torn piece of paper does not remain inside the MFC.

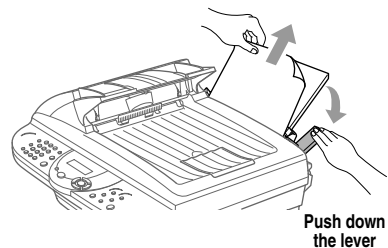

## Paper is Jammed near the Drum Unit

- 1 Open the top cover.
- 2 Remove the drum unit.
- 3 Gently pull out the jammed paper.
- 4 Reinstall the drum unit.
- 5 Close the top cover.

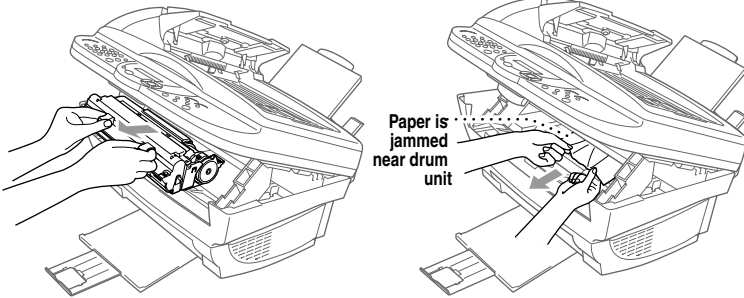

## If You Are Having Difficulty with Your MFC

If you think there is a problem with your MFC, *make a copy first*. If the copy looks good, the problem is probably not your MFC. Check the table below and follow the troubleshooting tips.



DIFFICULTY	SUGGESTIONS
<b>Printing and Receiving Faxes</b>	
<p>Condensed print and horizontal streaks; top and bottom of sentences are cut off.</p>	<p>If your copy looks good, you probably had a bad connection, with static or interference on the phone line. If the copy looks bad, clean the scanner area. If there is still a problem, call Brother Customer Service at: 1-800-284-4329 <b>(in USA)</b> or 1-877-BROTHER <b>(in Canada)</b> or 1-514-685-6464 <b>(in Montreal)</b>.</p>
<p>Vertical streaks; black lines appear on the faxes you receive.</p>	<p>Sometimes you may see vertical streaks/black lines on the faxes you receive. Either your MFC's primary corona wire for printing may be dirty, or the sending party's fax scanner may be dirty. Clean your primary corona wire (see pages 20-19), or ask the sender to make a copy to see if the problem is with the sending machine. Try receiving from another fax machine. If the problem continues, call Brother Customer Service at: 1-800-284-4329 <b>(in USA)</b> or 1-877-BROTHER <b>(in Canada)</b> or 1-514-685-6464 <b>(in Montreal)</b>.</p>
<p>The MFC "hears" voice as CNG tone.</p>	<p>If your MFC is set to Easy Receive ON, it is more sensitive to sounds. Your MFC may mistakenly interpret certain voices or music on the line as a calling fax machine and respond with fax receiving tones. Deactivate the MFC by pressing <b>Stop/Exit</b>. Try avoiding this problem by turning Easy Receive to OFF. (See <i>Easy Receive</i>, page 5-3.)</p>
<p>Horizontal streaks; lines are missing.</p>	<p>You may get a fax with horizontal streaks or with missing lines. Usually this is caused by a poor telephone connection. Ask the other party to send the fax again.</p>
<p>Received faxes appear as split or blank pages.</p>	<p>If the received data is divided and printed on two pages or if you get an additional blank page, your Paper Size setting may not be correct for the paper you are using (see pages 4-1). If you are using the fixed reduction feature, check to see if the reduction ratio is suitable for the real paper. (See page 11-4).</p>

DIFFICULTY	SUGGESTIONS
<b>Phone Line or Connections</b>	
The MFC does not answer when called.	Make sure the MFC is in the correct receiving mode for your setup (either <b>FAX ONLY</b> , <b>EXT.TEL/TAD</b> or <b>MANUAL</b> (for Distinctive Ring). Check for dial tone. If possible, call your MFC to hear it answer. If there is still no answer, check the telephone line cord connection. Connect a standard telephone handset to the MFC telephone jack. If there is no ringing when you call your MFC, call your telephone company to check the line.
<b>Sending Faxes</b>	
Transmitting quality is poor.	Try changing your resolution to <b>FINE</b> or <b>SUPERFINE</b> (See <i>Fax Resolution</i> , page 6-7). Make a copy to verify the MFC's scanner operation.
Transmission Verification Report prints "Results:NG".	There is probably temporary noise or static on the phone line. Try sending the fax again. If the problem continues, call the telephone company to check your phone line.
The receiving party says the picture is not clear.	Sometimes the resolution mode you chose when you sent your fax was not appropriate. Send the fax again, but try using the <b>FINE</b> or <b>SUPERFINE</b> mode. Also, your MFC's scanner may be dirty, so try cleaning it. (See pages 20-17)
The receiving party says vertical streaks appear on the faxes they receive.	Your MFC's scanner may be dirty or the receiving party's print head may be dirty. Clean your scanner (see pages 20-17), and then make a copy to check if the problem was caused by your machine.



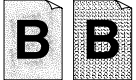

DIFFICULTY	SUGGESTIONS
<b>Handling Incoming Calls</b>	
I have difficulty transferring a fax call to the MFC.	If you answered at an extension phone, press your MFC's Remote Activation Code (default setting is *51). When your MFC answers, hang up.
I have difficulty with custom features on a single line.	<p>If you have Call Waiting, Call Waiting/Caller ID, Ring Master, Voice Mail, an alarm system or any other custom feature on a single phone line with your MFC, it may create a problem sending or receiving fax data.</p> <p>For example:</p> <p>If you are sending or receiving a fax message while a custom feature signal comes through the line, the signal can temporarily interrupt or disrupt the fax data. Brother's ECM feature should help overcome this problem. This condition is related to the telephone system industry and is common to all devices that send and receive information on a single shared line with custom features. If avoiding a slight interruption is crucial to your business, a separate line with no custom features is recommended.</p>

DIFFICULTY	SUGGESTIONS
<b>General Printing Difficulties</b>	
The MFC does not print.	Check the following: <ul style="list-style-type: none"> <li>• The MFC is turned on.</li> <li>• The toner cartridge and drum unit are installed properly.</li> <li>• The interface cable is securely connected between the MFC and computer.</li> <li>• Check to see if LCD is showing an error message. (See pages 20-1 to 20-4.)</li> </ul>
The MFC prints unexpectedly or it prints garbage.	Reset the MFC. Check the primary settings in your application software to make sure it is set up to work with your MFC.
The MFC prints the first couple of pages correctly, then some pages have text missing.	Your computer is not recognizing the printer input buffer's full signal. Please make sure to connect the printer cable correctly.
The MFC cannot print full pages of a document; <b>OUT OF MEMORY</b> error message occurs.	Reduce the printer resolution. Reduce the complexity of your document and try again. Reduce the graphic quality or the number of font sizes within your application software.
My headers or footers appear when I view my document on the screen, but do not appear when I print them.	Most laser printers have a restricted area that will not accept print. Usually these are the first two lines and last two lines, leaves 62 printable lines. Adjust the top and bottom margins in your document to allow for this.

DIFFICULTY	SUGGESTIONS
<b>Windows® Setup Printing Difficulties</b>	
I cannot print from my application software.	Make sure the Windows® printer driver is installed and that you selected it in your application software.
Sometimes I get the error message <b>OUT OF MEMORY</b> when printing certain documents from Windows®.	If you are using the supplied Windows® driver, turn the error recover operation on in the Setup dialog box and try again. Reduce the print resolution or reduce the complexity of your document and try again.
The MFC does not load paper. The LCD shows <b>CHECK PAPER</b> or <b>PAPER JAM</b> .	Check to see if the <b>CHECK PAPER</b> or <b>PAPER JAM</b> message appears on the LCD. If so, the multi-purpose sheet feeder may be out of paper or not properly installed. If it is empty, load a new stack of paper into the feeder and then press <b>Fax Start</b> . If there is paper in the multi-purpose sheet feeder, make sure it is straight. If the paper is curled, you should straighten it. Sometimes it is helpful to remove the paper, turn the stack over and place it back into the multi-purpose sheet feeder. Reduce the amount of paper in the multi-purpose sheet feeder, and then try again.
How can I load envelopes?	You can load envelopes from the multi-purpose sheet feeder. Your application software must be set up to print the envelope size you are using. This is usually done in the Page Setup or Document Setup menu of your software. Refer to your application manual.
What paper can I use?	You can use plain paper, envelopes, organizer paper, transparencies and labels for <i>laser</i> machines. For information on paper you can use, (See <i>Acceptable Paper</i> on pages 2-7.)
How can I clear paper jams?	(See <i>Printer Jam</i> on pages 20-6 to 20-7.)
<b>Copy Quality Difficulties</b>	
Vertical streaks appear in copies.	Sometimes you may see vertical streaks on your copies. Either the scanner or the primary corona wire for printing is dirty. Clean them both. (See pages 20-17 to 20-19.)

DIFFICULTY	SUGGESTIONS
<b>Print Quality Difficulties</b>	
Printed pages are curled.	Thin Paper (17lb-18.4lb) can cause this problem. Make sure you select the Paper Type that suits the paper in your multi-purpose sheet feeder. (See <i>Paper Type</i> , page 11-7 and 11-9 and <i>Media Type</i> , page 13-4.)
Printed pages are smeared.	Rough surfaces or thick media can cause “smeared pages”— <b>OR</b> —“the toner to smear”. Make sure you select the correct Paper Type that suits the paper in your multi-purpose sheet feeder. (See <i>Paper Type</i> , page 11-7 and 11-9 and <i>Media Type</i> , page 13-4.)
Printouts are too dark or too light.	Adjust the print conditions by setting the Print Density light function. It has been factory set to the middle position. (See <i>Setting the Print Density</i> , page 5-4.)
Printed pages contain white stripes.    <b>White Stripes or Faint Images</b>	You may fix this by wiping the scanner windows with a clean soft cloth. (See <i>Cleaning the Scanner</i> , page 20-17 and <i>Replacing the Drum Unit</i> , page 20-24.) If you still see white stripes or faint images and the LCD shows <b>CHANGE DRUM SOON</b> , replace the drum unit with a new one.
Printed pages are stained with toner or have vertical stripes.    <b>Dark Stripes or Toner Stains</b>	Clean the MFC’s interior and the primary corona wire of the toner cartridge. (See <i>Routine Maintenance</i> , page 20-17 and <i>Cleaning the Drum Unit</i> , page 20-19.) Make sure that the tab of the corona wire is at the home position. If after cleaning, you still see dark stripes or toner stains and the LCD shows <b>CHANGE DRUM SOON</b> , replace the drum unit with a new one.
Printed pages have white in black text and graphic areas.    <b>White Spots</b>	Make sure that you use paper that meets the specifications. Rough surface or thick media can cause the problem. If you still see white spots and the LCD shows <b>CHANGE DRUM SOON</b> , replace the drum unit with a new one.
Toner scatters and stains the printed page.    <b>Scattering Toner</b>	Adjust the print conditions by setting the Print Density function. Remove the drum unit and clean the MFC’s interior. (See <i>Routine Maintenance</i> , page 20-17, <i>Cleaning the Printer</i> , page 20-18 and <i>Cleaning the Drum Unit</i> , page 20-19.) Make sure that you use paper that meets specifications. (See page 2-7.) If you still have scattered toner and the LCD shows <b>CHANGE DRUM SOON</b> , replace the drum unit with a new one.

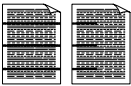
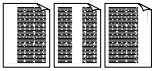

DIFFICULTY	SUGGESTIONS
<b>Print Quality Difficulties (CONTINUED)</b>	
<p>The whole page is printed black.</p>  <p style="text-align: center;"><b>Black Page</b></p>	<p>Wipe the electric terminals referring to See page 20-18. Also, do not use heat-sensitive paper as it will cause this problem. After cleaning, if the printed pages are still black and the LCD shows <b>CHANGE DRUM SOON</b>, replace the drum unit with a new one.</p>
<p>Nothing is printed on the page.</p>  <p style="text-align: center;"><b>White page</b></p>	<p>Make sure that the toner cartridge is not empty. Wipe the electric terminals. (See <i>Routine Maintenance</i>, page 20-17, <i>Cleaning the Printer</i>, page 20-18 and <i>Cleaning the Drum Unit</i>, page 20-19.) Make sure that a torn piece of paper does not remain on the scanner window.</p>
<p>Printed pages are marked at regular intervals.</p>  <p style="text-align: center;"><b>Example of Regular Mark</b></p>	<p>Marks may disappear by themselves. Try copying multiple pages to clear this problem. Marks may occur if the MFC has not been used for a long time. A possible cause is that the surface of the drum is scratched. You must then replace the drum unit with a new one. If the Marks do not disappear, it may be that the drum was marked or damaged by excessive exposure to light. In this case, replace the drum unit with a new one.</p>
<p>Printed pages are blurred at the center or at either edge.</p>  <p style="text-align: center;"><b>Blurred Page</b></p>	<p>Certain environmental conditions such as humidity, high temperatures, etc. may cause this condition to occur. Make sure the MFC is placed on a flat, horizontal surface. Remove the drum unit with the toner cartridge installed. Try rocking them from side to side. You may clear a blurred page by wiping the scanner windows with a clean soft cloth. (See <i>Routine Maintenance</i>, page 20-17, <i>Cleaning the Printer</i>, page 20-18 and <i>Cleaning the Drum Unit</i>, page 20-19.) If a blurred page occurs after cleaning and the LCD shows <b>CHANGE DRUM SOON</b>, replace the drum unit with a new one.</p>
<p>Ghost images appear on printed pages.</p>  <p style="text-align: center;"><b>Ghost Images</b></p>	<p>Adjust the print conditions by changing the Print Density setting, page 5-4.—<b>OR</b>— Rough surfaces or thick media can cause a ghost image. Make sure you select the Paper Type that suits the paper in your multi-purpose sheet feeder. (See <i>Paper Type</i>, page 11-7 and 11-9 and <i>Media Type</i>, page 13-4.)</p>



The drum unit is a consumable item and it is necessary to replace it periodically.

# Packing and Shipping the MFC

---

Whenever you transport the MFC, use the packing materials that came with your MFC. If you do not pack the MFC correctly, you could void your warranty.

- 1 Unplug the MFC from the telephone wall jack.
- 2 Unplug the MFC from the AC outlet.

## WARNING

Do not unplug the MFC after a print job until you hear the final click.

- 3 Open the top cover.
- 4 Remove the drum unit.

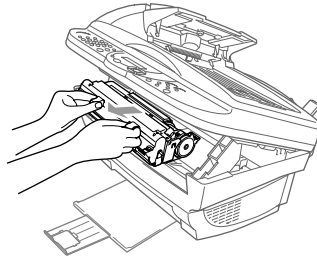

## Caution

Remove the drum unit and toner cartridge assembly. Leave the toner cartridge installed in the drum unit.

- 5 Place the drum unit and toner cartridge assembly into the plastic bag and seal the bag completely.

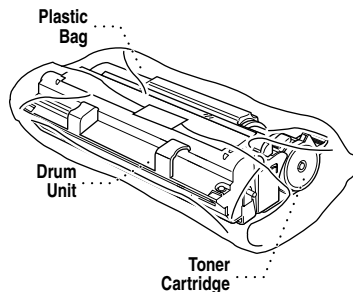

- 6 Close the top cover. Remove the paper support and close the paper tray and extension.

- 7 Wrap the MFC in the plastic bag and place it in the original carton with the original packing material.

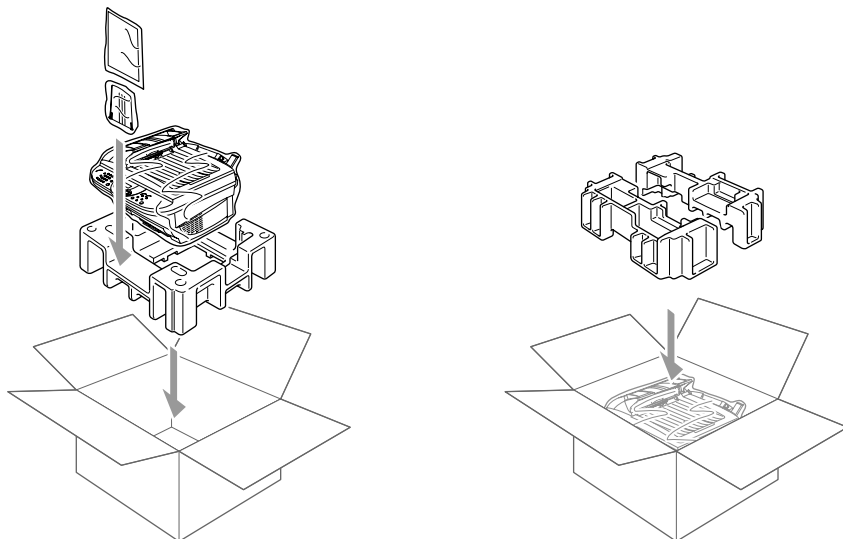

- 8 Pack the drum unit and toner cartridge assembly, telephone line cord and AC cord in the original carton as shown below:

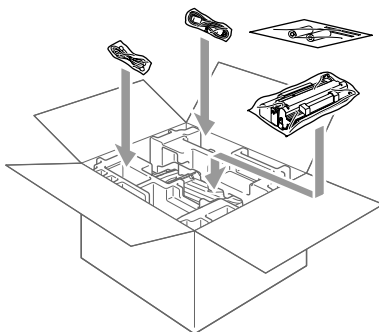

**Note** If you are returning the MFC to Brother as part of the Exchange Service, pack *only* the MFC.

Keep all separate parts to use with your “Exchange” machine.

- 9 Close the carton and tape it shut.

# Routine Maintenance

---

## Cleaning the Scanner

Turn the MFC power switch OFF and lift the document cover. Clean the scanner glass and the white film with isopropyl alcohol on a lint free cloth.

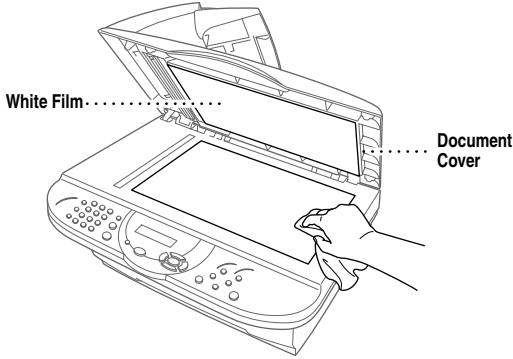

Lift the ADF unit. Clean the white bar and the glass strip with isopropyl alcohol on a lint-free cloth.

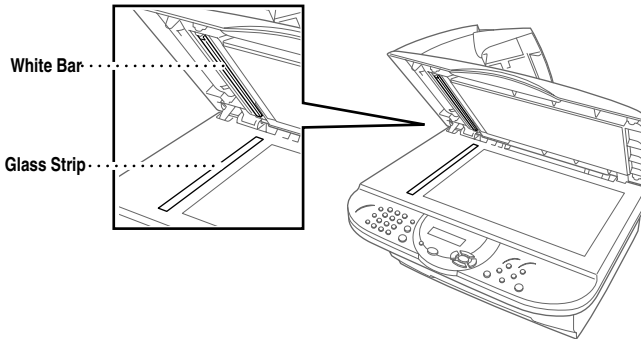

## Cleaning the Printer

### ! Caution

- Do not use isopropyl alcohol to remove dirt from the control panel. It may cause a crack on the panel.
- Do not use isopropyl alcohol to clean the scanner window or the toner sensor.
- Do not touch the scanner window with your finger.
- Handle the drum unit carefully because it contains toner. If toner scatters and your hands or clothes get dirty, immediately wipe or wash it off with cold water.

- 1 Open the top cover.
- 2 Remove the drum unit assembly.

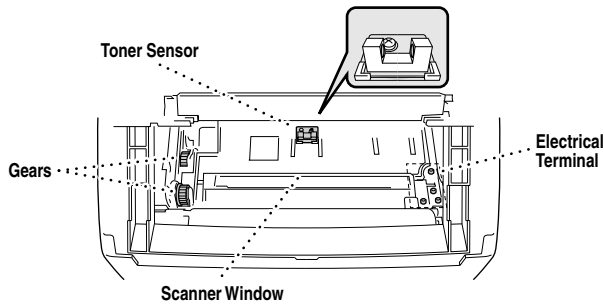

### ! WARNING

Just after you have used the MFC, some internal parts of the machine are extremely **HOT!** When you open the top cover of the MFC, never touch the internal part shown in the following picture.

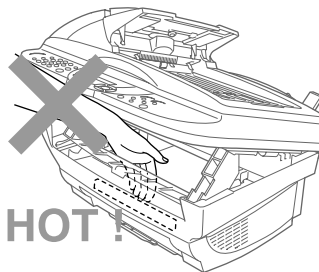

- 3 Wipe the electric terminals with isopropyl alcohol on a cotton swab.
- 4 Wipe the gears with a clean dry cloth.
- 5 Gently wipe the scanner window and the toner sensor with a clean soft dry cloth. Do NOT use isopropyl alcohol to clean the scanner window or the toner sensor.

## Cleaning the Drum Unit

We recommend you place the drum unit on a drop cloth or large piece of disposable paper to avoid spilling and scattering toner.

- 1 Carefully turn the drum unit upside down.
- 2 Clean the primary corona wire inside the drum unit by gently sliding the tab from right to left several times.
- 3 Return the tab to the Home position ( ▼ ) before reinstalling the drum unit.

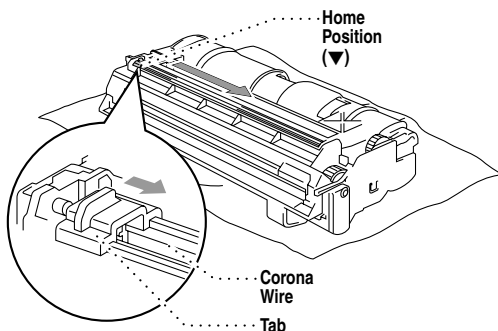

### ! Caution

If you do not position the tab at the Home position ( ▼ ), printed pages may have vertical stripes.

- 4 Re-install the drum unit into the MFC.  
(See *Replacing the Drum Unit*, page 20-24.)
- 5 Close the top cover.

## Replacing the Toner Cartridge

The MFC can print approximately 2,200 pages with one toner cartridge. When the toner cartridge is running low, the LCD shows **TONER LOW**. The MFC is supplied with a *starter* toner cartridge that must be replaced after 1,000 pages. Actual page count will vary depending on your average document type (i.e. standard letter, detailed graphics).

It is a good idea to keep a new toner cartridge ready for use when you see the **TONER LOW** warning.

Discard the used toner cartridge according to local regulations. If you are not sure of them, call your local Sanitation Department. Be sure to seal the toner cartridge tightly so toner powder does not spill out of the cartridge. When discarding used toner cartridges, keep them separate from domestic garbage.



We recommend that you clean the MFC when you replace the toner cartridge.

## Toner Empty Indicator

When the toner cartridge is running low, the display shows **TONER LOW** and the Toner Empty LED on the control panel flashes on and off to indicate the toner is low.

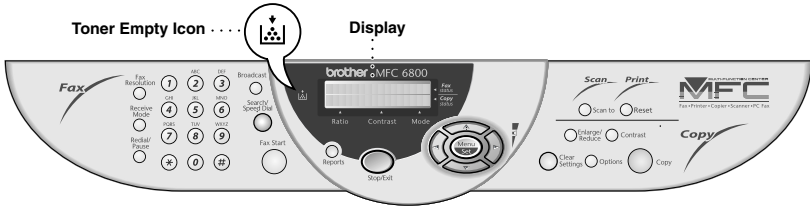

The Toner Empty LED light stays on and the display show **TONER EMPTY** to indicate that the toner is empty. Once this indication appears, the machine will not resume printing until you have installed a new toner cartridge.

### **WARNING**

Just after you have used the MFC, some internal parts of the MFC will be extremely **HOT!** So, please be careful.

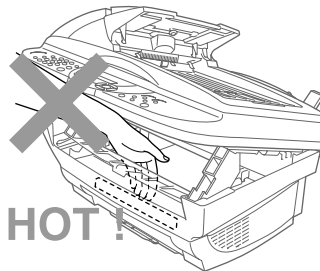

- 1 Open the top cover by pulling the lever toward you and lifting the cover. Make sure the top cover is completely open. To remove the drum unit, hold each side of the drum by its handles and gently lift the drum forward toward you.

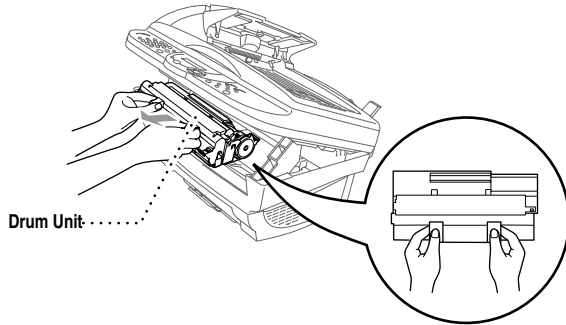
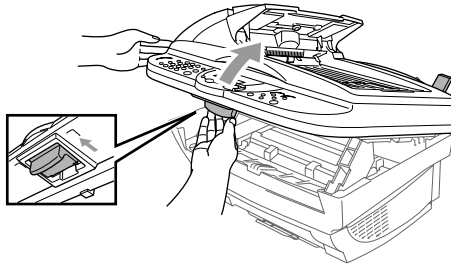

Place the drum unit on a drop cloth or large piece of disposable paper to avoid spilling and scattering the toner.

- 2 Gently turn the lever on the toner cartridge counterclockwise until it stops. The toner cartridge cannot be removed unless the shutter is closed, by turning the lever completely to the front.

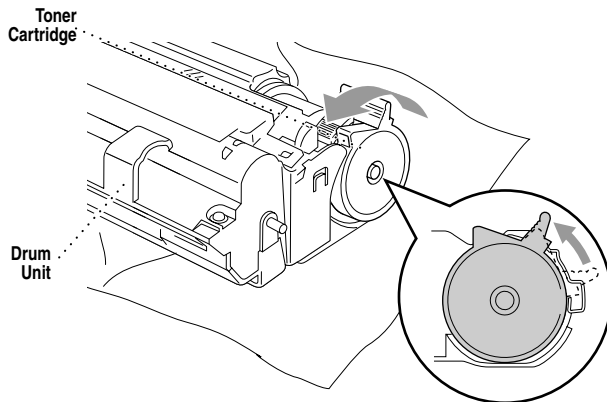



- 3 Remove the used toner cartridge from the drum unit by gently pulling it out.

**Note** Handle the toner cartridge carefully. If toner scatters on your hands or clothes, immediately wipe it off or wash it with cold water.

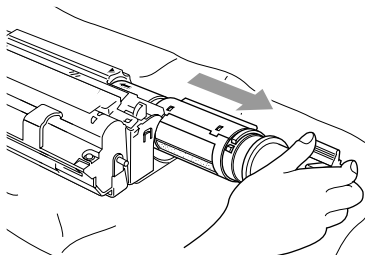

- 4 Unpack the new toner cartridge. Place the used toner cartridge into the aluminum bag and discard it according to local regulations.

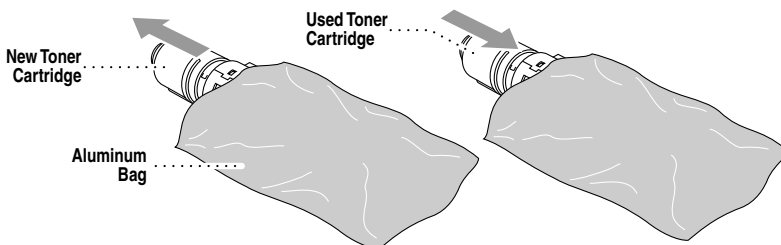

### **!** Caution

- Wait to unpack the toner cartridge until immediately before you install it into the MFC. If a toner cartridge is left unpacked for a long period of time, the toner life is shortened.
- You can use only a genuine Brother toner cartridge (TN-250 series), which is specially formulated to ensure top print quality. Using another brand of toner cartridge may void your MFC's warranty.

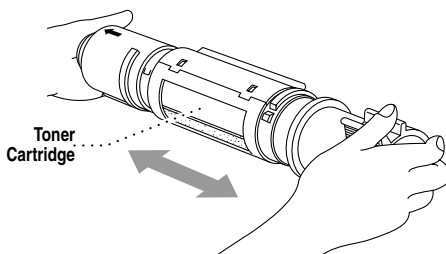

- 5 Gently rock the toner cartridge from side to side five or six times, and then remove the protective seal.

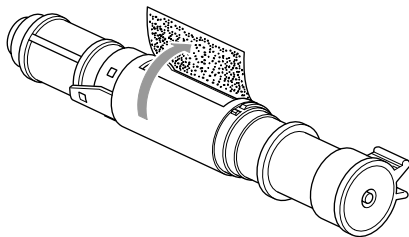

- 6 Slide the new toner cartridge into the opening on the right side of the drum unit. To ensure that the toner cartridge and the drum unit fit together correctly, make sure that the toner cartridge guide arrow is exactly aligned with the guide arrow on the drum unit.

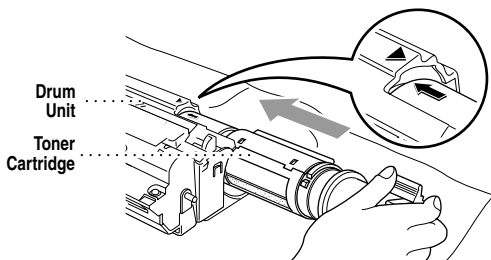

- 7 Gently turn the lever on the toner cartridge clockwise until it stops.

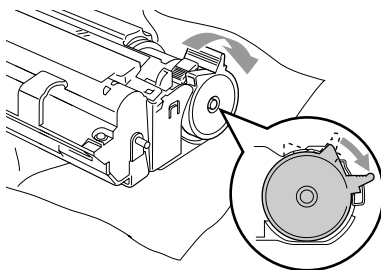

- 8 Reinstall the drum unit in the MFC and close the top cover.

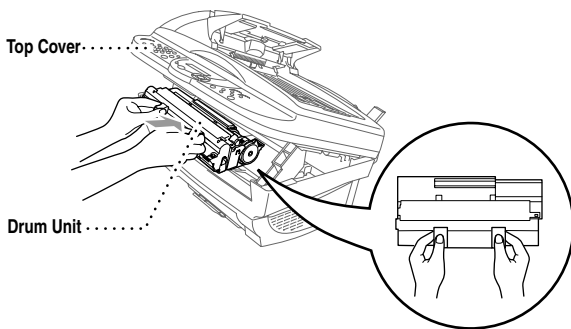

## Replacing the Drum Unit

The MFC uses a drum unit to create the print images on paper. If the LCD shows **CHANGE DRUM SOON**, the drum unit is near the end of its life. Purchase a new drum unit to replace the current one.

Even if the LCD shows **CHANGE DRUM SOON**, you may be able to continue to print without replacing the drum unit for a while. However, if there is a noticeable deterioration in the output print quality even before **CHANGE DRUM SOON** is shown, then the drum unit should be replaced. You should clean the MFC when you replace the drum unit.

### ! Caution

- When removing the drum unit, handle it carefully because it contains toner. When you replace the drum unit, you should clean the MFC.
- Wait to unpack the drum unit until immediately before installing it into the MFC. If an unpacked drum unit is subjected to excessive direct sunlight or room light, the unit may be damaged.
- Handle the toner cartridge and the drum unit carefully because they contain toner. If toner scatters and your hands or clothes get dirty, immediately wipe or wash with cold water.



The drum unit is a consumable item, and it is necessary to replace it periodically. There are many factors that determine the actual drum life, such as temperature, humidity, type of paper and toner that you use and the number of pages per print job, etc. The drum life is estimated at approximately 20,000 pages at 20 pages per job and 8,000 pages at 1 page per job. The actual number of pages your drum will print may be significantly less than these estimates. Because we have no control over the many factors that determine the actual drum life, we cannot guarantee a minimum number of pages that will be printed by your drum.

For best performance, use only a genuine Brother toner cartridge. The product should be used only in a clean, dust-free environment with adequate ventilation.

### ! WARNING

Just after you have used the MFC, some internal parts of the machine are extremely **HOT!** So please be careful.

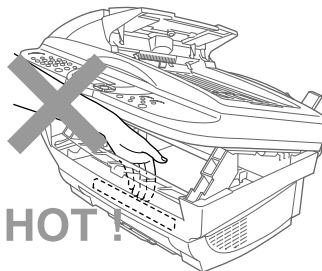

Follow these steps to replace the drum unit:

- 1 Open the top cover.
- 2 Remove the used drum unit. Place the drum unit on a drop cloth or large piece of disposable paper to avoid spilling and scattering the toner.

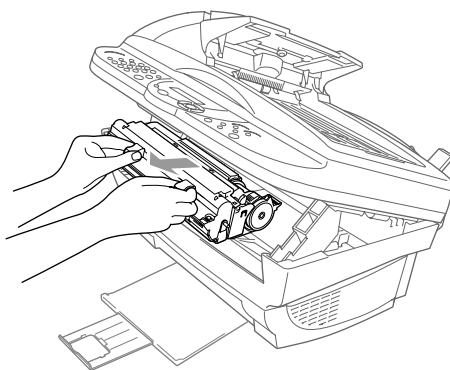

- 3 Remove the toner cartridge from the drum unit and keep it in a safe place. For more information, see *Replacing the Toner Cartridge*, page 20-19.

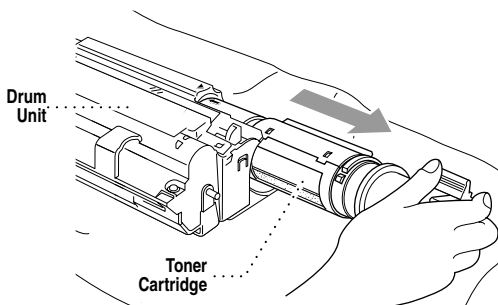

- 4 Place the used drum unit into the aluminum bag and discard it according to local regulations.

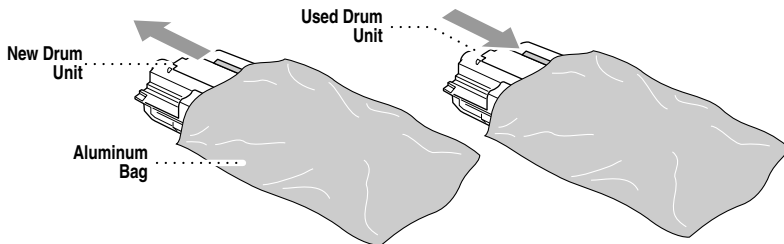

**Note** Discard the used drum unit according to local regulations. If you are not sure of them, call your local Sanitation Department. Be sure to seal the drum unit tightly so toner powder does not spill out of the unit. When discarding used drum units, keep them separate from domestic garbage.

**Caution**

**Do NOT remove the clear plastic starter sheet!**

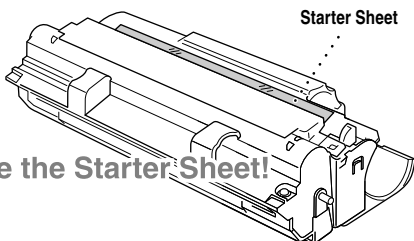

- 5 Reinstall the toner cartridge into the new drum unit. For more information, see *Replacing the Toner Cartridge*, page 20-19.

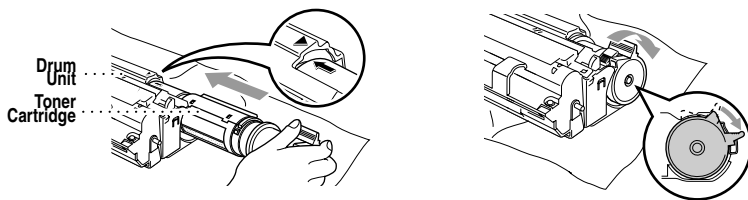

- 6 Holding the new drum unit by its handles, install it. Close the top cover.
- 7 The MFC will eject the clear plastic starter sheet automatically.

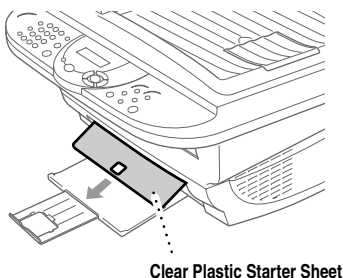

**Caution**

- Do not touch the scanner window with your finger.
- Handle the toner cartridge and drum unit carefully because they contain toner. If toner scatters and your hands or clothes get dirty, immediately wipe or wash it off with cold water.

# Glossary

---

- ADF (Automatic Document Feeder)** Refers to the number of pages that can be placed in the document feeder and fed one at a time automatically.
- Auto Dial List** A listing of names and numbers stored in Speed Dial memory, in numerical order.
- Automatic E-Mail Printing** Software application that automatically prints incoming E-mail messages on the MFC (Instructions are on the CD-ROM).
- automatic fax transmission** Sending a fax without picking up the handset of an external phone.
- Automatic Redial** If the fax did not go through because the line was busy, the MFC redials the number.
- Backup Print** Sets your MFC to print a copy of every fax that is received and stored in memory. This is a safety feature so you will not lose messages during a power failure.
- beeper** The sound the keys make when they are pressed, an error occurs or a document has been received or transmitted.
- beeper volume** Volume setting for the beep when you press a key or make an error.
- Broadcasting** The ability to send the same fax message to more than one location.
- Caller ID** A service purchased from the telephone company that lets you see the number (or name) of the party calling you.
- Cancel Job** You can cancel a programmed job, like Delayed Fax or Polling.
- CNG tones** The special tones (beeps) sent by fax machines during automatic transmission to tell the receiving machine that a fax machine is calling.
- communication error (or Comm. Error)** An error during fax sending or receiving, usually caused by line noise or static.
- Coding Method** Method of coding the information contained in an original. All fax machines must use a minimum standard of Modified Huffman (MH). Your fax machine is capable of greater compression methods, Modified Read (MR) and Modified Modified Read (MMR), if the receiving machine has the same capability.
- Compatibility Group** The ability of one fax unit to communicate with another. Compatibility is assured between ITU-T Groups.
- Contrast** A setting that compensates for dark or light originals, by lightening dark documents or darkening light documents.
- Cover Page** Prints a page at the other party's machine that contains the sender and recipient's name and fax number, number of pages and comment. You can generate an electronic cover page at the other end with pre-programmed information from memory, or you can print a sample cover page to fax with your document.
- Cover Page Message** The comment that is on the Cover Page. This is a programmable feature.
- Delayed Fax** Sends your fax at a later time that day.
- Delayed Timer** You can program a certain time each day that all delayed faxes will be sent on a first-come first-served basis.

**Distinctive Ring** A service purchased from the telephone company that provides another phone number on an existing phone line. The Brother MFC uses the new number to simulate a dedicated fax line.

**drum unit** A printing device for your fax machine.

**Dual Access** Your MFC can scan outgoing faxes or scheduled jobs into memory at the same time it is sending a fax or receiving or printing an incoming fax.

**Easy Receive** Enables your MFC to respond to CNG tones if you interrupt a fax call by answering it.

**ECM (Error Correction Mode)** Detects errors during fax transmission and resends the page(s) that had an error.

**Electronic Cover Page** A preprogrammed cover page that is transmitted from the MFC's memory, eliminating the need for making up cover pages manually.

**extension phone** A telephone on the fax number that is plugged into a separate wall jack.

**external phone** A TAD (telephone answering device) or telephone that is plugged into the EXT jack of your MFC.

**Fax Activity Report** Lists information about the last 50 incoming and outgoing faxes. TX means Transmit. RX means Receive.

**Fax Forwarding** Sends a fax received in memory to another preprogrammed fax number.

**Fax Storage** You can print stored faxes later, or retrieve them from another location using Fax Forwarding, Paging, or Remote Retrieval functions.

**fax tones** The signals sent by sending and receiving fax machines while communicating information.

**Fine mode** Resolution is 196 × 203 dpi. It is used for small print and graphs.

**gray scale** The shades of gray available for copying and faxing photographs.

**Group number** A combination of Speed Dial numbers that are stored on a Speed Dial location for Broadcasting.

**Interval** The preprogrammed time period between automatically printed Fax Activity Reports. You can print Fax Activity Reports on demand without interrupting this cycle.

**LCD (liquid crystal display)** The display screen on the MFC that shows interactive messages during On-Screen Programming and defaults to the date and time when the machine is idle.

**manual fax** When you lift the handset of the external phone so you can hear the receiving fax machine answer before you press **Fax Start** to begin transmission.

**Menu mode** The programming mode for changing the settings of your MFC.



- Multi-Function Link® Pro Suite Software application** Turns your MFC into a printer and a scanner and enables PC faxing using the MFC.
- Next Fax Reservation** Accepts the next document in the document feeder for transmission while the Memory is full.
- Out of Paper Reception** Receives faxes into the MFC's memory when the machine is out of paper.
- Overseas mode** Makes temporary changes to the fax tones to accommodate noise and static on overseas phone lines.
- Paging** Feature enables your MFC to call your pager when a fax is received into its memory.
- Pause** Allows you to place a 3.5 second delay in the dialing sequence stored on Speed Dial numbers.
- Photo mode** A resolution setting that uses varying shades of gray for the best representation of photographs.
- Polling** The process of a fax machine calling another fax machine to retrieve waiting fax messages.
- printer alarm** Audible alarm when the printer is not able to print.
- Pulse (For Canada only)** A form of rotary dialing on a telephone line.
- Real Time Transmission** When memory is full, you can send documents in real time.
- Reduction** reduces the size of incoming faxes.
- Remaining jobs** You can check which jobs are waiting in memory and cancel jobs individually.
- Remote Activation** allows you to transfer a fax call, answered at an extension phone, to the MFC.
- Remote Retrieval Access Code** The four-digit code (159✳) that allows you to call and access your MFC from a remote location.
- Resolution** The number of vertical and horizontal lines per inch. See: Standard, Fine, Super Fine and Photo.
- Ring Delay** The number of rings before the MFC answers in FAX ONLY mode.
- Ring Volume** Volume setting for the MFC's ring.
- scanning** The process of sending an electronic image of an original paper document into your computer.
- ScanSoft™ PaperPort® LE for Brother** A document management application that enables you to view scanned documents.
- Speed Dial** A preprogrammed number for easy dialing. You must press the **Search/Speed Dial** button and then #, two digit code (and **Fax Start**) to start the dialing process.
- Standard resolution** 98 × 203 dpi. It is used for regular size text and quickest transmission.
- Station ID** The stored information that appears on the top of faxed pages. It includes the sender's name and fax number.
- Super Fine resolution** 392 × 203 dpi. Best for very small print and line art.
- TAD (telephone answering device)** You can connect an *external* TAD to the EXT. jack of the MFC for EXT. TEL/TAD mode.

**temporary settings** You can select certain options for each copy and fax transmission without changing the default settings.

**toner cartridge** An accessory that holds toner for the drum unit on Brother laser models.

**Toner Save** A process that causes less toner to be affixed to the page to extend the life of the toner cartridge. This will make the print on received documents significantly lighter.

**transmission** The process of sending documents over the phone lines from your MFC to the receiving fax machine.

**Transmission Verification Report** A listing of each transmission, date, time and number of pages.

**User Settings** A printed report that shows the current settings of your MFC.

# Specifications

---

## Product Description

Five performance modes are available for the 5 in 1 model MFC-6800:  
Fax, Printer, Copier, Scanner and PC Fax.

## Fax

<b>Coding System</b>	MH/MR/MMR:
<b>Modem Speed</b>	14400-2400 bps; Automatic Fallback:
<b>Document Size</b>	ADF Width: 5.8" to 8.5" (148 mm to 216 mm) ADF Length: 5.8" to 14.0" (148 mm to 356 mm) Scanner Width: Max. 8.5" (216 mm) Scanner Length: Max. 11.7" (297 mm)
<b>Scanning/Printing Width</b>	8.2 inches (208 mm)
<b>Paper Size</b>	Letter/Legal/A4
<b>Automatic Document Feeder (ADF)</b>	Up to 30 sheets (20 lbs)
<b>Multi-purpose Paper Cassette</b>	200 sheets (20 lbs)
<b>Gray Scale</b>	64 levels
<b>Polling Types</b>	Standard or Sequential
<b>Contrast Control</b>	Automatic/Super Light/Super Dark (manual setting)
<b>Resolution</b>	<ul style="list-style-type: none"><li>• Horizontal 203 dot/inch (8 dot/mm)</li><li>• Vertical Standard—98 line/inch (3.85 line/mm) Fine, Photo—196 line/inch (7.7 line/mm) Superfine, Photo—392 line/inch (15.4 line/mm)</li></ul>
<b>Out of Paper Reception</b>	Up to 500 pages* in memory
<b>Speed Dial</b>	100 stations
<b>Automatic Redial</b>	3 times at 5 minute intervals
<b>Speaker Type</b>	Monitor
<b>Auto Answer</b>	0, 1, 2, 3, 4 or 5 rings
<b>Communication Source</b>	Public switched telephone network

# Printer

## Printer Driver

Windows® 95/98/98SE/Me/2000 Professional and Windows NT® Workstation Version 4.0 driver supporting Brother Native Compression mode and bi-directional capability

Apple® Macintosh® QuickDraw® Driver for OS 8.5/8.51/8.6/9.0/9.0.4/9.1

## Interface

Bi-directional parallel (IEEE 1284);  
USB (Universal Serial Bus) Interface

## Memory Capacity

8 MB

## Print Method

Electrophotography by semiconductor laser beam scanning

## Resolution

600 dots/inch

## Print Quality

Normal printing mode  
Economy printing mode

## Print Speed

Up to 10 pages/minute (when loading letter size or A4 paper from multi-purpose sheet feeder)

## Consumable Items

Toner cartridge Life Expectancy:  
Up to 2,200 pages/*new* toner cartridges  
Up to 1,000 pages/*starter* toner cartridges  
(USA, Canada and some other areas only)  
(when printing letter size or A4 paper at 5% print coverage)



Toner life expectancy will vary depending upon the type of average print job.

Drum Unit Life Expectancy:

Up to 20,000 pages at 20 pages per job

Up to 8,000 pages at 1 page per job



There are many factors that determine the actual drum life (such as the temperature, humidity, type of paper, toner you use and number of pages per print job).

Drum life will be longer in print and copy modes compared to fax mode.

- \* “Pages” refers to the “Brother Standard Chart No. 1” with MMR cording and standard resolution. Specifications and printed materials are subject to change without prior notice.

## True Type Fonts on CD-ROM

TrueType compatible soft-fonts for Windows® on the on bundled CD-ROM

# Computer Requirements

Minimum System Requirements					
Computer Platform & Operating System Version		Processor Minimum Speed	Minimum RAM	Recommended RAM	Available Hard Disk Space
Windows® Operating Systems	95, 98, 98SE	Pentium 75MHz	24MB	32MB	50MB
	Me	Pentium 150MHz	32MB	64MB	
	NT® Workstation 4.0	Pentium 75MHz			
	2000 Professional	Pentium 133MHz	64MB	128MB	
	XP	Pentium 233MHz			
Apple iMac™/iBook™/G3/G4 Operating Systems	OS 8.5 – 8.51 (Printing Only)	All base models meet minimum requirements			50MB
	OS 8.6 – 9.2 (Printing and Scanning)				
	Mac OS X v.10/10.1 (Printing Only) †				
<b>NOTE:</b> USB is not supported under Windows® 95 or Windows NT® 4.0 All registered trademarks referenced herein are the property of their respective companies. † Printer Driver can be downloaded from <a href="http://solutions.brother.com">http://solutions.brother.com</a>					

# Electrical and Environment

<b>Temperature</b>	Operating 50 - 90.5° F (10 - 32.5° C) Storage 32 - 104° F (0 - 40° C)
<b>Warm-Up</b>	Approx. 12 seconds at 73.4° F (23° C)
<b>First Print</b>	15 seconds (using Letter size paper in multi-purpose sheet feeder)
<b>Power Source</b>	120V AC 50/60Hz (USA, Canadian Version Only)
<b>Power Consumption</b>	Average Operating (Copying) 260 W (25° C) Peak: 940 W Sleep Mode: 15 W or less Stand by: 75 W or less (25° C)
<b>Noise</b>	Operating: 52 dB A or less Stand by: 39 dB A or less
<b>Humidity</b>	Operating: 35 to 80% (without condensation) Storage: 10 to 90% (without condensation)
<b>Dimensions</b>	18.1 × 18 × 13.9 inches/(459 × 458 × 354 mm)
<b>Weight</b>	24.2 lbs/(11 kg) (Without Carton)

## Parallel Interface

Interface Connector                      Printer Side:    Amphenol FCN-685J036-L/X or equivalent  
 A shielded cable should be used.

### Pin Assignment

Pin No.	Signal	Direction	Pin No.	Signal	Direction
1	DATA STROBE	Input	19	0V(S.G.)	-
2	DATA 1	Input	20	0V(S.G.)	-
3	DATA 2	Input	21	0V(S.G.)	-
4	DATA 3	Input	22	0V(S.G.)	-
5	DATA 4	Input	23	0V(S.G.)	-
6	DATA 5	Input	24	0V(S.G.)	-
7	DATA 6	Input	25	0V(S.G.)	-
8	DATA 7	Input	26	0V(S.G.)	-
9	DATA 8	Input	27	0V(S.G.)	-
10	<u>ACKNLG</u>	Output	28	0V(S.G.)	-
11	BUSY	Output	29	0V(S.G.)	-
12	PE	Output	30	0V(S.G.)	-
13	SLCT	Output	31	<u>INPUT PRIME</u>	Input
14	<u>AUTO FEED</u>	Input	32	<u>FAULT</u>	Output
15	N.C.	-	33	N.C.	-
16	0V (S.G.)	-	34	N.C.	-
17	0V (S.G.)	-	35	N.C.	-
18	+5V	-	36	<u>SLCT IN</u>	Input

## USB (Universal Serial Bus) Interface

### Pin Assignment

Pin No.	Signal	
1	Vol (+5V)	
2	- Data	Serial Data -
3	+ Data	Serial Data +
4	Ground	

# Index

---

## A

- access codes, for dialing, storing 7-4
- accessories and supplies ii
- ADF (Automatic Document Feeder) 6-1
- assembly
  - drum unit assembly 2-3
  - grounded 3-prong plug 2-5
  - loading paper 2-7
  - power code 2-5
  - telephone line cord 2-5
  - toner cartridge 2-3
- automatic
  - dialing 7-3
  - fax receive 5-1
  - transmission 6-4

## B

- Bi-directional Parallel Cable 2-1
- Brightness 1-3
- Broadcasting 7-5
  - setting up Groups for 7-2
- Brother
  - accessories and supplies ii
  - Brother numbers i
  - Customer Service i
  - fax-back system i
  - Frequently Asked Questions (FAQs) i
  - test sheet, sending 1-2
  - warranties iii to iv
- Brother Control Center
  - using and configuring 14-1 to 14-16

## C

- CALL PICKUP 8-3
- Caller ID 8-3, 8-4
- Canceling
  - Fax Forwarding 9-4
  - fax jobs in memory 5-6
  - jobs awaiting redial 6-6

- Paging 9-4
  - scheduled job 5-6
- cleaning
  - drum unit 20-19
  - printer 20-18
  - scanner 20-17
- control panel 1-3
- copy
  - contrast 11-9
  - default setting 11-8
  - keys 11-3
  - resolution 1-3
- copy(ies)
  - enlarging 11-4
  - multiple 11-1
  - photographs 11-5, 11-9
  - quality 20-12
  - reducing 11-4
  - scannable area 11-1
  - single 11-1
  - temporary settings 11-3
- corrections 4-3
- cover page 4-2, 6-8, 6-9, 6-10
  - composing 6-8
  - custom comments 6-8
  - for all faxes 6-9
  - for next fax only 6-9
  - printed form 6-10
- credit card numbers 7-4
  - dialing 7-4
  - storing 7-4
- custom telephone features 2-13
- Customer Service i

## D

- Date and Time, setting 4-1
- Delayed Batch Transmission 6-12
- Delayed Fax, sending 6-11
- dialing
  - access codes 7-4

- automatic fax redial 6-4
- Groups 7-5
- pause 7-4
- Pulse (For Canada) 7-4
- Search 7-3
- Speed Dial numbers 7-3
- document size and resolution 6-1
- drivers
  - Macintosh® 18-1
  - Windows®
    - PC-FAX 16-14
    - Printer 12-1, 13-1
- drum unit
  - cleaning 20-19
  - installing 2-3
  - replacing 20-24
- Dual Access 6-4

## E

- Easy Receive 5-3
- ECM (Error Correction Mode) 1-6
- entering text 4-2
- envelopes 2-7
- error messages on LCD 20-1
  - CHECK PAPER 20-1
  - COMM.ERROR 20-1
  - NOT REGISTERED 20-3
  - OUT OF MEMORY 20-3
    - while scanning a document 6-4
- extension telephone, using 5-4
- external telephone answering device (TAD) 1-6, 2-9
- external telephone, connecting 2-8
- external two-line TAD 2-12

## F

- fax codes
  - Fax Receive Code 5-3, 5-4
  - Remote Retrieval Access Code 9-3
  - troubleshooting 5-4
- Fax Forwarding 9-1
  - changing remotely 9-4, 9-5
  - programming a number 9-1

- Fax Redial 6-4
- Fax Storage 9-2
  - printing from 5-5
  - setting 9-2
- fax, stand-alone
  - receiving 5-1
    - erasing from memory 9-2, 9-4
    - forwarding 9-1, 9-4
    - polling 5-5
    - reducing to fit on paper 5-3
    - retrieving from a remote site 9-5
- Ring Delay, setting 5-2
- sending
  - automatic fax redial 6-1
  - automatic transmission 6-4
  - canceling from memory 6-6
  - contrast, setting 6-7
  - cover page 6-8
  - delayed 6-11
  - from memory (dual access) 6-4
  - in real time 6-5
  - manual transmission 6-4
  - overseas 6-10
  - polling 6-12
  - resolution, setting 6-7
- Fixed reduction 5-3

## G

- gray scale S-1
- Groups for Broadcasting, setting up 7-2

## H

- HELP 1-3, 10-2

## I

- iMac 18-1
- improving print quality 20-13, 20-17

## J

- jacks 2-11
  - converting telephone wall outlets 2-11
  - EXT. jack 2-8, 2-9, 2-12



wall jacks 2-11, 2-12

## L

LCD (Liquid Crystal Display) 3-1

## M

Macintosh® G3, G4 or iMac™ 18-1

maintenance, routine 20-17

manual

mode 5-1

transmission 6-4

memory storage 4-4

multi-line connections (PBX) 2-13

multi-purpose sheet feeder capacity 2-8

## O

OCR (ScanSoft™TextBridge®) 15-1

On-Screen Programming 3-1

Options Key 11-5

OUT-OF-AREA 8-3

## P

packing list 2-1

Paging 9-1, 9-2

programming a number 9-1

paper

jam 20-6

size 2-7, 2-8, 4-1

specifications 2-7, 2-8, S-1

type 1-3

PaperPort® for Brother

exporting an image file 15-4

prescanning an image 15-7

scanning into PC

accessing 15-4

settings 15-5

uninstall 15-1

viewing faxes and files 15-2

PBX 2-13

PC FAX (For Macintosh®) 18-3

sending 18-3

address book 18-5

groups, setting up 18-6

PC FAX (For Windows®) 16-3

sending

address book 16-7

cover page 16-12

facsimile style 16-14

group 16-9

setting up 16-3

simple style 16-15

phone line

difficulties 20-10

roll-over 2-11

two-line 2-11

Polling 5-5, 6-12

power

cord 2-5

electrical outlet 2-5

failure 4-4

printing 12-1

difficulties 20-8

PC software settings 12-1

quality 20-13

resolution S-2

specifications S-2

speed S-2

## R

Real Time Transmission 6-5

Receive Mode 5-1

EXT.TEL/TAD 5-1

FAX ONLY 5-1

MANUAL 5-1

Redial/Pause 1-3, 6-4, 7-4

reducing

copies 11-4

long faxes 5-3

Remote Retrieval 9-3

access code 9-2

changing 9-3

using 9-3

commands 9-4

getting your faxes 9-5

reports 10-1

resolution  
fax (standard, Fine, Super Fine, Photo) S-1  
printing S-2  
scanning 15-5  
setting for next fax 6-7

## S

safety instructions 19-5  
Search 7-3  
shipping the machine 20-15  
Sleep mode 4-5  
Software  
using  
    Brother Control Center 14-1  
    ScanSoft™ PaperPort® and  
    TextBridge® OCR 15-1  
special characters 4-3  
Speed Dial 1-3, 7-3  
    changing 7-1  
    dialing 7-3  
    storing 7-1  
Station ID 1-2, 4-2  
    Federal regulation 4-3

## T

TAD (Telephone Answering Device) 1-6,  
2-10, 2-12, 5-1  
    Connecting 2-9  
timer 6-11  
Tone Signals on Pulse Line 7-4  
toner cartridge  
    installing 2-3  
    replacing 20-19  
toner save 4-5  
transparencies 2-7  
triplex adapter 2-11  
troubleshooting 20-1  
    error messages on LCD 20-1  
    if you are having difficulty 20-8  
    incoming calls 20-10  
    phone line connections 20-9  
    printer difficulties 20-11  
    printing or receiving faxes 20-8

    sending faxes 20-9  
    Windows® setup printing 20-12  
machine 20-1  
Two-Line Phone System 2-11, 2-12  
    converting wall jacks 2-11

## V

Volume setting  
    beeper 4-4  
    ring 4-4  
    speaker 4-4

## W

warranties  
    Canada vi  
    disclaimer iii  
    USA iv  
Windows® 12-1  
World Wide Web i

# Remote Retrieval Access Card

If you plan to receive fax messages while away from your machine, carrying the Remote Retrieval Access Card printed below will serve as a convenient reminder of the retrieval procedures. Simply cut out the card and fold it to fit your wallet or organizer. Keeping it handy will help you derive the full benefit of your machine's forwarding, paging and remote retrieval features.

**REMOTE RETRIEVAL ACCESS CARD**

**CHECK RECEIVING STATUS**  
Press **9 7 1**  
1 long beep — Fax message(s)  
3 short beeps — No messages

**CHANGE ANSWER MODE**  
Press **9 8**  
then for EXT.TEL/TAD, press 1.  
FAX ONLY, press 2.

**EXIT REMOTE OPERATION**  
Press **9 0**.

**Using Remote Retrieval Access Code**

- 1 Dial your fax number from a fax machine using touch tone.
- 2 When your MFC answers, immediately enter your Remote Retrieval Access Code (159✳).
- 3 Your MFC signals the kinds of messages received:  
1 long beep — Fax message(s)  
No beeps — No messages.
- 4 After 2 short beeps, enter a command.
- 5 Press **9 0** to reset your MFC when you finish.
- 6 Hang up.

Fold →      ← Fold

1

4

**Changing Remote Retrieval Access Code**

- 1** Press **Menu/Set 2, 5, 3**
- 2** Enter a three-digit number from 000 to 999.  
The \* cannot be changed.
- 3** Press **Menu/Set**.
- 4** Press **Stop/Exit**.

**Remote Commands**

**CHANGE PAGING/FAX FORWARDING SETTING**

- Press **9 5**.  
*then to* Turn Feature off, press **1**.  
Select Fax Forwarding, press **2**.  
Select Paging, press **3**.

**Program Fax Forwarding Number, press 4** Enter the new fax number where you want your fax messages forwarded followed by **##**.

**Turn Fax Storage on, press 6.**  
**Turn Fax Storage off, press 7.**

**RETRIEVE A FAX**

- Press **9 6**  
*then to* Retrieve all faxes, press **2**.  
then enter the number of remote fax machine followed by **##**. After the beep, hang up and wait.  
Erase all fax messages, press **3**.

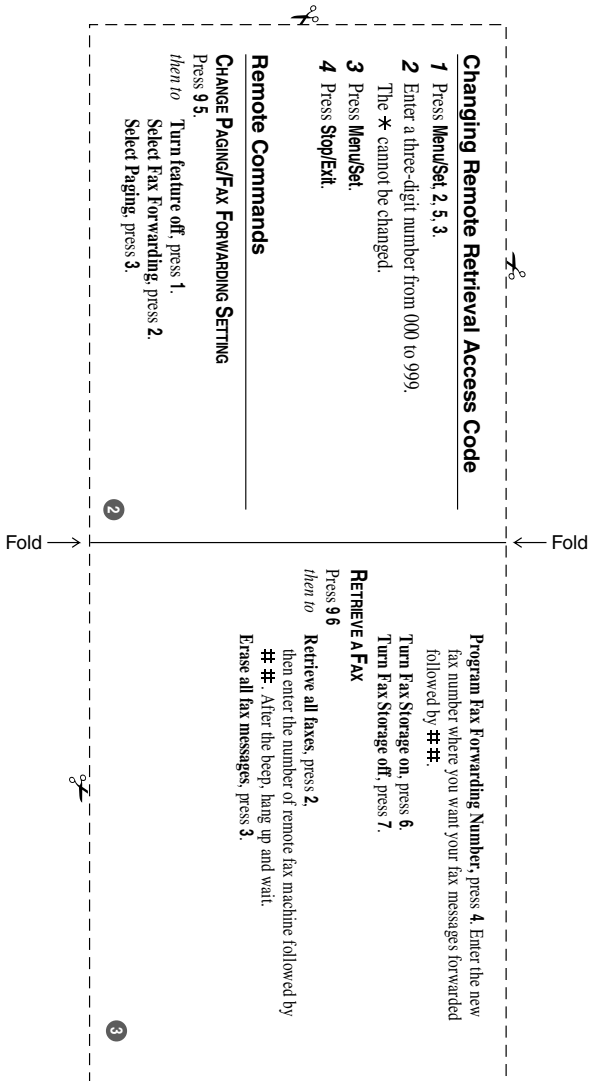

## **EQUIPMENT ATTACHMENT LIMITATIONS (For Canada Only)**

### **NOTICE:**

The industry Canada label identifies certified equipment. This certification means that the equipment meets telecommunications network protective, operational and safety requirements as prescribed in the appropriate Terminal Equipment Technical Requirements document(s). The Department does not guarantee the equipment will operate to the user's satisfaction.

Before installing this equipment, users should ensure that it is permissible to be connected to the facilities of the local telecommunications company. The equipment must also be installed using an acceptable method of connection. The customer should be aware that compliance with the above conditions may not prevent degradation of service in some situations.

Repairs to certified equipment should be coordinated by a representative designated by the supplier. Any repairs or alterations made by the user to this equipment, or equipment malfunctions, may give the telecommunications company cause to request the user to disconnect the equipment.

Users should ensure for their own protection that the electrical ground connections of the power utility, telephone lines and internal metallic water pipe system, if present, are connected together.

This precaution may be particularly important in rural areas.

### **Caution:**

Users should not attempt to make such connections themselves, but should contact the appropriate electric inspection authority, or electrician, as appropriate.

### **NOTICE:**

The Ringer Equivalence Number (REN) assigned to each terminal device provides an indication of the maximum number of terminals allowed to be connected to a telephone interface. The termination on an interface may consist of any combination of devices subject only to the requirement that the sum of the Ringer Equivalence Numbers of all the devices does not exceed 5 REN=0.3

# brother®

Brother International Corporation  
100 Somerset Corporate Boulevard  
P.O. Box 6911  
Bridgewater, NJ 08807-0911 USA

Brother International Corporation (Canada) Ltd.  
1 rue Hôtel de Ville,  
Dollard-des-Ormeaux, QC, CANADA H9B 3H6

**Visit us on the World Wide Web**  
**<http://www.brother.com>**

These machines are made for use in the USA and CANADA only. We cannot recommend using them overseas because it may violate the Telecommunications Regulations of that country and the power requirements of your fax machine or multi-function center may not be compatible with the power available in foreign countries. **Using USA or CANADA models overseas is at your own risk and will void your warranty.**

## Free Manuals Download Website

<http://myh66.com>

<http://usermanuals.us>

<http://www.somanuals.com>

<http://www.4manuals.cc>

<http://www.manual-lib.com>

<http://www.404manual.com>

<http://www.luxmanual.com>

<http://aubethermostatmanual.com>

Golf course search by state

<http://golfingnear.com>

Email search by domain

<http://emailbydomain.com>

Auto manuals search

<http://auto.somanuals.com>

TV manuals search

<http://tv.somanuals.com>