



Logixx 1400 Express

en Instruction Manual and
Installation Instructions



Household Appliances

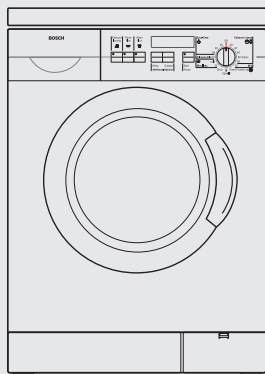

Internet: <http://www.bosch-hausgeraete.de>

BOSCH

Table of Contents

Operating Instructions

Disposal Information	6
Disposing of the packaging	6
Disposing of your old appliance	6
Environmental Protection / Conservation Issues .	7
General Safety Instructions	8
Your New Washing Machine	9
Control panel	10
Before Using Your Washing Machine For the First Time	11
Preparing your washing machine	11
Selecting the language	12
Preparing, sorting and loading the washing	13
Preparing the laundry	13
Sorting the laundry	14
Degrees of dirt	14
Loading the laundry	17
Laundry Detergents and Additives	18
Dispensing the correct amount of detergent .	18
Filling laundry detergent and/or additive dispensers	19
Programmes and functions	20
Washing with standard settings	28
Washing with individual settings	30
Quick overview	30
Spin speed	31
Programme finished at	32
Prewash	34
Signal	35
Child lock	36
Winter time/ Summer time	38
Set clock	39
Resetting the settings	41

During washing	42
Reselecting a programme	42
Topping up the washing/ Interrupting the programme	42
Cancelling active programme	44
After washing	45
“Without final spin” preselected	45
“Child lock: ON” preselected	46
Emergency lock release	47
Special Applications	48
Pre-soak	48
Starching	48
Dyeing	49
Decolorizing	49
Cleaning and Care	50
Cleaning the appliance housing and control panel	50
Cleaning the drum	50
Cleaning the detergent dispenser	51
Cleaning the drain pump	52
Cleaning water inlet strainers	53
Descaling the washing machine	54
Troubleshooting Minor Faults	55
Fault displays	60
Consumption Rates	61
Customer service	62
Installation, Connection and Transport	63
Safety instructions	63
Supplied accessories	64
Dimensions	65
Installation area	65
Built-under or built-in appliance installation	66
Removing the transport bolts	67
Before removing the transport bolts	67
Removing the transport bolts	67
Storing the transport bolts	68
Hose and cable lengths	69
Water connection	70

Installation Instructions

Levelling procedure	72
Electrical connection	73
Transport, e.g. when moving	74
Additional guarantee	75

The new washing machine which you have just purchased is a modern, high-quality domestic appliance.

Your washing appliance is distinguished by its economical consumption of power, water and detergent.

Each washing machine which leaves our factory has undergone a thorough performance test and is in fully working order. If you have any queries – especially concerning installation of the washing machine – our customer service will be happy to advise you.

Further information and a selection of our products can be found on our Internet page:
<http://www.bosch-hausgeraete.de>

Please read and observe these operating and installation instructions and all other information enclosed with the washing machine.

Keep all documentation in a safe place for subsequent use or for the next owner of the appliance.

Disposal Information

Disposing of the packaging

The shipping package has protected your new appliance on its way to your home. All packaging materials are environment-friendly and recyclable. Please contribute to a better environment by disposing of packaging materials in an environmentally conscious manner.

Please ask your dealer or local authority about best means of disposal.

⚠ Danger of suffocation!

Keep children away from shipping carton and packaging components. Danger of suffocation from folding cartons and plastic film.

Disposing of your old appliance

Old appliances are not worthless rubbish! Environment-conscious recycling can reclaim valuable raw materials.

⚠ Danger of fatal injury!

On out-of service appliances, unplug mains plug. Cut off power cord and discard with mains plug.

Cut off power cord and discard with mains plug. To prevent playing children from becoming trapped and endangered, ensure that the door locking mechanism is disabled.

Environmental Protection / Conservation Issues

Your washing machine uses water, energy and detergent efficiently, thereby protecting the environment and reducing your household costs. See Page 61 for consumption values of your appliance.

Hints and tips

Using your washing machine in an efficient and environmentally friendly manner:

- Do not exceed recommended load.

Cottons+Linens	6 kg
Easy-Care	3 kg
Delicates and Silk	2 kg
Woollens	2 kg
- Where possible, use the 60 °C “Stains” programme instead of the 90 °C “Cottons+Linens” programme. The extended washing time achieves a cleaning result comparable to that of the 90 °C programme, but uses considerably less energy.
- Do not use prewash for lightly to normally soiled washing.
- Add detergent according to the degree of soiling, amount of laundry and water hardness, and observe the detergent manufacturer’s instructions.
- If washing is then to be dried in the tumble dryer, select spin speed in accordance with the instructions supplied by the dryer manufacturer.

General Safety Instructions

Your washing machine is intended:

- For domestic use only.
- For washing machine-washable fabrics in washing lye.
- For operation with cold drinking water and commercially available detergents and cleaning products which are suitable for use in washing machines.

Do not leave children unsupervised near the washing machine.

Keep pets away from the washing machine.

Do not insert/pull out the mains plug with wet hands.

Do not pull out the mains plug by tugging the cable.

Do not touch the loading door when washing at high temperatures.

Take care when draining hot washing lye.

Do not climb on the washing machine.

Do not lean on the open loading door.

Pull the emergency lock release only when:

- the programme selector has been turned to "Off"
- the drum is at a standstill and
- you have drained the detergent solution.

Your New Washing Machine

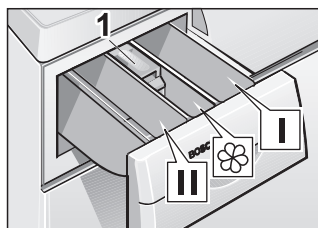

Filling laundry detergent and/or additive dispensers

Dispenser I:

Detergent for prewash or starch.

Dispenser II:

Detergent for main wash, water softener, pre-soaking agent, bleach and stain removal product.

Dispenser ☼:

Additives, e.g. fabric softener or former.

(Fill no higher than lower edge of insert 1).

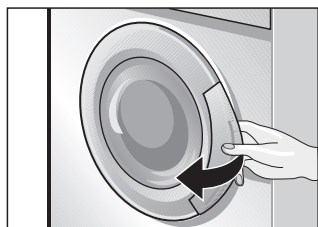

Opening ...

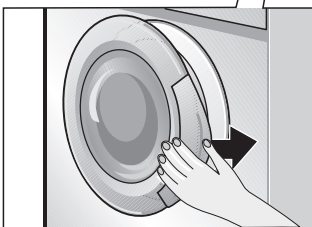

and closing the door

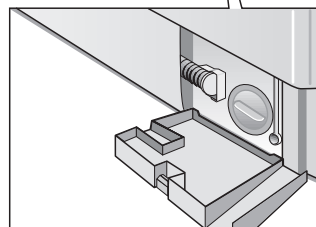

Service flap

Control panel

Buttons for additional options

(in addition to the programme if required)

“Reduced Ironing”: Gentle spin

“Rinse Plus”: Extra rinse cycle

“Wash Plus”: Intensive wash

Additional option selected:

Indicator light is glowing red.

Preselected additional options are retained for the next wash.

Switch off additional option:

Press button again.

Indicator light goes out.

Display field

Indicates the settings which have been selected or which are to be changed (e.g. spin speed, end time, prewash and childproof lock) as well as programme progress.

Programme selector with indicator light

For switching the machine on and off and for selecting the programme.

Can be rotated in either direction.

The programme selector does not rotate while the programme is running – the programme sequence is electronically controlled.

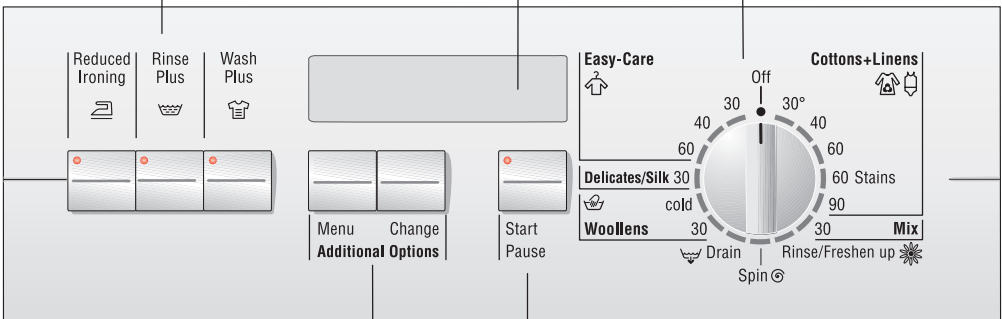

“Menu” button

For selecting settings which are to be changed.

“Change” button

For changing all the settings in the display field.

“Start/Pause” button

For starting or interrupting the wash cycle (programme must have been selected).

Indicator light

Indicator light flashes red:

Settings can be changed or the wash cycle can be started.

Indicator light is glowing red:

Programme is running.

Top-up possible.

The indicator light is on (yellow):

The door is locked for reasons of safety or the childproof lock is active.

Before Using Your Washing Machine For the First Time

Preparing your washing machine

Caution

The washing machine must have been installed and connected properly (refer to Page 63).

Your appliance was tested before leaving the factory. To remove any water left over from testing procedures, the first washing cycle should be carried out without laundry in the machine.

- Do not load any laundry.
- Turn on water tap.
- Pull out the detergent dispenser up to the end stop.
- Pour approx. 1 litre / 1 $\frac{3}{4}$ pt of water into chamber **II** of the detergent dispenser.
- Half fill the measuring beaker with detergent and pour into chamber **II**.
- i** Do not use any special detergents for delicates or woollens (excessive foam).
- Close the detergent dispenser.
- Close the loading door.
- Set the programme selector to “60 °C Easy-Care”. The “Start/Pause” indicator light flashes (red).
- Press the “Start/Pause” button. The programme starts. The indicator light is on (red).
- i** The individual programme steps are indicated in the display field.

When “Remove washing” is displayed:

- Turn the programme selector to “Off”.

Selecting the language



Text in the display field can be displayed in a language other than the preselected language.

- i** The programme selector must not be set to “Off”.
- i** The language must be selected before a programme is started.
- Simultaneously press the “Menu” and “Change” buttons and hold down (5 seconds) until the current setting is displayed.
- Press the “Change” button until the required language – e.g. “English” – is displayed.
- Confirm the language selection by pressing the “Menu” button.
- i** The selected setting is retained after the wash cycle.

Preparing, sorting and loading the washing

Preparing the laundry

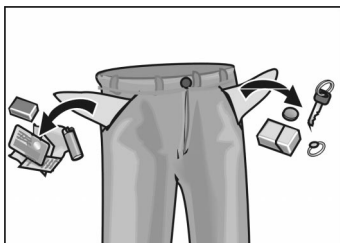

Caution

Loose debris (e.g. coins, paper clips, needles, nails) can damage items of clothing as well as parts of the washing machine (e.g. drum).

- Empty all pockets on items of clothing.
- Brush out any sand from pockets and cuffs.
- Close zip-fasteners and button up bed covers.
- Remove curtain runners or tie them up in a net / bag.
- The following items must be washed inside a net / pillow case:
 - Extremely delicate items, e.g. fine tights, net curtains.
 - Small items, e.g. small socks or handkerchiefs.
 - Underwired bras (the wire may come loose during washing and cause damage).
- When washing trousers, knitwear and woven fabrics, e.g. shirts, T-shirts or sweatshirts, always turn these items inside out.

Sorting the laundry

According to colour and degree of dirt

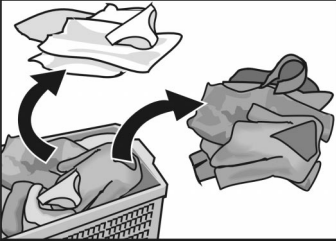

Degrees of dirt

Caution

Items of clothing can become discoloured. Never wash new multi-coloured items together with other items.

White items may become grey. Always wash white and coloured items separately.

Slight dirt

No recognizable dirt or staining. Laundry may have some body odour.

- Light summer clothing and sportswear that has only been worn for a few hours.
- T-shirts, shirts and blouses that have been worn for up to one day.
- Bed linen and guest towels that have been used for one day.

Normal dirt

Visible dirt and/or some light staining recognizable.

- T-shirts, shirts and blouses that are very sweaty or have been worn several times.
- Underwear that has been worn for one day.
- Tea towels, hand towels and bed linen that have been used for up to one week.
- Net curtains (without nicotine staining) that have not been washed for up to ½ year.

Intensive dirt

Dirt and/or staining recognizable.

- Kitchen hand towels that have been used for up to one week.
- Fabric napkins.
- Bibs.
- Children's outer clothing or football shirts and shorts with grass and soil stains.
- Working clothes such as overalls or baker's and butcher's coats.

Typical stains

- Skin fat, cooking oils / fat, sauces, mineral oil, wax (containing fat / oil).
- Tea, coffee, red wine, fruit, vegetables (bleachable).
- Blood, egg, milk, starch (containing protein / carbohydrate).
- Soot, soil, sand (pigments), red sand on tennis clothes.

Removing stains

Wherever possible, remove / pretreat stains whilst they are still fresh.

First, dab soapy water onto the stain. Do not rub.

Subsequently wash the items of clothing using the appropriate programme.

Several washing cycles may sometimes be required in order to remove stubborn / dried in stains.

Sorting laundry according to their care label specifications

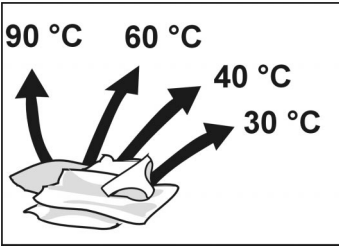

90 °C Cottons+Linens



30, 40, 60 °C Cottons+Linens



30, 40, 60 °C Easy-Care



30 °C Delicates/Silk



Hand and machine-washable woollens cold, 30 °C

Laundry that is labelled with the following care symbol must not be washed in the washing machine:



= do not wash

Loading the laundry

⚠ Risk of explosion!

Items of clothing that have been pretreated with solvent-based cleaning agents, e.g. stain remover and dry cleaning spirit, represent an explosion hazard once loaded into the washing machine. Therefore, these items must first be rinsed thoroughly by hand.

Caution

Loose debris in the washing machine drum can damage the laundry. Before loading the laundry, check that there is no debris in the drum.



- Open the loading door.

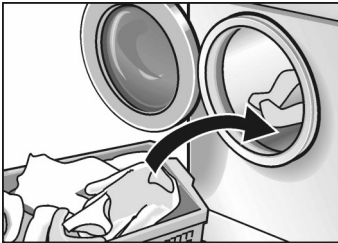

- Unfold the sorted items of clothing and place them loosely into the drum. Mix large and small items. Laundry items which vary in size are more evenly distributed during the spin cycle.

- i** Do not exceed recommended load: Overloading will cause poor wash results and encourage creasing.



- Close the loading door. Take care not to trap any items of clothing between the loading door and rubber seal.

Laundry Detergents and Additives

Dispensing the correct amount of detergent

⚠ Risk of poisoning!

Keep detergents and additives out of the reach of children.

Dispense the detergent according to:

- the water hardness. This information can be obtained from your local water authority.
- the amount of laundry.
- the amount of soil.
Information on soiling can be found on Page 14.
- the specifications of the detergent manufacturer.
Dispensing the correct amount of detergent relieves the strain on the environment and ensures optimum washing results.

Pour liquid detergent into the appropriate dispensing chamber.

Too little detergent:

The laundry is not cleaned properly and will, after a while, become grey and stiff.

Greyish brown spots (fat globules) may appear on the laundry.

The heaters may calcify.

Too much detergent:

Environmentally incompatible, excessive foam reduces wash agitation causing poor washing and rinsing results.

Filling laundry detergent and/or additive dispensers

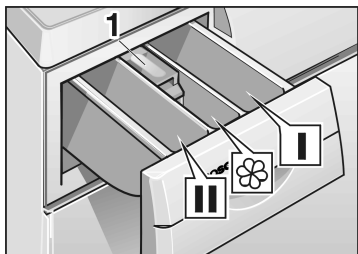

Dispenser I:
Detergent for prewash or starch.

Dispenser II
Detergent for main wash, water softener, pre-soaking agent, bleach and stain removal product.

Dispenser 
Additives, e.g. fabric softener or former (fill no higher than lower edge of insert **1**).

- i** Concentrated or thick fabric softener and conditioner must be diluted with a little water before being poured into the dispenser (prevents the overflow from becoming blocked).
- Pull out the detergent dispenser up to the end stop.
- Add the detergent and/or additive.
- Close the detergent dispenser.

Programmes and functions

Select the desired programme – see also the separate programme overview.

The maximum spin speeds of the programmes are dependent on the model. For adjusting the spin speed, see from Page 31.

Programme selector

30, 40, 60 °C Cottons+Linens

For hard-wearing textiles, e.g. cotton or linen. Maximum spin speeds.

60 °C Stains, Cottons+Linens

For stained, heavily soiled textiles, e.g. cotton or linen. Energy saving programme. The extended washing time achieves a cleaning result comparable to that of the 90 °C programme, but uses considerably less energy. Maximum spin speeds.

90 °C Cottons+Linens

An energy-intensive programme for heat-resistant textiles, e.g. cotton or linen. Maximum spin speeds.

To protect the waste-water pipes, the hot water is mixed with approx. 7 litres of cold water and cooled before being drained.

i “Cottons+Linens” programmes have optimised run times for lightly soiled textiles. For heavily soiled textiles reduce the load or press the “Wash Plus” button!

30 °C Mix

For hard-wearing cotton washing and easy-care textiles – different types of washing can be washed together.

Short wash time.

Reduced spin speed.

30, 40, 60 °C Easy-Care

For easy-care textiles, e.g. cotton, linen, synthetic materials or blended fabrics.

Reduced spin speed.

30 °C Delicates/Silk

For delicate, washable textiles, e.g. silk, satin, synthetic materials or blended fabrics (e.g. curtains).

Reduced spin speed.

Delicates cycle at 30 °C for hand and machine washable silk.

We do not recommend washing these textiles with other rougher textiles.

No spinning between rinse cycles.

cold, 30 °C Woollens

For hand and machine washable wool or wool-rich textiles, e.g. cashmere, mohair or angora.

Also suited for hand washable silk.

Reduced spin speed.

Extra cycle programme selector

Rinse/Freshen up

Rinse cycle with subsequent spin cycle for rinsing hand-washed laundry or for starching.

Also suited to “Freshen up” items, that have been tucked away or stored for a period of time, to remove creases caused by folding and storage and to eliminate odours.

Use fabric conditioner for “fresh” smell.

i Do not use detergent (this is not a wash programme).

Reduced spin speed.

Spin

Spin cycle for spinning hand-washed laundry.

Washing solution or rinsing water is drained prior to the spin cycle.

Reduced spin speed.

Drain

Water is drained after a programme with the “Without final spin” setting for gentle treatment of delicate laundry.

Maximum spin speeds of the programmes

Revolutions per minute	Type of laundry / Extra cycle
1400	Cottons+Linens
800	Mix
800	Easy-Care
600	Delicates/Silk
800	Woollens
1200	Rinse/Freshen up
1200	Spin

In the “Cottons+Linens” programme the fabrics will be spun at the maximum possible spin speed.

In the “Easy-Care”, “Delicates/Silk”, “Mix” and “Woollens” programmes the washing machine spins at a low speed – for gentle treatment of delicate laundry.

Display field

The first line displays operating and programme progress text left-justified and, if required, the current time right-justified (if text is long, the time is masked out).

The second line displays spin speeds and the expected end time of the programme as well as symbols for prewash, signal and childproof lock.

Spin speeds or without final spin

The maximum spin speed of the programme during the “Drain” programme “--- Ⓞ” (without final spin) is displayed.

The speeds can be deleted or “Without final spin” can be selected.

“Without final spin”:

The laundry remains lying in the water after the final rinse. Before the laundry can be unloaded, the “Drain” or “Spin” programme must be performed.

End time

The time is displayed when the programme will end.

Symbol for prewash

This symbol is on if prewash was selected. The selection of prewash applies only to the next programme.

Symbol for signal

This symbol is on if the signal volume was not set to “Off”.

Symbol for childproof lock

This symbol is on if “Child lock: ON” was selected in the menu.

Option buttons

Reduced Ironing

Gentler spin with subsequent fluffing. After the spin cycle the washing is arranged loosely in the drum – creasing is reduced.

Final spin speed for the “Cottons+Linens” programmes: 800 r.p.m.

Final spin speed for the “Easy-Care”, “Delicates/Silk” and “Mix” programmes: 600 r.p.m.

Observe maximum load for each type of textile; remove the washing as soon as the spin cycle is complete.

Rinse Plus

Extra rinse cycle.

The wash time is extended accordingly.

Recommended application:
in areas with very soft water.

Wash Plus

The washing time is extended so that highly soiled washing or 6 kg of cottons/linens are washed more intensively.

Press the button in addition to the programme for the following combinations of load and degree of soiling:

Laundry amount	Program and button "Wash Plus"	Degree of dirt
6 kg	30, 40, 60 °C Cottons+Linens	light to normal
	60 °C Stains Cottons+Linens	normal with stains
	90 °C Cottons+Linens	normal
up to 5 kg	30, 40, 60 °C Cottons+Linens	normal to heavy
	60 °C Stains Cottons+Linens	normal to heavy with stains
up to 3 kg	30 °C Mix	normal to heavy
	30, 40, 60 °C Easy-Care	
up to 2 kg	30 °C Delicates/Silk	normal to heavy
	cold, 30 °C Woollens	

See the separate programme table for further information.

- i** Effective combinations of programme and additional options are possible. Other combinations are rejected. A signal is emitted.

Indicator light in the “Start/Pause” button

The indicator light conveys the following information:

Indicator light **flashing red**

Programme can be started.

Top-up washing is possible.

Indicator light **glowing red**

Programme is running.

Top-up washing is possible.

Indicator light **flashing yellow**

Programme can be started.

Top-up with washing is not possible because the door is locked for reasons of safety.

Indicator light **glowing yellow**

Programme is running.

Top-up with washing is not possible because the door is locked for reasons of safety or because the childproof lock is active.

Indicator light **off**

Door is open and/or the programme has ended.

i Exception: If childproof lock was selected, the indicator light is on (yellow) at the end of the programme; the door is locked.

Load adjust

“Load adjust” matches the water and power consumption to each programme – according to the amount of washing and type of textiles. Water and energy consumption is therefore reduced when washing small amounts of laundry.

The flow sensor measures the water flow rate like an internal water gauge and meters the exact volume of water required by the amount of washing.

The stepless water level sensor ensures that the water level is correct in each programme for washing your laundry – from our economical coloureds programmes to the gentle “Delicates/Silk” and “Woolens” programmes.

Hyd. sensor

The hyd. sensor checks the degree of turbidity of the rinsing water. The duration and number of rinse cycles is dependent on the turbidity of the water.

You can therefore save water and time when washing lightly soiled washing with the appropriate amount of detergent.

Unbalanced load detection system

The automatic unbalanced load detection system spins the washing several times to ensure even distribution.

If the washing is very unevenly distributed, it is not spun for reasons of safety or the end speed is reduced.

In the woollens programme the washing is spun only twice to prevent matting.

Washing with standard settings

The specified standard settings are optimally adjusted to the selected programme.

These are:

- Spin speed: maximum, according to the type of washing.
- Prewash: no

If you do not want to change these standard settings:

- Turn on water tap.

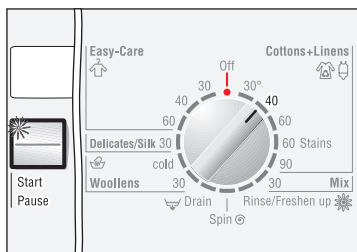

- Turn the programme selector to the desired programme.

- i** If the time has not been set, “Clock not set” is briefly indicated in the display field; “0:00” flashes. Set clock; see from Page 39.

- Load the laundry and close the loading door. The “Start/Pause” indicator light flashes (red).

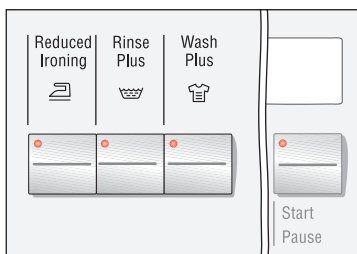

- If required, press the button(s) for additional option(s). The indicator light of the selected button is on (red).

- i** If an illogical combination was inadvertently selected – e.g. “Reduced Ironing” “ and “Drain” – the indicator light of the selected button goes out and a signal is emitted.

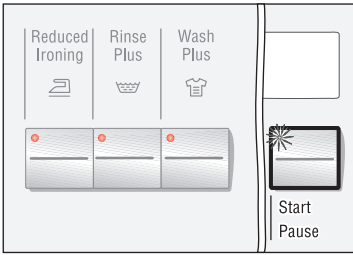

- ❑ Press the “Start/Pause” button.
The indicator light is on (red). The programme starts.
- ❑ **i** The individual programme steps are indicated in the display field.

Washing with individual settings is described subsequently.

Washing with individual settings

You can adjust the settings to your requirements. First find a quick overview of the adjustable settings. The steps for changing the settings are described in detail overleaf.

Quick overview

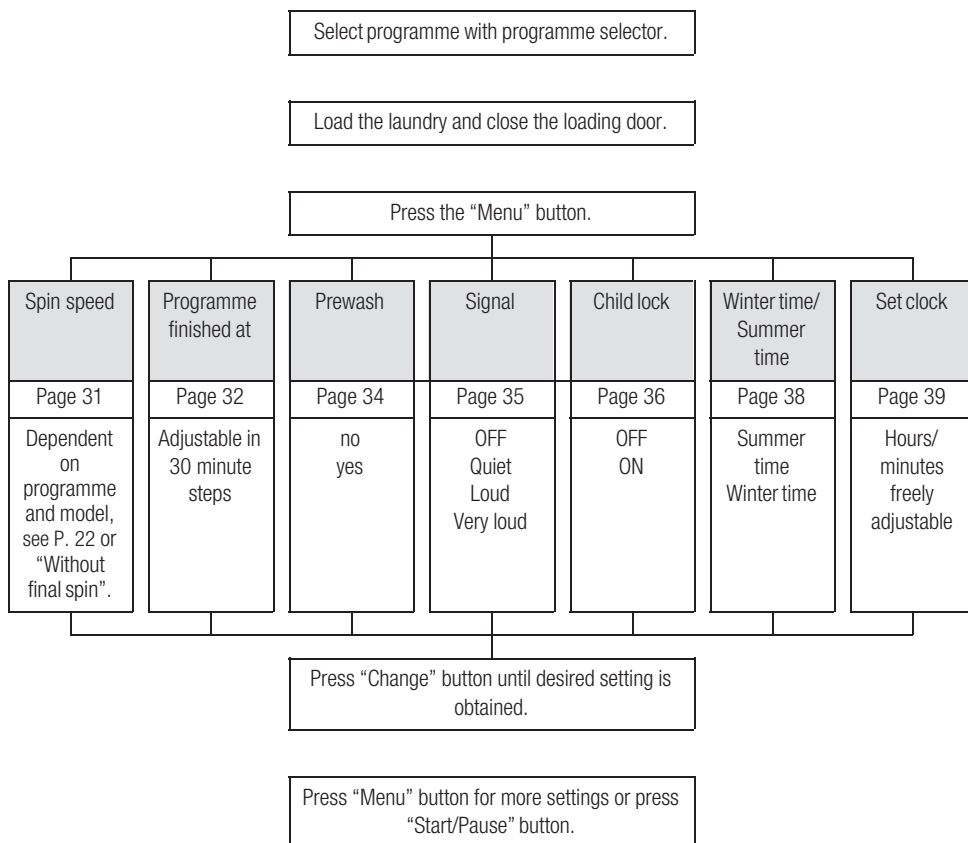

Spin speed

You can reduce the displayed spin speed.

The maximum displayed spin speed depends on the selected programme.

See also information on Page 22.

- Turn the programme selector to the desired programme.
- Load the laundry and close the loading door.
The “Start/Pause” indicator light flashes (red).

Example:

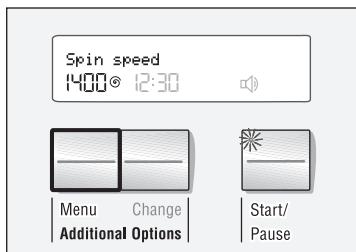

- Press the “Menu” button until, “Spin speed” is displayed.
Current spin speed flashes.
The “Start/Pause” indicator light flashes (red).

i The menu is left if a button is not pressed within 10 seconds.

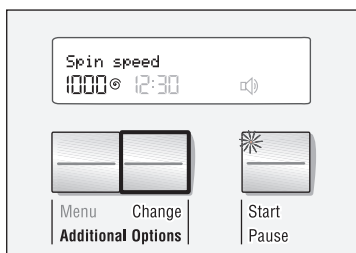

- Press the “Change” button until the desired spin speed or “Without final spin ---- G” is displayed.

You can change other settings
or

- Press the “Start/Pause” button.
The programme starts.
The indicator light is on.

i The individual programme steps are indicated in the display field.

Programme finished at

Make sure that the time has been set – see “Set clock”, Page 39.

Before starting a programme, you can specify the time at which the programme ends.

- Turn the programme selector to the desired programme.
- Load the laundry and close the loading door. The “Start/Pause” indicator light flashes (red).
- Select an additional option.

Example:

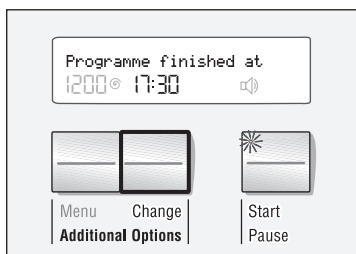
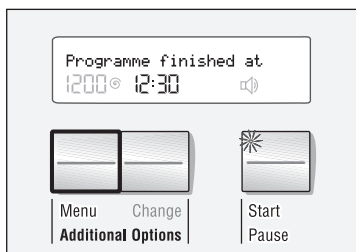

- Press the “Menu” button until, “Programme finished at” is displayed. Current end time flashes. The “Start/Pause” indicator light flashes (red).
- i** The menu is left if a button is not pressed within 10 seconds.
- Press the “Change” button until the programme end time is displayed. The programme end can be set in 30 minute steps. The time can be programmed up to a maximum 24 hours in advance.
- i** The end time must be reset if the programme, additional options or the current time is changed.
- i** If there is a small load of lightly soiled washing, the programme may end well before the selected end time. If there is a large load of heavily soiled washing, the programme may end several minutes after the selected end time.

You can change other settings
or

- Press the “Start/Pause” button. The delayed Start is activated. The indicator light is on.

“Time delay” is indicated in the display field.

- i To save energy, all displays are switched off 30 seconds after the buttons were last pressed. If the “Change” button is pressed, the displays are switched on again.

Prewash

For heavily soiled washing you can actuate "Prewash".

- i** "Prewash" is not possible in the "Mix 30", "Woollens", "Rinse/Freshen up", "Spin" and "Drain" programmes.
- Turn the programme selector to the desired programme.
- Load the laundry and close the loading door. The "Start/Pause" indicator light flashes (red).

Example:

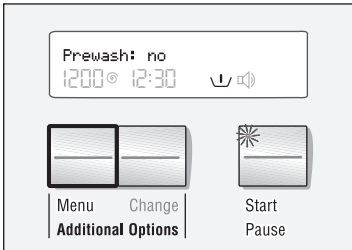

- Press the "Menu" button until "Prewash:" is displayed. The "⌵" symbol flashes. The "Start/Pause" indicator light flashes (red).
- i** The menu is left if a button is not pressed within 10 seconds.

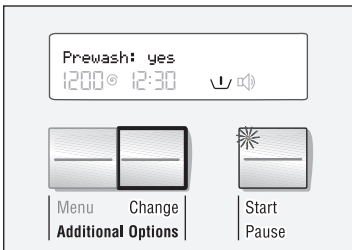

- Press the "Change" button until "Prewash: yes" or "Prewash: no" is displayed.
- i** When the menu is left, the "⌵" symbol is permanently displayed.

You can change other settings
or

- Press the "Start/Pause" button. The programme starts. The indicator light is on.
- i** The individual programme steps are indicated in the display field.

Signal

The acoustic signal indicates the start or end of the programme, operating errors or malfunctions.

You can specify the volume of the acoustic signal.

- Turn the programme selector to the desired programme.
- Load the laundry and close the loading door. The “Start/Pause” indicator light flashes (red).

Example:

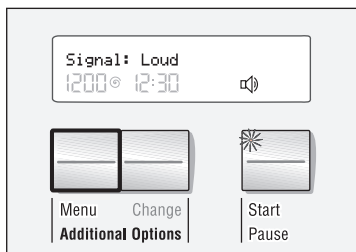

- Press the “Menu” button until “Signal:” is displayed. The “” symbol flashes. The “Start/Pause” indicator light flashes (red).

i The menu is left if a button is not pressed within 10 seconds.

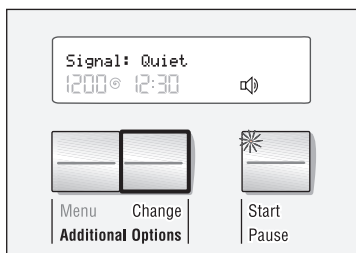

- Press the “Change” button until the desired signal volume is displayed.

i The selected setting is retained after the wash cycle.

You can change other settings
or

- Press the “Start/Pause” button. The programme starts. The indicator light is on.

i The individual programme steps are indicated in the display field.

Child lock

You can secure your washing machine to prevent selected functions from being inadvertently changed.

If the childproof lock has been selected:

- No changes can be made while the programme is running,
- Should the appliance be switched off and on while a programme is running the programme will continue at the point at which it was interrupted,
- The door remains locked at the end of the programme,
- Directly after the appliance is switched on – provided no programme was active the last time the appliance was switched off – all control elements are disabled and the door is locked.

i If the childproof lock is active and the programme selector is rotated while a programme is running, the indicator light of the programme selector goes out. The indicator light illuminates again when the programme selector is returned to its original position.

i When a programme has started, you can activate the childproof lock in “Pause” mode only.

- Turn the programme selector to the desired programme.
- Load the laundry and close the loading door. The “Start/Pause” indicator light flashes (red).

Activating the childproof lock

Example:

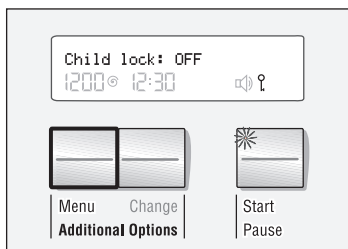

Press the “Menu” button until “Child lock: OFF” is displayed. The “” symbol flashes.

i The menu is left if a button is not pressed within 10 seconds.

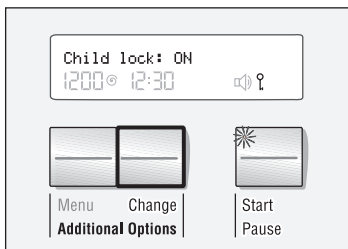

- Press the “Change” button until “Child lock: ON” is displayed.
- When the menu is left, the “?” symbol is permanently displayed.
- The childproof lock is not activated until the “Start/Pause” button is pressed. The “Start/Pause” indicator light is permanently illuminated (yellow).

You can change other settings
or

- Press the “Start/Pause” button. The programme starts. The indicator light is on (yellow). Childproof lock activated.
- The individual programme steps are indicated in the display field.
- Press the “Start/Pause” button and hold down (5 seconds) until the “Start/Pause” indicator light flashes.

Deactivating temporarily the childproof lock

- When “Pause” is displayed, the childproof lock is temporarily deactivated.
- When the “Start/Pause” button is pressed again, the childproof lock is re-activated.

Deactivating permanently the childproof lock

- If required, press the “Start/Pause” button and hold down (5 seconds) until the “Start/Pause” indicator light flashes.
- Press the “Menu” button until “Child lock: ON” is displayed. The “?” symbol flashes.
- Press the “Change” button until “Child lock: OFF” is displayed.

Winter time/ Summer time

Example:

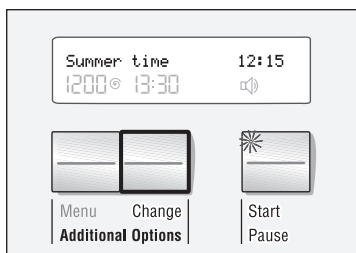
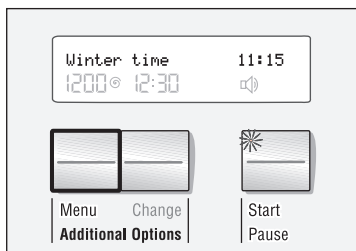

- You can switch from winter to summer time.
- Turn the programme selector to the desired programme.
 - Load the laundry and close the loading door. The “Start/Pause” indicator light flashes (red).

- Press the “Menu” button until “Winter time” or “Summer time” is displayed. The “Start/Pause” indicator light flashes (red).
- i** The menu is left if a button is not pressed within 10 seconds.

- Press the “Change” button and select summer or winter time.

- i** The selected setting is retained after the wash cycle.

You can change other settings
or

- Press the “Start/Pause” button. The programme starts. The indicator light is on.
- i** The individual programme steps are indicated in the display field.

Set clock

You can set the current time. The settings are retained even if your washing machine is not used for up to 6 weeks.

- ❑ Turn the programme selector to the desired programme.
- ❑ Load the laundry and close the loading door. The “Start/Pause” indicator light flashes (red).

Example:

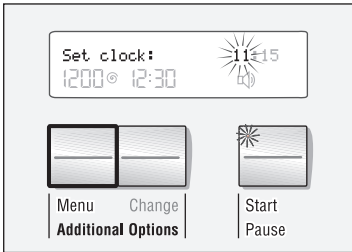

- ❑ Press the “Menu” button until “Set clock:” is displayed. The hour display flashes. The “Start/Pause” indicator light flashes (red).
- i** The menu is left if a button is not pressed within 10 seconds.

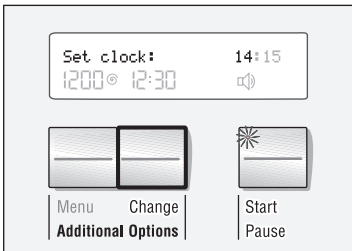

- ❑ Press the “Change” button until the hour display is correct.

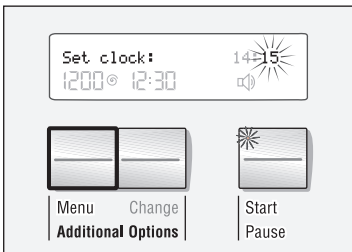

- ❑ Press the “Menu” button until the minute display flashes. The “Start/Pause” indicator light flashes (red).

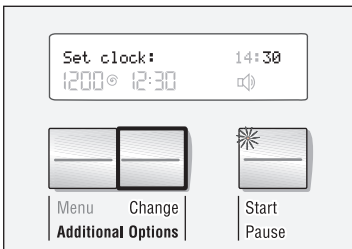

- ❑ Press the “Change” button until the minute display is correct. The time is now set.
- i** Press the “Menu” button, the menu function ends.

You can change other settings
or

- Press the “Start/Pause” button.
The programme starts.
The indicator light is on (red).
- i** The individual programme steps are indicated in the display field.

Resetting the settings

You can reset all changed settings to the standard settings except the time and language.

- ❑ Turn the programme selector to the desired programme.
- ❑ Press the “Change” button and hold down (3 seconds) until the second acoustic signal is emitted.
- ❑ **i** The standard settings have now been selected. These are:
 - Spin speed: maximum
 - Prewash: no
 - Signal: Loud
 - Child lock: OFF
- ❑ **i** The “Resetting the settings” function is not available if the washing programme is running, if the childproof lock has been activated or if the “Menu” button has been pressed.

During washing

Reselecting a programme

If you have accidentally selected the wrong programme:

- If the childproof lock is active, temporarily deactivate; see Page 37.
- Turn the programme selector to “Off”.
- Turn the programme selector to a newly selected programme.
The “Start/Pause” indicator light flashes.
- If the childproof lock is active, deactivate again temporarily.
- If required, change the settings; see from Page 30.
- Press the “Start/Pause” button.
The programme starts.
The indicator light is on.

Topping up the washing/ Interrupting the programme

You can put washing in the drum later, take washing out of the drum early or interrupt the programme at any time.

Without childproof lock

- i** You can top up or reduce washing as long as the “Start/Pause” indicator light is on (red).
- Press the “Start/Pause” button.
In the display field are indicated in succession: “Pause”, “Door can be opened”.
- Open the loading door.
- Load/remove the washing.
- Close the loading door.
- Press the “Start/Pause” button.
Programme continues.
The indicator light is on (red).

Childproof lock activated

- i** If the “Start/Pause” indicator light is on (yellow), the programme can be interrupted, however the door cannot be opened for reasons of safety (water level, temperature or speed too high).
In the display field are indicated in succession:
“Pause”,
“Door cannot be opened”.
- i** If the “Start/Pause” indicator light is on (yellow) because the speed is too high, top-up is possible in “Pause” mode when the drum is at a standstill.
- Temporarily deactivate the childproof lock.
See Page 37.
- i** If the “Start/Pause” indicator light flashes (yellow), the door cannot be opened for reasons of safety (water level, temperature or speed too high).
In the display field are indicated in succession:
“Pause”,
“Door cannot be opened”.
- i** If the “Start/Pause” indicator light flashes (red), the washing can be topped up or removed prematurely.
In the display field are indicated in succession:
“Pause”,
“Door can be opened”.
- Open the loading door.
- Load/remove the washing.
- Close the loading door.
- Press the “Start/Pause” button.
Programme continues.
Childproof lock is re-activated.
The indicator light is on (yellow).

Cancelling active programme

If you would like to terminate a programme and remove the washing:

- If the childproof lock is active, temporarily deactivate; see Page 37.
- Turn the programme selector to “Drain”, “Spin” or “Rinse/Freshen up”.
- i** If a programme is interrupted at a high temperature, “Rinse/Freshen up” should be selected to cool down the washing.
- Press the “Start/Pause” button.
- Wait until programme ends.
- If the childproof lock is active, deactivate again temporarily; see Page 37.
- Open the loading door.
- Unloading the laundry.
- i** If a programme is interrupted at a high temperature and “Rinse/Freshen up” has not been selected, the door may remain locked until the appliance has cooled down.
- i** If the programme is terminated by switching off the appliance, the door may remain locked.

After washing



The “Start/Pause” indicator light goes out.
Display field: “Remove washing”.

- Open the loading door.
- Turn the programme selector to “Off”.

or

“Without final spin” preselected

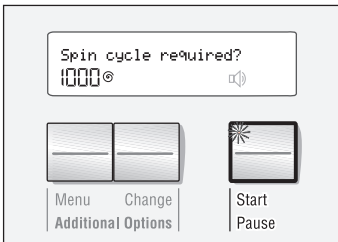

The “Start/Pause” indicator light flashes.

- If required, change the spin speed; see from Page 31.
- Press the “Start/Pause” button.
The programme starts. The programme progress is indicated in the display field.
The indicator light is on.

or

- Turn the programme selector to “Drain”.
The “Start/Pause” indicator light flashes.
- Press the “Start/Pause” button.
The indicator light is on.
Display field: “Draining water”.
- When the additional programme has ended, open the door.
- Turn the programme selector to “Off”.

“Child lock: ON” preselected



The “Start/Pause” indicator light is on (yellow).
Display field: “Remove washing”.

- Press and hold down the “Start/Pause” button (5 seconds) until “Remove washing” is displayed. The “Start/Pause” indicator light does not illuminate.
- Open the loading door.
- Turn the programme selector to “Off”.
- Turn off the water tap.

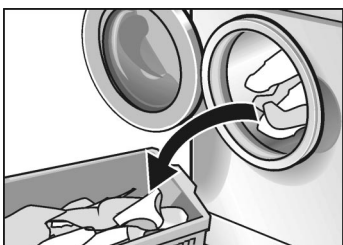

- Unload the laundry.
- i** The childproof lock is reactivated the next time the appliance is switched on.

Caution

Remove any foreign objects (e.g. coins, paper clips) from the drum and rubber seal – **risk of rust!**

- i** Leave the loading door open to allow the inside of the washing machine to dry out.

Emergency lock release

When the emergency lock release has been actuated, the loading door can be opened and the washing taken out of the drum.

⚠ Danger!

Allow the hot washing solution to cool.
Wait until the drum has come to a standstill.

Caution

The door can be unlocked at any time, even if the washing machine is full of water; never open the door if you can see water through the window.

⚠ Risk of scalding!

- Turn the programme selector to “Off”.
Any programme which was running is interrupted.
- Drain the water; see Page 52.
- Pull the emergency lock release,
The loading door can be opened.

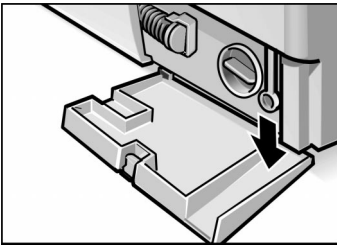

Special Applications

Pre-soak

- Load laundry of the same colour.
- Add the presoak agent to chamber **II** according to the manufacturer's specifications.
- Turn the programme selector to "30 °C Cottons+Linens".
The "Start/Pause" indicator light flashes (red).
- Press the "Start/Pause" button.
The programme starts.
The indicator light is on (red).
- After approx. 10 minutes, turn the programme selector to "Off". The laundry is left to lie in the water.
- Select a programme after the desired soaking period.
- i** No additional detergent required, the soaking solution is used for washing.

Starching

The laundry must not be treated with fabric softener.

- Load the laundry.
- Dispense the correct amount of starch for approx. 15 litres / 3.3 gal. of water. Powdered starch must first be dissolved in water according to the manufacturer's specifications.
- Turn the programme selector to "Rinse/Freshen up".

- Set the spin speed (“Without final spin” is also possible).
- Press the “Start/Pause” button.

As soon as water starts to enter the machine:

- Pull out the detergent dispenser slightly.
- Add the starching solution to chamber **I**.
- Close the detergent dispenser.

If the “Without final spin” option is selected, the “Drain” programme must subsequently be selected.

Only use dyes that are environmentally compatible and suitable for use in washing machines.

Caution

Discoloration of the laundry in subsequent wash cycles cannot be completely ruled out.

- Always use dyes in accordance with the manufacturer’s instructions.

After dyeing:

- Pour ½ measuring beaker of detergent into dispenser **II**.
- Without any laundry in the drum, allow the “90 °C Cottons+Linens” programme to run through.
- Wipe out the rubber seal.

Caution

Decolorants may contain sulphur or chlorine. These substances can cause parts of the washing machine to corrode. Do not decolorize items of laundry in the washing machine.

Dyeing

Decolorizing

Cleaning and Care

⚠ Risk of electric shock!

Always disconnect the appliance from the mains before cleaning.

Never clean the washing machine with a jet of water.

⚠ Risk of explosion!

Never use solvents to clean the appliance.

As required:

- Use hot soapy water or a mild, non-abrasive cleaning agent.
- Rub dry with a soft towel.

In the event that rust spots have formed due to left-over debris (e.g. coins, paper clips, needles, nails):

- Use a chlorine-free cleaning agent. Follow the manufacturer's instructions. Never use steel wool.

Cleaning the appliance housing and control panel

Cleaning the drum

Cleaning the detergent dispenser



- Pull out the detergent dispenser up to the end stop,
- Press down the insert and
- Remove the detergent dispenser.

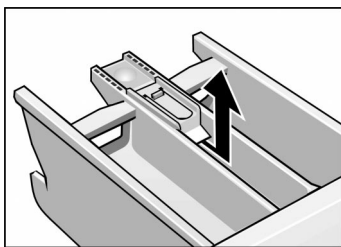

- Pull out the insert.
- Clean the detergent dispenser and insert under running water and dry.

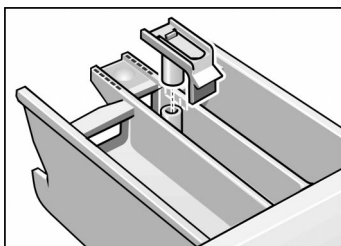

- Attach the insert and lock into position.
- Insert the detergent dispenser.

Cleaning the drain pump

Draining the washing solution

This is necessary if the washing solution has not been completely drained. The pump is blocked by either loose debris or fluff which accumulates if fluff-giving fabrics are washed.

(Up to 20 litres / 4.4 gal. Have a suitable container ready.)

⚠ Risk of scalding!

Allow the hot washing solution to cool.
Keep children and pets away.

- Turn the programme selector to “Off”.
- Open service flap.

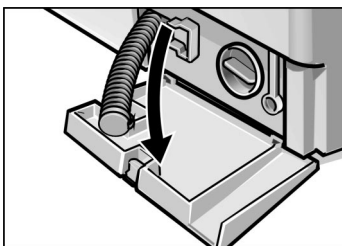
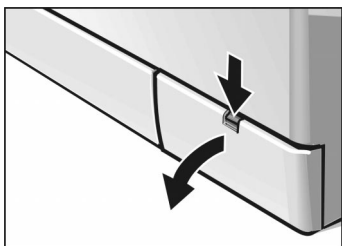

- Remove the drain hose from its holder and pull the hose out of the housing.
- Remove service flap.

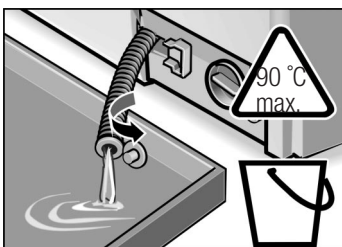

- Pull down the closing cap and allow the washing lye to flow into a suitable container.

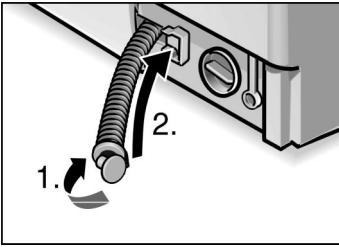

- ❑ Push up the closing cap (**1st**) and place the drain hose back in its holder (**2nd**).

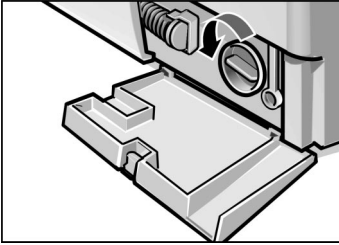

- ❑ Carefully remove the pump cap.
A little residual water will flow out.
- ❑ Remove any loose debris / fluff from inside the pump and clean the pump. The pump impeller must be able to rotate.
Clean any residual lye or fluff from the thread of the pump cap and pump housing.

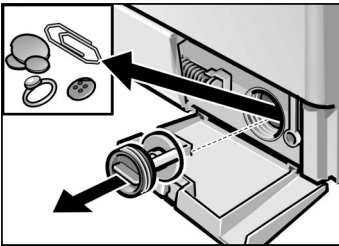

- ❑ Attach and tighten the pump cap.
- ❑ Insert and close service flap.

To avoid unused detergent from flowing into the drain during the next wash cycle:

- ❑ Pour 1 litre / 1 ¾ pt of water into chamber II.
- ❑ Select the “Drain” programme.

Cleaning water inlet strainers

This is necessary if very little or no water flows into the washing machine.

First release the water pressure in the supply hose:

- ❑ Turn off the water tap.
- ❑ Turn the programme selector to any programme (except “Spin G” and “Drain”).
- ❑ Press “Start/Pause” button and wait for “Water tap closed?” message.
- ❑ Turn the programme selector to “Off”.

Cleaning the strainer at the water tap

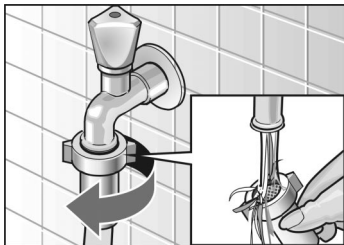

- Disconnect the hose from the water tap.
- Rinse the strainer under flowing water.
- Connect the hose.

Cleaning the strainer on the washing machine

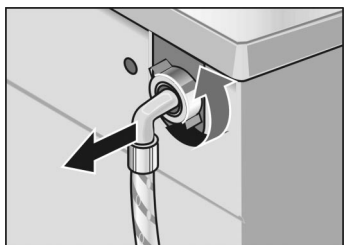

- Disconnect the hose from the back of the washing machine.

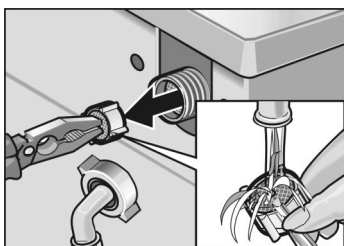

- Pull out the strainer and rinse under running water.
- Insert the strainer and reconnect the hose.
- Turn on the water tap and check whether water is still discharged. If water is still discharged, check that the strainer is attached properly.
- Turn off the water tap.

Descaling the washing machine

Caution

Descaling agents contain acids which can attack parts of the washing machine and discolour the laundry.

Provided that you use the correct amount of detergent, it is not necessary to descale the washing machine.

If, however, descaling the appliance becomes necessary, please follow the instructions provided by the descaling agent manufacturer.

Troubleshooting Minor Faults

⚠ Risk of electric shock!

Repairs must only be carried out by our Customer Service or an authorized technician.

If repairs are needed, and assuming that you cannot eliminate the fault yourself with the aid the following table:

- Turn the programme selector to “Off”.
- Disconnect the washing machine from the mains.
- Turn off the water tap.
- Call Customer Service (refer to Page 62).

Fault	Possible cause	Action
The loading door cannot be opened.	“Without final spin” selected.	Select “Drain” or “Spin”.
	Childproof lock activated.	Deactivate childproof lock, see Page 37.
	Power failure.	An interrupted programme will be resumed when power returns. If the washing is to be removed during a power failure, proceed as described under “Emergency lock release”; see Page 47.
	Programme is running and/or the door is locked for reasons of safety.	Wait until the programme ends; see Page 42.
	Plug is loose or not inserted.	Eliminate the cause.
	Programme selector turned to “Off” before end of programme.	Select a programme.

Fault	Possible cause	Action
Door cannot be opened, even though the appliance has been switched off and on again.	Childproof lock activated. For reasons of safety the door has been locked because the water level, temperature or speed is too high.	Deactivate childproof lock, see Page 37. See "Topping up the washing/Interrupting the programme", Page 42.
Programme continues running, even though the appliance has been switched off and on again.	Childproof lock activated.	Deactivate childproof lock, see Page 37.
Appliance cannot be operated. "Child lock activated" is indicated in the display field.	Childproof lock activated.	Deactivate childproof lock, see Page 37.
Control lights do not come on.	A fuse has triggered. Power failure.	Switch on / replace the fuse. Call Customer Service if this fault is repeated. An interrupted programme will be resumed when power returns. If the washing is to be removed during a power failure, proceed as described under "Emergency lock release"; see Page 47.
	Appliance is in energy-saving mode. This is not a fault.	Press the "Change" button; energy-saving mode is terminated.
Programme does not start. "Start/Pause" indicator light flashes.	"Start/Pause" button not pressed.	Press the "Start/Pause" button.
Programme does not start. "Door open?" indicated in the display field.	Loading door not closed properly.	Check whether laundry is trapped in door. Close the loading door (a click should be heard). Programme continues.
"Press start" is indicated in the display field.	End time selected but still not activated by pressing the "Start/Pause" button.	Press the "Start/Pause" button.

Fault	Possible cause	Action
Programme does not start. "Time delay" is indicated in the display field.	End time selected and activated.	None. Appliance starts automatically.
Clock cannot be set.	Programme has already started; when a programme has started, the clock cannot be set.	Wait until programme ends.
"Set clock:" text remains in the display field even though the "Menu" button has been pressed.	The setting has switched from hours to minutes; both selection points have the same text.	None.
"--:--" is displayed instead of the end time in the display field.	Clock not set.	Set clock; see Page 39.
End time cannot be selected.	Clock not set.	Set clock; see Page 39.
	Programme has already started; when a programme has started, the end time can no longer be selected.	Reselect programme; see Page 42. Before starting the programme, select and start the desired end time; see Page 32.
Prewash cannot be selected.	Programme has already started; when a programme has started, prewash can no longer be selected.	Reselect programme; see Page 42. Before starting the programme, select and start "Prewash: yes"; see Page 34.
	A programme was selected which does not allow prewash.	Select a programme which allows prewash; see Page 34.
Spin speed cannot be selected.	Spinning is already in progress; during spinning the speed cannot be changed.	Select speed before spinning.
	Programme selector is set to "Drain"; spinning is not possible with this programme.	If required, select another programme.
Maximum spin speed cannot be adjusted.	"Reduced Ironing" additional option selected. This is not a fault.	If required, delete "Reduced Ironing" additional option.
Childproof lock cannot be selected.	The programme has already started.	Childproof lock can be selected in pause mode.

Fault	Possible cause	Action
Detergent residue in the detergent dispenser.	Detergent was damp or lumpy.	Clean and dry the detergent dispenser; see Page 51. Use the dispensing aid for liquid detergents.
Water does enter the machine or detergent is not washed away. "Water tap closed?" indicated in the display field.	Water tap not turned on.	Turn on water tap. Programme continues.
	Supply hose kinked or trapped.	Eliminate the cause.
	Strainers in supply hose clogged.	Clean the filter; see Page 53.
"Water tap closed?" is displayed even though a lot of water has run in.	Water pressure too low.	Eliminate the cause.
	Safety function has detected an appliance fault.	Do not open the door, as water may run out! Repeatedly select the "Drain" programme. When the appliance has been completely drained, the washing can be removed. Call customer service.
Water cannot be seen in drum.	This is not a fault. The water lies below the visible part of the drum.	
Washing solution is not completely drained. "Pump blocked?" indicated in the display field.	Loose debris is blocking the pump.	Clean the pump (refer to Page 52).
	The water drainage pipe and/or drain hose is blocked.	Clean the water drainage pipe and/or drain hose.
Water is flowing out from underneath the machine.	The thread of the supply hose is not tight.	Tighten the thread.
	Leak in the drain hose.	Replace the drain hose.
Foam coming out of the detergent dispenser.	Too much detergent.	Mix 1 tablespoon of fabric softener with ½ litre / 1 pt of water and pour into chamber II of the detergent dispenser.
		Reduce the amount of detergent next time.
Repeated spinning.	This is not a fault. The imbalance compensation system is attempting to balance the load through repeated spins.	Always load large and small items together into the drum.

Fault	Possible cause	Action
The laundry was not spun.	Large items of clothing became entangled and could not be distributed evenly in the drum. For reasons of safety the high-speed spin cycle was automatically suppressed.	Always load large and small items together into the drum.
Programme duration extended.	This is not a fault. Hyd. Sensor has extended the rinse sequence.	
	This is not a fault. The foam detection feature has activated an additional rinsing cycle to reduce the amount of foam.	Add a more appropriate amount of detergent next time.
	This is not a fault. The imbalance compensation system is attempting to balance the load through repeated spins.	Always load large and small items together into the drum.
Unsatisfactory washing result.	The degree of dirt was higher than supposed or recommended load has been exceeded.	Select suitable programme and press the "Wash Plus" button or reduce load.
	Not enough detergent.	Add detergent according to the manufacturer's specifications.
Detergent residue on the laundry.	Some phosphate-free detergents contain water-insoluble residues that may appear as light spots on the laundry.	Select "Rinse/Freshen up" immediately or brush out the washing after drying.
Grey residues on the laundry.	Dirt accumulation from ointments, fats or oils.	Add the maximum amount of detergent and select the highest permissible temperature next time.

Fault displays

Text in display field	Possible cause	Action
"Water tap closed?"	Water tap not turned on.	Turn on water tap. Programme continues.
	Supply hose kinked or trapped.	Eliminate the cause.
	Strainer in supply hose clogged.	Clean the filter; see Page 53.
	Water pressure too low.	Eliminate the cause.
"Pump blocked?"	Loose debris is blocking the pump.	Clean the pump (refer to Page 52).
	The water drainage pipe and/or drain hose is blocked.	Clean the water drainage pipe and/or drain hose.
"Door open?"	Loading door not closed properly.	Check whether laundry is trapped in door. Close the loading door.

If the fault cannot be rectified with the aid of the above table: switch off the appliance, wait 5 seconds, then switch on the appliance, select and start the programme.

If the fault recurs, call customer service; see Page 62.

Consumption Rates

Normal programme	Option buttons	Load	Consumption rates **		
			Electricity	Water	Duration
40 °C Cottons + Linens *	Wash Plus	6 kg / 13.2 lb	0.65 kWh	58 l	130 min.
60 °C Cottons + Linens	–	5 kg / 11 lb	0.95 kWh	58 l	77 min.
60 °C Stains, Cottons + Linens *	Wash Plus	6 kg / 13.2 lb	1.02 kWh	43 l	120 min.
90 °C Cottons + Linens (the hot washing solution is mixed with approx. 7 litres of cold water before being drained)	Wash Plus	6 kg / 13.2 lb	2.1 kWh	65 l	130 min.
40 °C Easy-Care *	Wash Plus	3 kg / 6.6 lb	0.5 kWh	50 l	78 min.
30 °C Mix	–	3 kg / 6.6 lb	0.3 kWh	35 l	35 min.
30 °C Delicates / Silk	–	2 kg / 4.4 lb	0.3 kWh	42 l	35 min.
30 °C Woollens *	Wash Plus	2 kg / 4.4 lb	0.2 kWh	35 l	50 min.

* Programme setting with “Wash Plus” option for test in accordance or in conformity with EN 60 456 and IEC 60 456

** The consumption rates may deviate from the stated values depending on water pressure and hardness, water inlet temperature, room temperature, type and amount of laundry, detergents used, fluctuations in the mains voltage and selected additional functions.

The Hydro sensor affects the volume of water and rinsing times; as a result different consumption values are possible depending on the load.

Customer service

Before calling the Customer Service, please make sure that you cannot eliminate the fault yourself (refer to Page 55).

This is because consultation provided by our technicians, even within the warranty period, will lead to costs being incurred by yourself.

Your nearest Customer Service centre can be found in the index supplied. When calling the Customer Service, please specify the product number (E-Nr.) and production number (FD-Nr.) of your appliance.

These numbers are shown on the rating plate which can be found on the frame of the open door and also on the identification plate, enclosed by a thick line, on the front of the machine behind the nameplate.

Rating plate

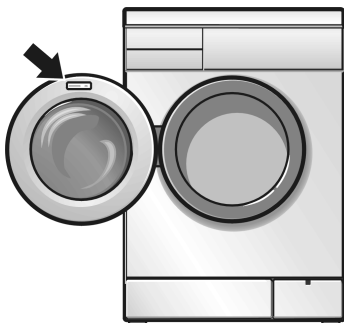

E-Nr. _____	FD _____
-------------	----------

Product number

Production number

Please note the two numbers in the space provided above.

In specifying the product number and production number of your appliance, you help us in our attempt to prevent unnecessary travelling and the associated extra costs.

Installation, Connection and Transport

Safety instructions

⚠ Risk of injury!

The washing machine is very heavy. Take care when lifting it.

Caution

Frozen hoses can tear / burst. Do not install the washing machine outdoors or in an area prone to frost.

Take care not to damage the washing machine. Do not hold onto protruding parts (e.g. loading door) when lifting.

In addition to the safety information listed here, the local water and electricity supplier may have special requirements.

If in any doubt, have the water connection carried out by an authorized technician.

Supplied accessories

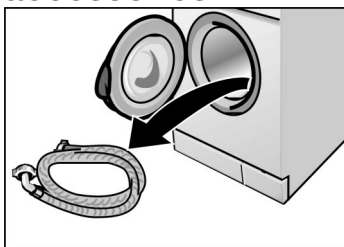

Inside the drum:

- Water-inlet hose.

Any dampness inside the drum is left over from final testing which every washing machine is subjected to before leaving the factory.

On the rear of the appliance:

- Water drainage hose.
- Elbow for attaching the drain hose, e.g. into a wash basin.
- Power cord with mains plug.

Depending on the connection situation:

- 1 hose clip \varnothing 24–40 mm (DIY store) is also required for connection to a siphon.

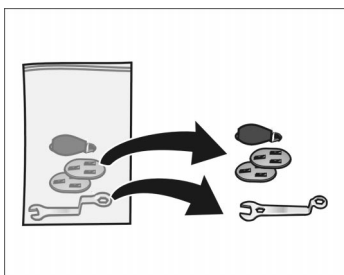
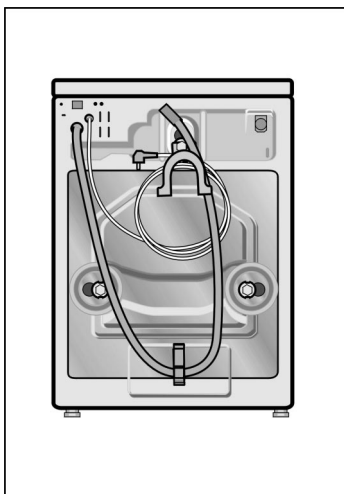

Useful tools

In the bag:

- Spanner,
- Covers for holes left by removing the transport bolts.

The following tools are helpful:

- Ring wrench (SW 13) for removing the transport bolts.
- Spirit level for aligning the appliance.

Dimensions

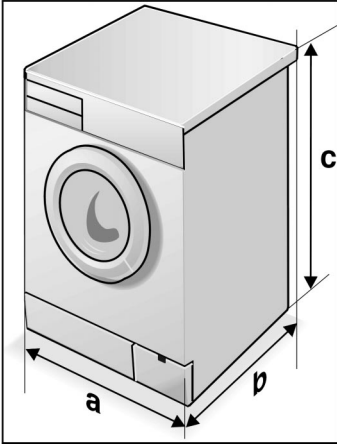

a = 600 mm

b = 590 mm

c = 852 mm

Weight approx. 69 kg

Installation area

Appliance stability is important so that the washing machine does not “wander” during the spin cycles.

The installation area must be solid and even. Soft floor surfaces, such as carpets or surfaces with foam backing, are not suitable.

If the washing machine is to be installed on a wood joist ceiling:

- If possible, place the washing machine in a corner of the room.
- Screw a water-resistant wooden board (at least 30 mm thick) to the floor.
- Affix the feet of the washing machine using holding brackets*.

If the washing machine is to be placed on a pedestal:

- Affix the feet of the washing machine using holding brackets*.

* Holding brackets (set) can be obtained from a specialist store or the Customer Service (order no. WMZ 2200).

Built-under or built-in appliance installation

The appliance must be built under or built in prior to connecting the power supply.

The appliance can be built into or under a kitchen work surface. For this purpose, a recess width of 60 cm is required.

- The washing machine must only be installed under a one-piece worktop that is permanently attached to the surrounding cabinets.

Caution

For safety reasons in built-under installation, a metal cover* must be assembled by a specialist in place of the appliance cover plate.

- * The metal cover (set) can be obtained from a specialist store or the Customer Service (order no. WMZ 2340).

Removing the transport bolts

Before removing the transport bolts

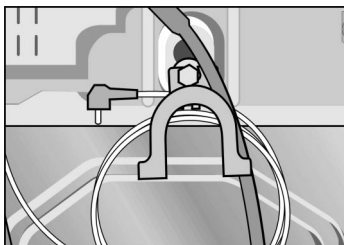

Removing the transport bolts

⚠ Caution

The transport bolts must always be removed before using the appliance for the first time.

- Take the hose out of the holders.
- Detach the elbow.

- Release screws **1**, **2** and **3** using the SW 13 wrench until they can be moved freely.

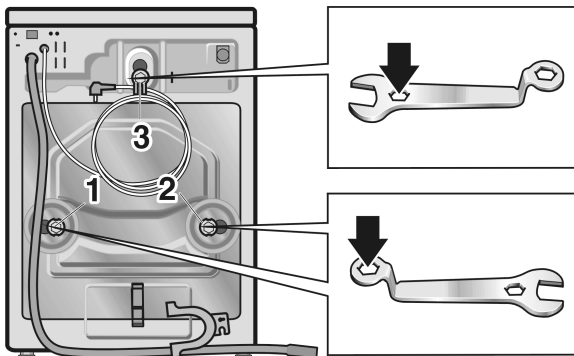

- Completely remove transport bolts **1** and **2** (bolt, washer and bushing).
- Completely remove transport bolt **3** (bolt, spring, washer and bushing), gripping the drum with one hand through the open door and pulling forwards slightly.

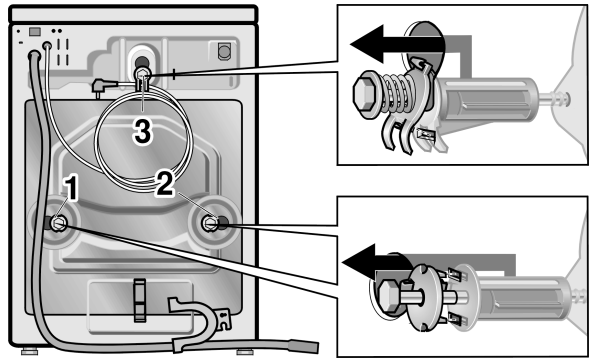

- Insert the covers.

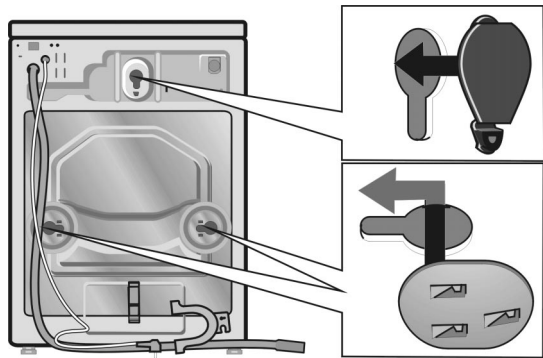

Storing the transport bolts

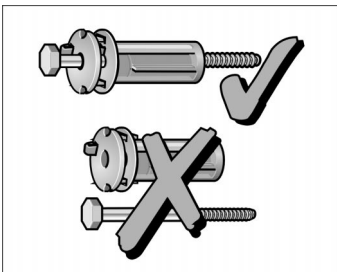

Always keep the transport bolts for subsequent transportation of the appliance (e.g. when moving house).

- Store transport bolts **1** and **2** (screw washer and bushing onto bolt).

Hose and cable lengths

Left-hand connection

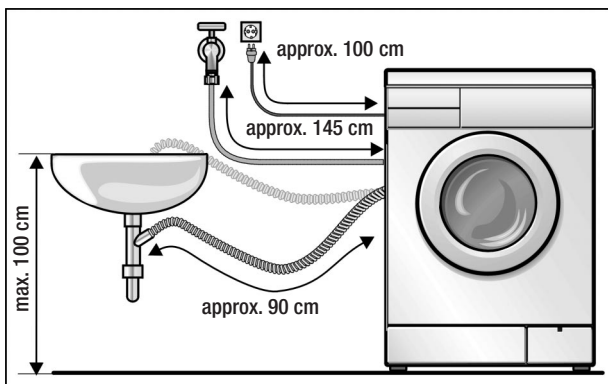

Right-hand connection

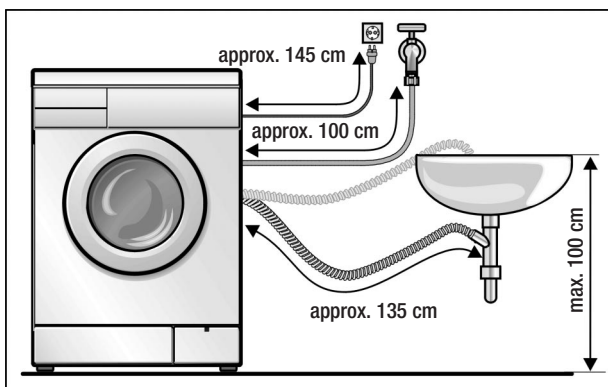

Other hoses

Available from specialist dealers:

- Connecting kit with plastic hose (approx. 2.50 m), order no. WMZ 2380.
- Extended supply hose (approx. 2.20 m).

Water connection

Water supply

To prevent leaks or water damage, it is essential to follow the instructions in this chapter!

Caution

Operate the washing machine with cold drinking water only. Do not connect the appliance to the mixer tap of an unpressurized hot-water boiler.

If in any doubt, have the water connection carried out by an authorized technician.

The water supply hose must not be:

- Bent or squashed.
- Modified or cut through (stability can no longer be guaranteed).

Plastic threads must only be tightened by hand. Do not remove the strainers from the water supply hose.

Observe the water pressure in the supply network:

- The water pressure should be between 1 and 10 bars (when the tap is turned on, at least 8 litres of water is discharged per minute).
- A pressure reducing valve must be installed if the maximum water pressure is exceeded.

Connect the water supply hose.

to the rear panel of the washing machine and ...

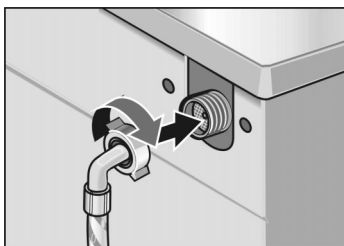

to the tap.

Subsequent to connection:
Turn on the water tap completely, and check connection points for water-tightness.

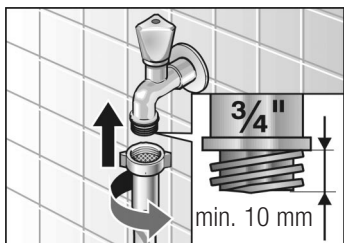

Water drainage

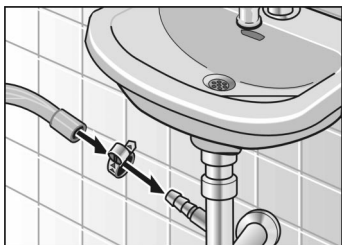

Caution

Do not bend or pull the water drainage hose.

Height difference between the placement area and drainage point: maximum 100 cm.

Drainage into a siphon:

- Secure the connection point with a hose band clip of 24–40 mm diameter (from specialist stores).

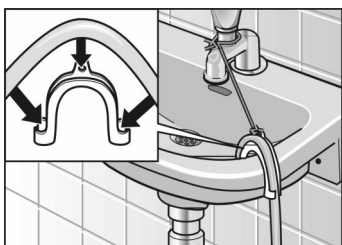

Drainage into a wash basin:

Caution

The plug must not block the drain of the wash basin.

- Secure the water drainage hose so that it does not slide out.
- When water is being drained, check that the water flow is fast enough.

Levelling procedure

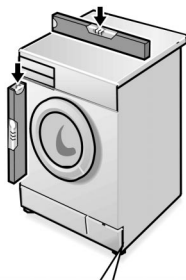

Align the washing machine with the aid of the four height-adjustable feet and a spirit level.

- Loosen lock nut **1** in a clockwise direction with a spanner.
- Adjust the height by rotating height-adjustable foot **2**.
- Tighten lock nut **1** against the housing; grip the foot and do not adjust the height.

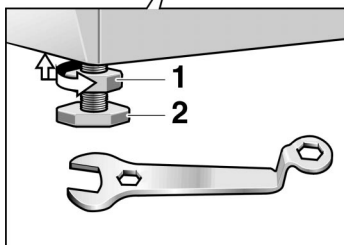

All four appliance feet must be situated firmly on the ground. The washing machine must not wobble. The lock nuts on all four appliance feet must be tightened against the housing.

Attention

Loud noises, vibrations and “wandering” may be due to incorrect alignment!

Electrical connection

Caution

The washing machine must only be connected to alternating current and using a properly installed socket outlet with earthing contact.

The mains voltage must correspond to the voltage specification on the washing machine (nameplate). Connection specifications as well as the required fuses are stipulated on the appliance nameplate.

Make sure that:

- the mains plug fits the socket outlet.
- the cable cross-section is permissible.
- the earthing system is properly installed.

The mains cable may be replaced by an electrician only.

Replacement mains cable available from customer service.

Do not use multiple plugs / connectors or extension cables.

In the event that an earth-leakage circuit breaker is to be used, only use types marked with the following symbol: .

Only this symbol can guarantee compliance with all current regulations.

Do not insert/pull out the mains plug with wet hands.

Do not pull out the mains plug by tugging the cable.

Transport, e.g. when moving

Before transporting the washing machine:

- Turn off the water tap.
- Release the water pressure in the supply hose (refer to Page 53).
- Drain any residual washing solution (refer to Page 52).
- Disconnect the washing machine from the mains.
- Detach the hoses.
- Install the lower 2 transport bolts.

Having transported the appliance and ensured proper installation and connection, allow the “Drain” programme to run through before starting the first wash programme.

Preparing and inserting the transport bolts

- Remove the 2 lower covers.
- Prepare the transport bolts:
Loosen the screw in the sleeve until the end of the screw is level with the end of the sleeve.
- Through the open washing machine door have a second person pull the top of the drum forwards and hold in this position.
Insert the transportation protection devices **1** and **2** and tighten the bolts. The washer lugs must be located in the groove in the rear panel of the housing.

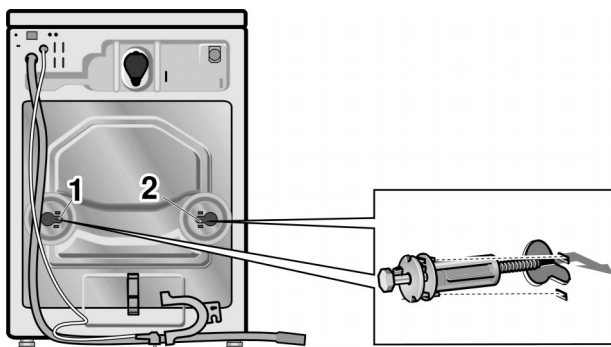

Additional guarantee

In addition to claims made under the guarantee against the seller in accordance with the contract of sale and in addition to our appliance warranty, we shall be liable for damages under the following circumstances:

- 1.** If water damage is caused by a fault in our water safety system, we shall make reparation for the damage with respect to private users.
- 2.** This liability guarantee is valid for the service life of the appliance.
- 3.** A claim can only be made under the guarantee provided the appliance has been correctly installed and connected in accordance with our instructions. Our guarantee does not apply to defective cables/hoses or to fittings up to the connection on the tap.
- 4.** Our appliances can be left unattended during operation. At the end of a wash programme always turn off the tap.

Free Manuals Download Website

<http://myh66.com>

<http://usermanuals.us>

<http://www.somanuals.com>

<http://www.4manuals.cc>

<http://www.manual-lib.com>

<http://www.404manual.com>

<http://www.luxmanual.com>

<http://aubethermostatmanual.com>

Golf course search by state

<http://golfingnear.com>

Email search by domain

<http://emailbydomain.com>

Auto manuals search

<http://auto.somanuals.com>

TV manuals search

<http://tv.somanuals.com>