



RS720Q-E9-RS24-S

2U Rackmount Server User Guide



Copyright © 2020 ASUSTeK COMPUTER INC. All Rights Reserved.

No part of this manual, including the products and software described in it, may be reproduced, transmitted, transcribed, stored in a retrieval system, or translated into any language in any form or by any means, except documentation kept by the purchaser for backup purposes, without the express written permission of ASUSTeK COMPUTER INC. ("ASUS").

ASUS provides this manual "as is" without warranty of any kind, either express or implied, including but not limited to the implied warranties or conditions of merchantability or fitness for a particular purpose. In no event shall ASUS, its directors, officers, employees, or agents be liable for any indirect, special, incidental, or consequential damages (including damages for loss of profits, loss of business, loss of use or data, interruption of business and the like), even if ASUS has been advised of the possibility of such damages arising from any defect or error in this manual or product.

Specifications and information contained in this manual are furnished for informational use only, and are subject to change at any time without notice, and should not be construed as a commitment by ASUS. ASUS assumes no responsibility or liability for any errors or inaccuracies that may appear in this manual, including the products and software described in it.

Product warranty or service will not be extended if: (1) the product is repaired, modified or altered, unless such repair, modification or alteration is authorized in writing by ASUS; or (2) the serial number of the product is defaced or missing.

Products and corporate names appearing in this manual may or may not be registered trademarks or copyrights of their respective companies, and are used only for identification or explanation and to the owners' benefit, without intent to infringe.

Contents

Notices	vii
REACH	vii
Safety information	viii
Australia statement notice.....	ix
About this guide	x
Chapter 1: Product Introduction	
1.1 System package contents	1-2
1.2 Serial number label	1-3
1.3 System specifications	1-4
1.4 Front panel features	1-6
1.5 Rear panel features	1-7
1.6 Internal features	1-8
1.7 LED information	1-9
1.7.1 Front panel LEDs	1-9
1.7.2 LAN (RJ-45) LEDs	1-10
1.7.3 HDD status LEDs.....	1-10
Chapter 2: Hardware Information	
2.1 Removing the server node	2-2
2.2 Air Duct	2-3
2.3 Central Processing Unit (CPU)	2-4
2.3.1 Installing the CPU and heatsink	2-4
2.4 System memory	2-7
2.4.1 Overview	2-7
2.4.2 Memory Configurations.....	2-7
2.5 Storage devices	2-9
2.6 Expansion slots	2-11
2.6.1 The PCI Express riser card.....	2-11
2.6.2 Installing Mezzanine cards.....	2-14
2.6.3 Configuring an expansion card	2-15
2.7 Backplane and Mid Plane cabling	2-16
2.8 Removable/optional components	2-18
2.8.1 System fan	2-18
2.8.2 Power supply module.....	2-20

Contents

- Chapter 3: Installation Options**
 - 3.1 Tool-less Friction Rail Kit.....3-2
 - 3.2 Rail kit dimensions3-4

- Chapter 4: Motherboard Information**
 - 4.1 Motherboard and Mid plane layout.....4-2
 - 4.1.1 Layout contents.....4-4
 - 4.2 Jumpers4-5
 - 4.3 Internal connectors4-11
 - 4.4 Internal LEDs.....4-14
 - 4.5 Mid Plane jumper4-16

- Chapter 5: BIOS Setup**
 - 5.1 Managing and updating your BIOS5-2
 - 5.1.1 ASUS CrashFree BIOS 3 utility.....5-2
 - 5.1.2 ASUS EZ Flash Utility5-3
 - 5.1.3 BUPDATER utility5-4
 - 5.2 BIOS setup program5-6
 - 5.2.1 BIOS menu screen.....5-7
 - 5.2.2 Menu bar5-7
 - 5.2.3 Menu items.....5-8
 - 5.2.4 Submenu items5-8
 - 5.2.5 Navigation keys.....5-8
 - 5.2.6 General help.....5-8
 - 5.2.7 Configuration fields5-8
 - 5.2.8 Pop-up window.....5-8
 - 5.2.9 Scroll bar5-8
 - 5.3 Main menu5-9
 - 5.3.1 System Date [Day xx/xx/xxxx].....5-9
 - 5.3.2 System Time [xx:xx:xx]5-9
 - 5.4 Performance Tuning menu.....5-10
 - 5.5 Advanced menu5-12
 - 5.5.1 Trusted Computing.....5-13
 - 5.5.2 ACPI Settings.....5-13
 - 5.5.3 Smart Settings.....5-13
 - 5.5.4 Super IO Configuration5-14
 - 5.5.5 Serial Port Console Redirection.....5-14

Contents

5.5.6	Onboard LAN Configuration.....	5-17
5.5.7	APM	5-18
5.5.8	PCI Subsystem Settings	5-19
5.5.9	Network Stack Configuration.....	5-23
5.5.10	CSM Configuration.....	5-24
5.5.11	NVMe Configuration.....	5-25
5.5.12	USB Configuration	5-25
5.5.13	Vcore Adjust.....	5-26
5.5.14	iSCSI Configuration	5-26
5.5.15	Intel(R) Virtual RAID on CPU.....	5-26
5.6	Platform Configuration menu	5-27
5.6.1	PCH Configuration	5-27
5.6.2	Miscellaneous Configuration	5-29
5.6.3	Server ME Configuration.....	5-29
5.6.4	Runtime Error Logging.....	5-30
5.7	Socket Configuration menu	5-31
5.7.1	Processor Configuration.....	5-31
5.7.2	Common RefCode Configuration.....	5-33
5.7.3	UPI Configuration.....	5-33
5.7.4	Memory Configuration.....	5-34
5.7.5	IIO Configuration	5-35
5.7.6	Advanced Power Management Configuration.....	5-36
5.8	Event Logs menu	5-38
5.8.1	Change Smbios Event Log Settings	5-38
5.8.2	View Smbios Event Log	5-38
5.9	Server Mgmt menu.....	5-39
5.9.1	System Event Log.....	5-39
5.9.2	BMC network configuration.....	5-40
5.9.3	View System Event Log	5-41
5.10	Security menu	5-42
5.11	Boot menu	5-45
5.12	Tool menu.....	5-46
5.13	Save & Exit menu.....	5-46

Contents

Chapter 6: RAID Configuration	
6.1	Setting up RAID..... 6-2
6.1.1	RAID definitions 6-2
6.1.2	Installing hard disk drives..... 6-2
6.1.3	RAID configuration utilities..... 6-2
6.2	Intel® Virtual Raid on CPU in BIOS..... 6-3
6.2.1	Creating a RAID set..... 6-4
6.2.2	Deleting a RAID set..... 6-5
6.3	Intel® Rapid Storage Technology enterprise (Windows)..... 6-6
6.3.1	Creating a RAID set..... 6-7
6.3.2	Changing a Volume Type..... 6-9
6.3.3	Deleting a volume 6-10
6.3.4	Preferences..... 6-11
Chapter 7: Driver Installation	
7.1	Intel RSTe RAID driver installation..... 7-2
7.1.1	Creating a USB flash drive with RAID driver..... 7-2
7.1.2	Installing the RAID controller driver..... 7-2
7.2	Management applications and utilities installation 7-5
7.3	Running the Support DVD..... 7-5
7.4	Intel® chipset device software installation 7-8
7.5	Installing the Intel® I350-AM2/I210 Gigabit Adapters driver 7-10
7.6	VGA driver installation 7-13
7.7	Intel® Rapid Storage Technology enterprise 5.0 installation..... 7-15
Appendix	
	Z11PH-D12 block diagram..... A-2
	ASUS contact information..... A-3

Notices

Federal Communications Commission Statement

This device complies with Part 15 of the FCC Rules. Operation is subject to the following two conditions:

- This device may not cause harmful interference, and
- This device must accept any interference received including interference that may cause undesired operation.

This equipment has been tested and found to comply with the limits for a Class A digital device, pursuant to part 15 of the FCC Rules. These limits are designed to provide reasonable protection against harmful interference when the equipment is operated in a commercial environment. This equipment generates, uses, and can radiate radio frequency energy and, if not installed and used in accordance with the instruction manual, may cause harmful interference to radio communications. Operation of this equipment in a residential area is likely to cause harmful interference in which case the user will be required to correct the interference at his own expense.



The use of shielded cables for connection of the monitor to the graphics card is required to assure compliance with FCC regulations. Changes or modifications to this unit not expressly approved by the party responsible for compliance could void the user's authority to operate this equipment.

Compliance Statement of Innovation, Science and Economic Development Canada (ISED)

This device complies with Innovation, Science and Economic Development Canada licence exempt RSS standard(s). Operation is subject to the following two conditions: (1) this device may not cause interference, and (2) this device must accept any interference, including interference that may cause undesired operation of the device.

CAN ICES-3(A)/NMB-3(A)

Déclaration de conformité de Innovation, Sciences et Développement économique Canada (ISED)

Le présent appareil est conforme aux CNR d'Innovation, Sciences et Développement économique Canada applicables aux appareils radio exempts de licence. L'exploitation est autorisée aux deux conditions suivantes : (1) l'appareil ne doit pas produire de brouillage, et (2) l'utilisateur de l'appareil doit accepter tout brouillage radioélectrique subi, même si le brouillage est susceptible d'en compromettre le fonctionnement.

CAN ICES-3(A)/NMB-3(A)

REACH

Complying with the REACH (Registration, Evaluation, Authorization, and Restriction of Chemicals) regulatory framework, we publish the chemical substances in our products at ASUS REACH website at <http://csr.asus.com/english/REACH.htm>.

Safety information

Electrical Safety

- Before installing or removing signal cables, ensure that the power cables for the system unit and all attached devices are unplugged.
- To prevent electrical shock hazard, disconnect the power cable from the electrical outlet before relocating the system.
- When adding or removing any additional devices to or from the system, ensure that the power cables for the devices are unplugged before the signal cables are connected. If possible, disconnect all power cables from the existing system before you add a device.
- If the power supply is broken, do not try to fix it by yourself. Contact a qualified service technician or your dealer.

Operation Safety

- Any mechanical operation on this server must be conducted by certified or experienced engineers.
- Before operating the server, carefully read all the manuals included with the server package.
- Before using the server, ensure all cables are correctly connected and the power cables are not damaged. If any damage is detected, contact your dealer as soon as possible.
- To avoid short circuits, keep paper clips, screws, and staples away from connectors, slots, sockets and circuitry.
- Avoid dust, humidity, and temperature extremes. Place the server on a stable surface.



This product is equipped with a three-wire power cable and plug for the user's safety. Use the power cable with a properly grounded electrical outlet to avoid electrical shock.

Lithium-Ion Battery Warning

CAUTION! Danger of explosion if battery is incorrectly replaced. Replace only with the same or equivalent type recommended by the manufacturer. Dispose of used batteries according to the manufacturer's instructions.

CLASS 1 LASER PRODUCT

Heavy System

CAUTION! This server system is heavy. Ask for assistance when moving or carrying the system.



DO NOT throw the motherboard in municipal waste. This product has been designed to enable proper reuse of parts and recycling. This symbol of the crossed out wheeled bin indicates that the product (electrical and electronic equipment) should not be placed in municipal waste. Check local regulations for disposal of electronic products.



DO NOT throw the mercury-containing button cell battery in municipal waste. This symbol of the crossed out wheeled bin indicates that the battery should not be placed in municipal waste.

Australia statement notice

From 1 January 2012 updated warranties apply to all ASUS products, consistent with the Australian Consumer Law. For the latest product warranty details please visit <https://www.asus.com/support>. Our goods come with guarantees that cannot be excluded under the Australian Consumer Law. You are entitled to a replacement or refund for a major failure and compensation for any other reasonably foreseeable loss or damage. You are also entitled to have the goods repaired or replaced if the goods fail to be of acceptable quality and the failure does not amount to a major failure.

If you require assistance please call ASUS Customer Service 1300 2787 88 or visit us at <https://www.asus.com/support>

About this guide

Audience

This user guide is intended for system integrators, and experienced users with at least basic knowledge of configuring a server.

Contents

This guide contains the following parts:

1. Chapter 1: Product Introduction

This chapter describes the general features of the server, including sections on front panel and rear panel specifications.

2. Chapter 2: Hardware Information

This chapter lists the hardware setup procedures that you have to perform when installing or removing system components.

3. Chapter 3: Installation Options

This chapter describes how to install optional components into the barebone server.

4. Chapter 4: Motherboard Information

This chapter gives information about the motherboard that comes with the server. This chapter includes the motherboard layout, jumper settings, and connector locations.

5. Chapter 5: BIOS Information

This chapter tells how to change system settings through the BIOS Setup menus and describes the BIOS parameters.

6. Chapter 6: RAID Configuration

This chapter tells how to change system settings through the BIOS Setup menus. Detailed descriptions of the BIOS parameters are also provided.

7. Chapter 7: Driver Installation

This chapter provides instructions for installing the necessary drivers for different system components.

Conventions

To ensure that you perform certain tasks properly, take note of the following symbols used throughout this manual.



DANGER/WARNING: Information to prevent injury to yourself when trying to complete a task.



CAUTION: Information to prevent damage to the components when trying to complete a task.



IMPORTANT: Instructions that you **MUST** follow to complete a task.



NOTE: Tips and additional information to help you complete a task.

Typography

Bold text

Indicates a menu or an item to select.

Italics

Used to emphasize a word or a phrase.

<Key>

Keys enclosed in the less-than and greater-than sign means that you must press the enclosed key.

Example: <Enter> means that you must press the Enter or Return key.

<Key1>+<Key2>+<Key3>

If you must press two or more keys simultaneously, the key names are linked with a plus sign (+).

Example: <Ctrl>+<Alt>+

Command

Means that you must type the command exactly as shown, then supply the required item or value enclosed in brackets.

Example: At the DOS prompt, type the command line: **format A:/S**

References

Refer to the following sources for additional information, and for product and software updates.

1. **ASUS Control Center (ACC) user guide**

This manual tells how to set up and use the proprietary ASUS server management utility. Visit asuscontrolcenter.asus.com for more information.

2. **ASUS websites**

The ASUS websites worldwide provide updated information for all ASUS hardware and software products. Refer to the ASUS contact information.

Product Introduction

1

This chapter describes the general features of the chassis kit. It includes sections on front panel and rear panel specifications.

1.1 System package contents

Check your system package for the following items.

Model Name	RS720Q-E9-RS24-S
Chassis	ASUS 2U Rackmount Chassis
Motherboard	ASUS Z11PH-D12 Server Board
Component	2 x 1600/2200W Power Supply
	4 x PCIe Riser Card (RE16L-R21L)
	2 x Front Panel Board (LED Board, FPB-R2H-A)
	2 x Power Supply Distribution Board (PDB-R2H-A)
	1 x Power Connection Board (PSB-R2H-A)
	1 x Backplane Board (BP8LE16LX12G-25-R2H-A)
	2 x Midplane Board (MP4LE16LX12G-R2H-A)
	2 x Back plane Fans (40mm x 28mm)
	4 x System Fans (80mm x 38mm)
	24 x Hot-swap 2.5" Storage Bays
	1 x ASUS RS720Q-E9-RS24-S Series Support DVD (includes User Guide)
	8 x CPU Heatsinks
	1 x Bag of Screws
Accessories	2 x AC Power Cables
	1 x Friction Rail Kit
	8 x LGA3647-P0 NRW-NF-CPU Carrier (Barebone)
	4 x LGA3647-P0 NRW-F-CPU Carrier (Barebone)



If any of the above items is damaged or missing, contact your retailer.

1.2 Serial number label

Please take note of the product's serial number. The Serial number contains 12 characters such as xxS0xxxxxxxx similar to the figure shown below.

You need to provide the correct serial number to the ASUS Technical Support team member if you need assistance or, when requesting support.



1.3 System specifications

The ASUS RS720Q-E9-RS24-S Series is a 2U server system featuring the ASUS Z11PH-D12 Server Board. The server supports Intel® Xeon® processor Scalable family plus other latest technologies through the chipsets onboard.

Model Name		RS720Q-E9-RS24-S
Processor Support / System Bus		2 x Socket P0 (LGA 3647) per Node 1st Gen Intel® Xeon® processor Scalable family (Up to 165W) 2nd Gen Intel® Xeon® processor Scalable family (Up to 165W) UPI 10.4 GT/s
Core Logic		Intel® C621 PCH
ASUS Features	Fan Speed Control	✓
	ASWM Enterprise	✓
Memory	Total Slots	12 (6-channel per CPU, 6 DIMM per CPU)
	Capacity	Maximum up to 3072GB
	Memory Type	DDR4 2933 (1 DIMM per Channel)
		DDR4 2666 / 2400 / 2133 RDIMM / LR-DIMM / LR-DIMM 3DS * 2933MHz will drop to 2666MHz when using 2DPC configurations. * Refer to ASUS server AVL for the latest update
	Memory Size	4GB, 8GB, 12GB, 32GB (RDIMM)
64GB, 128GB (RDIMM 3DS)		
32GB, 64GB, 128GB (LRDIMM) 64GB, 128GB, 256GB (LRDIMM 3DS) * Refer to ASUS server AVL for the latest update		
Expansion Slots	Total PCI/PCI-E Slots	1+1 per node
	Slot Type	Per Node: 1 x PCI-E x16 (Gen3 x16 link), LP, HL 1 x OCP 2.0 Mezzanine (Gen3 x16 link)
Storage	SATA Controller	Per Mid Plane: LSI SAS3008 - 8 x SATA 6Gb/s ports (by 2 Oculink Connectors) - 2 x Oculink ports LSI RAID (Support hardware RAID 0, 1, 10) Intel® VROC (for Windows only; Support software RAID 0, 1, 10 & 5)
		SAS Upgrade

(continued on the next page)

Model Name		RS720Q-E9-RS24-S
HDD Bays		24 x 2.5" Hot-swap Storage Bays (8 NVMe Supported)
Networking	LAN	Per Node: 1 x Dual Port Intel I350-AM2 Gigabit LAN controller 1 x Management Port
	VGA	Aspeed AST2500 64MB
Graphic		Aspeed AST2500 64MB
Rear I/O Connectors		Per Node: 2 x USB 3.0 ports 1 x VGA port 2 x RJ-45 GbE LAN ports 1 x RJ-45 Mgmt LAN port
Switch/LED		Per Node: Rear Switch/LED: 1 x Q-Code/Port 80 LED 1 x Power switch LED Front Switch/LED: 1 x Power switch/LED 1 x Location switch/LED 1 x Message LED LAN 1-2 LED
Management Solution	Software	ASUS Control Center (Classic)
	Out of Band Remote Management	On-Board ASMB9-iKVM for KVM-over-IP
OS support		Please find the latest OS support from http://www.asus.com/
Regulatory Compliance		BSMI, CE, C-TICK, FCC (ClassA)
Dimension		800mm x 444mm x 88mm(2U) 31.5" x 17.48" x 3.46"
Gross Weight Kg		41.5 kg
Net Weight Kg (CPU, DRAM, and HDD not included)		32.5 kg
Power Supply (following different configuration by region)		1+1 Redundant 1600/2200W 80 PLUS Platinum Power Supply Rating: 200-240Vac, 9.5A (for each inlet), 47-63Hz, Class I
Environment		Operation temperature: 10° ~ 35° Operation temperature (for 165W CPU): 10° ~ 30° Non operation temperature: -40° ~ 60° Non operation humidity: 20% ~ 90% (Non condensing)



Specifications are subject to change without notice.

1.4 Front panel features

The barebone server displays easily accessible features such as the power and reset buttons, LED indicators, and optical drive.



Refer to the **Front panel LEDs** section for the LED descriptions.

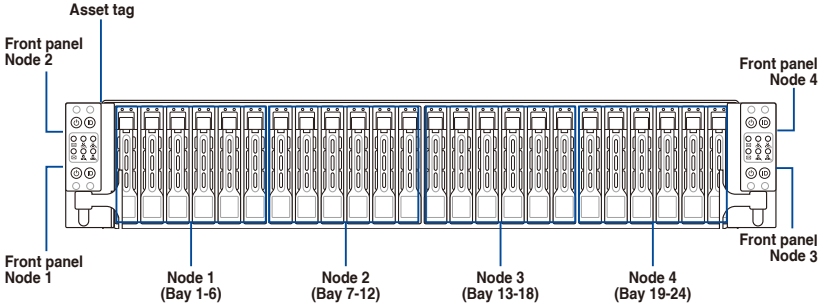

Turn off the system power and detach the power supply before removing or replacing any system component.

Asset tag

The Asset tag is a small polyester film located to the right side of the server's front right panel. It provides information about the server such as asset barcode or serial number and is useful in asset tracking and inventory management.

1.5 Rear panel features

RS720Q-E9-RS24-S

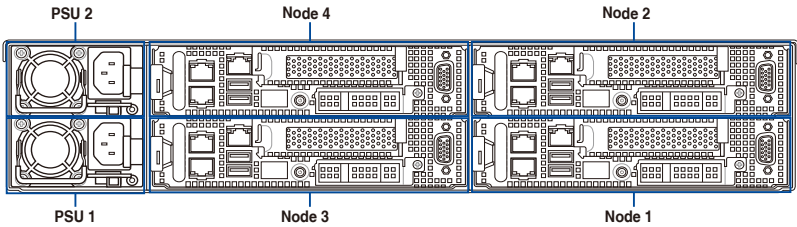

When installing only two nodes, install the nodes to node slot number 1 and 3 or number 2 and 4.

Z11PH-D12 (Node)

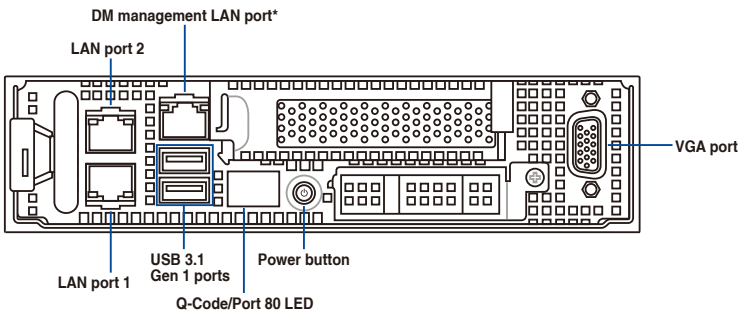

* This port is for ASUS ASMB9-iKVM controller and for technicians only.

1.6 Internal features

The barebone server includes the basic components as shown.

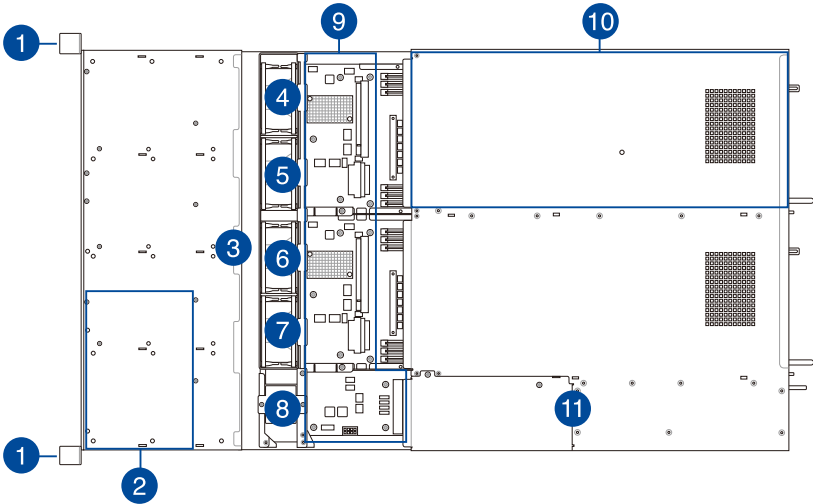

1. Front LED Boards
2. Hot-swap storage device trays
3. Backplane
4. System fan (SYS_FAN1)
5. System fan (SYS_FAN2)
6. System fan (SYS_FAN3)
7. System fan (SYS_FAN4)
8. BP_FAN1 (top) and BP_FAN2 (bottom)
9. SATA/SAS/NVMe Mid-plane
10. ASUS Z11PH-D12 Server Board
11. Power supply and power fan



Ensure that the air duct is positioned on the gaps between the memory slots.





Turn off the system power and detach the power supply before removing or replacing any system component.

***WARNING**
HAZARDOUS MOVING PARTS
KEEP FINGERS AND OTHER BODY PARTS AWAY

1.7 LED information

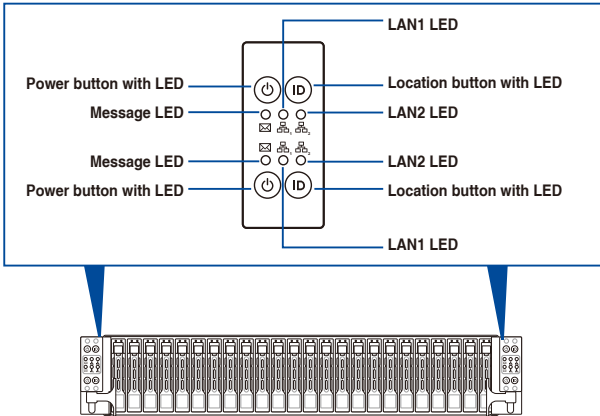
1.7.1 Front panel LEDs



LED	Icon	Display status	Description
Power LED	💡	ON	System power ON
Message LED	✉	OFF	System is normal; no incoming event
		ON	A hardware monitor event is indicated
LAN LEDs		OFF	No LAN connection
		Blinking	LAN is transmitting or receiving data
		ON	LAN connection is present
Location LED	ID	ON	Location switched is pressed
		OFF	Normal status (Press the location switch again to turn off.)

1.7.2 LAN (RJ-45) LEDs

LAN port LED indications

Activity/Link LED		Speed LED	
Status	Description	Status	Description
OFF	No link	OFF	10 Mbps connection
GREEN	Linked	ORANGE	100 Mbps connection
BLINKING	Data activity	GREEN	1 Gbps connection

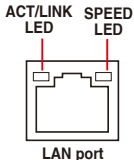

The diagram shows a standard RJ-45 LAN port. Two LEDs are located above the port: the left one is labeled 'ACT/LINK LED' and the right one is labeled 'SPEED LED'. The port itself is labeled 'LAN port'.

1.7.3 HDD status LEDs

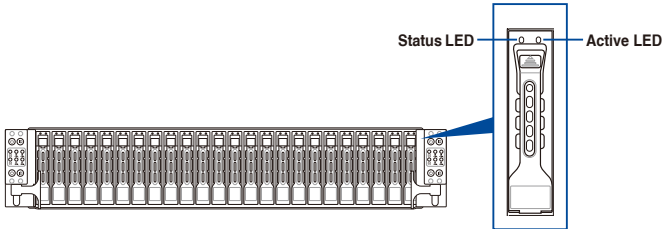

HDD LED	Description		
HDD Activity LED (Green)	OFF	HDD not present	
	ON	HDD present, no activity	
	Blinking	1. Read/write data from/into the storage device 2. Locating (blinking with the HDD status LED)	
HDD Status LED	GREEN	ON	Storage device power ON
	RED	ON	HDD has failed and should be swapped immediately
	GREEN/ RED	Blinking	RAID rebuilding
	GREEN/ RED	OFF	HDD not found

1.7.4 Q-Code table

Action	PHASE	POST CODE	TYPE	DESCRIPTION
Normal boot	Security Phase	01	Progress	First post code(POWER_ON_POST_CODE)
		02	Progress	Load BSP microcode(MICROCODE_POST_CODE)
		03	Progress	Set cache as ram for PEI phase(CACHE_ENABLED_POST_CODE)
		06	Progress	CPU Early init.(CPU_EARLY_INIT_POST_CODE)
		04	Progress	initializes South bridge for PEI preparation
	PEI(Pre-EFI initialization) phase	10	Progress	PEI Core Entry
		15	Progress	NB initialize before installed memory
		19	Progress	SB initialize before installed memory
		78-00	Progress	Wait BMC ready(duration: 120 seconds).
		A1	MRC Progress	QPI initialization
		A3	MRC Progress	QPI initialization
		A7	MRC Progress	QPI initialization
		A8	MRC Progress	QPI initialization
		A9	MRC Progress	QPI initialization
		AA	MRC Progress	QPI initialization
		AB	MRC Progress	QPI initialization
		AC	MRC Progress	QPI initialization
		AD	MRC Progress	QPI initialization
		AE	MRC Progress	QPI initialization
		AF	MRC Progress	QPI initialization Complete
		2F	Progress	Memory Init.
		B0	MRC Progress	Memory Init.
		B1	MRC Progress	Memory Init.
		AF	MRC Progress	RC Reset if require
		B4	MRC Progress	Memory Init.
		B2	MRC Progress	Memory Init.
		B3	MRC Progress	Memory Init.
		B5	MRC Progress	Memory Init.
		B6	MRC Progress	Memory Init.
		B7	MRC Progress	Memory Init.
		B8	MRC Progress	Memory Init.
		B9	MRC Progress	Memory Init.
		BA	MRC Progress	Memory Init.
		BB	MRC Progress	Memory Init.
		BC	MRC Progress	Memory Init.
		BF	MRC Progress	Memory Init. Done
		5A	MRC Progress	Other config. After RC end
		31	Progress	Memory already installed.
		32	Progress	CPU Init.
		34	Progress	CPU Init.
		36	Progress	CPU Init.
		4F	Progress	DXE Initial Program Load(IPL)

(continued on the next page)

Q-Code table

Action	PHASE	POST CODE	TYPE	DESCRIPTION
Normal boot	DXE(Driver Execution Environment) phase	60	Progress	DXE Core Started
		61	Progress	DXE NVRAM Init.
		62	Progress	SB run-time init.
		63	Progress	DXE CPU Init
		68	Progress	NB Init.
		69	Progress	NB Init.
		6A	Progress	NB Init.
		70	Progress	SB Init.
		71	Progress	SB Init.
		72	Progress	SB Init.
	78	Progress	ACPI Init.	
	79	Progress	CSM Init.	
	BDS(Boot Device Selection) phase	90	Progress	BDS started
		91	Progress	Connect device event
		92	Progress	PCI Bus Enumeration.
		93	Progress	PCI Bus Enumeration.
		94	Progress	PCI Bus Enumeration.
		95	Progress	PCI Bus Enumeration.
		96	Progress	PCI Bus Enumeration.
		97	Progress	Console output connect event
		98	Progress	Console input connect event
		99	Progress	AMI Super IO start
		9A	Progress	AMI USB Driver Init.
		9B	Progress	AMI USB Driver Init.
		9C	Progress	AMI USB Driver Init.
		9D	Progress	AMI USB Driver Init.
		b2	Progress	Legacy Option ROM Init.
		b3	Progress	Reset system
		b4	Progress	USB hotplug
		b6	Progress	NVRAM clean up
		b7	Progress	NVRAM configuration reset
		A0	Progress	IDE, AHCI Init.
		A1	Progress	IDE, AHCI Init.
		A2	Progress	IDE, AHCI Init.
		A3	Progress	IDE, AHCI Init.
		A8	Progress	BIOS Setup Utility password verify
		A9	Progress	BIOS Setup Utility start
		AB	Progress	BIOS Setup Utility input wait
		AD	Progress	Ready to boot event
		AE	Progress	Legacy boot event
	Operating system phase	AA	Progress	APIC mode
		AC	Progress	PIC mode

Hardware Information

2

This chapter lists the hardware setup procedures that you have to perform when installing or removing system components.

2.1 Removing the server node

1. Remove the screw located on the node latch.

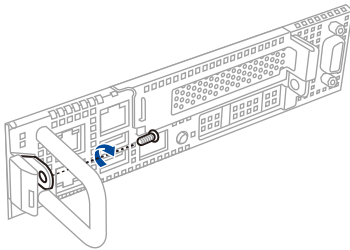

2. Hold the server node lever and press the green node latch.

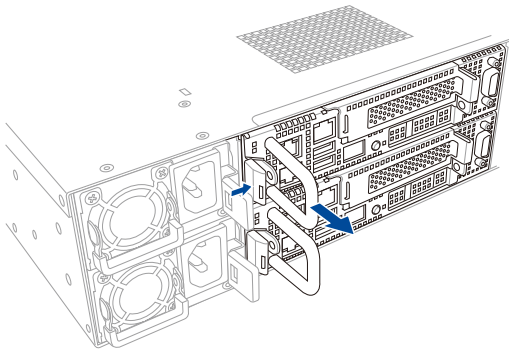

3. Firmly pull the server node out of the server chassis.

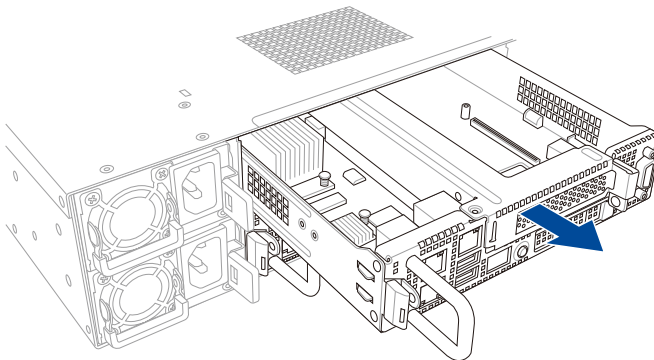

When installing only two nodes, install the nodes to node slot number 1 and 3 or number 2 and 4. Refer to section 1.5 **Rear panel features** for details.

2.2 Air Duct

The RS720Q-E9-RS24-S series server system comes with a motherboard fan air duct to enable better air flow inside the motherboard while the system is running.

Removing the air duct

1. Remove the screws securing the air duct in place.
2. Carefully lift the air duct out of the chassis.

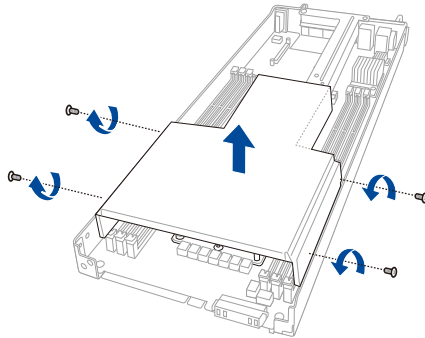

Installing the air duct

Position the air duct on top of the motherboard then carefully fit it on top of the motherboard. Refer to the following illustration for the right orientation of the air duct.



Insert the air duct on the gaps between the memory slots.



Ensure that the air duct is firmly fitted to the motherboard.

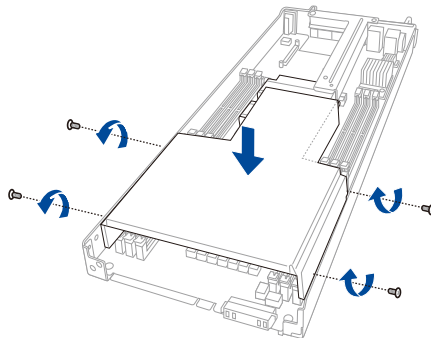

2.3 Central Processing Unit (CPU)

The motherboard comes with a surface mount LGA 3647 socket designed for the Intel® Xeon® Skylake-F/SP product family series processors.



- Upon purchase of the system, ensure that the PnP cap is on the socket and the socket contacts are not bent. Contact your retailer immediately if the PnP cap is missing, or if you see any damage to the PnP cap/socket contacts/motherboard components. ASUS will shoulder the cost of repair only if the damage is shipment/transit-related.
- The product warranty does not cover damage to the socket contacts resulting from incorrect CPU installation/removal, or misplacement/loss/incorrect removal of the PnP cap.

2.3.1 Installing the CPU and heatsink

To install a CPU:

1. Remove the server node. For more information, see the section **Removing the server node**.
2. Remove the air duct. For more information, see the section **Air Duct**.
3. Remove the PnP caps from the CPU sockets.

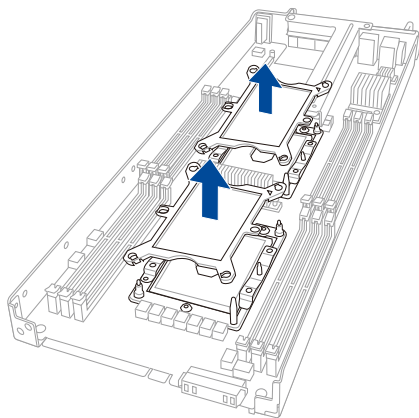

- Align the triangle mark on the CPU with the triangle mark on the CPU Carrier (A), install the CPU into the CPU Carrier until it clicks firmly into place (B), and then install the CPU Carrier into the heatsink until it clicks firmly into place (C).



- The CPU carrier varies between CPUs, ensure to use the correct CPU carrier for the corresponding CPU.
- Ensure that the triangle mark on the CPU matches the triangle mark on the CPU Carrier.

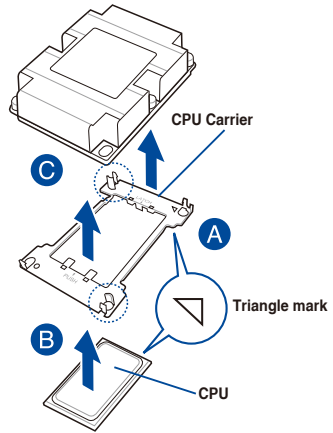

- Align the CPU and CPU Carrier in the correct orientation, and then place the heatsinks on top of the CPU sockets.



The CPU and CPU Carrier fits in only one correct orientation. DO NOT force the CPU and CPU Carrier into the socket to prevent damaging the CPU pins on the socket.



The heatsink for RS720Q-E9-RS24-S Series differs between CPU1 and CPU2, please refer to the illustration below for more information on the heatsink and the corresponding CPU socket.

Z11PH-D12 CPU LGA 3647 Socket

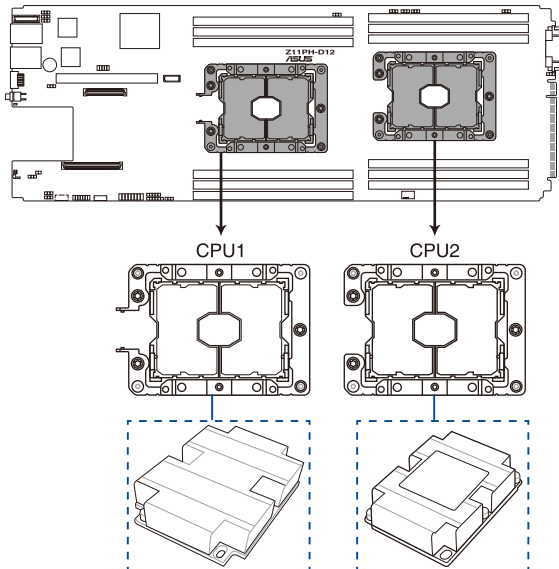

6. Twist each of the four screws with a screwdriver just enough to attach the heatsink to the motherboard. When the four screws are attached, tighten them one by one in the sequence 1, 2 then 3, 4 as shown on the heatsink to completely secure the heatsink.



-
- The heatsink screws are T30 models. A torque value of 12 inch-lbf is recommended.
 - When uninstalling the heatsink ensure to loosen the four screws in the sequence 3, 4 then 1, 2 as shown on the heatsink.
-

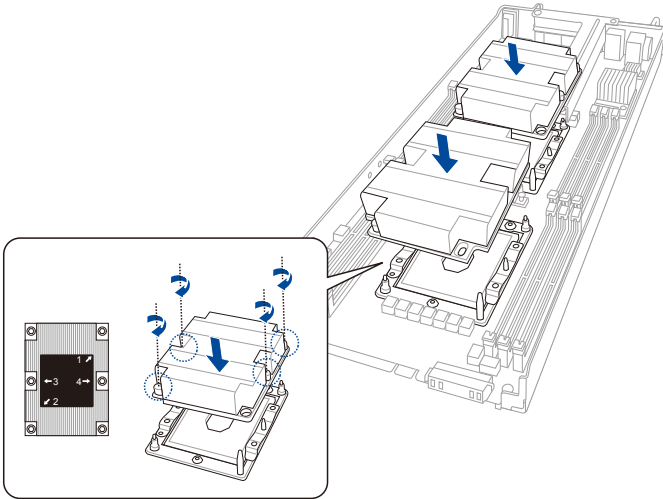

7. Reinstall the air duct. For more information, see the section **Air Duct**.

2.4 System memory

2.4.1 Overview

The motherboard comes with twelve (12) Double Data Rate 4 (DDR4) Dual Inline Memory Modules (DIMM) sockets.

The figure illustrates the location of the DDR4 DIMM sockets:

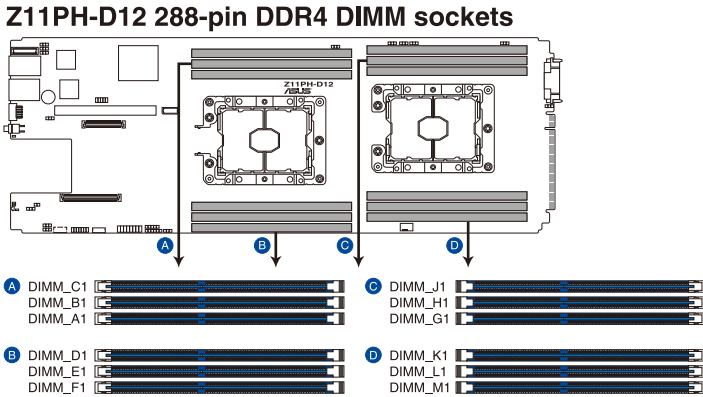

2.4.2 Memory Configurations

You may install 4GB, 8GB, 12GB, and 32GB RDIMMs; or 64GB, and 128GB RDIMMs (3DS); or 32GB, 64GB, and 128GB LRDIMMs; or 64GB, 128GB, and 256GB LRDIMMs (3DS); or 128GB, 256GB, and 512GB DCPMMs into the DIMM sockets using the memory configurations in this section.



- Refer to ASUS Server AVL for the updated list of compatible DIMMs.
- Always install DIMMs with the same CAS latency. For optimum compatibility, it is recommended that you obtain memory modules from the same vendor.

Dual CPU configuration												
	A1	B1	C1	D1	E1	F1	G1	H1	J1	K1	L1	M1
2 DIMMs	✓						✓					
4 DIMMs	✓			✓			✓			✓		
8 DIMMs	✓	✓		✓	✓		✓	✓		✓	✓	
12 DIMMs	✓	✓	✓	✓	✓	✓	✓	✓	✓	✓	✓	✓

2.4.3 Installing a DIMM on a single clip DIMM socket

1. Unlock a DIMM socket by pressing the retaining clip outward.
2. Align a DIMM on the socket such that the notch on the DIMM matches the DIMM slot key on the socket.

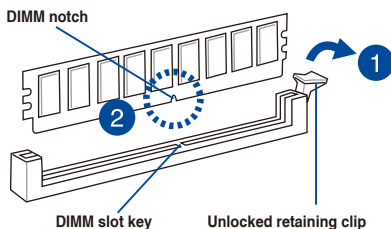

A DIMM is keyed with a notch so that it fits in only one direction. **DO NOT** force a DIMM into a socket in the wrong direction to avoid damaging the DIMM.

3. Hold the DIMM by both of its ends, then insert the DIMM vertically into the socket. Apply force to both ends of the DIMM simultaneously until the retaining clip snaps back into place, and the DIMM cannot be pushed in any further to ensure proper sitting of the DIMM.

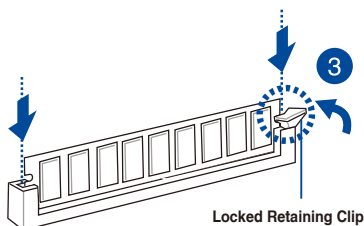

Always insert the DIMM into the socket **VERTICALLY** to prevent DIMM notch damage.



- To install two or more DIMMs, refer to the user guide bundled in the motherboard package.
- Refer to www.asus.com for qualified vendor lists of the memory modules.

Removing a DIMM from a single clip DIMM socket

1. Press the retaining clip outward to unlock the DIMM.
2. Remove the DIMM from the socket.

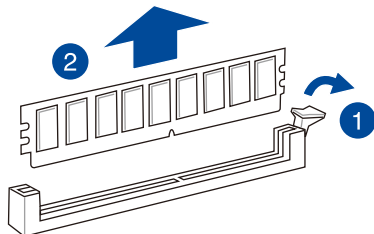

Support the DIMM lightly with your fingers when pressing the retaining clips. The DIMM might get damaged when it flips out with extra force.

2.5 Storage devices

The system supports six (6) hot-swap storage devices per node. The storage device installed on the drive tray connects to the Mid Plane via the backplane.

To install a hot-swap storage device:



Ensure that the storage devices installed correspond to the correct node. For more information on the nodes and the storage bays, please refer to **1.4 Front panel features** and **1.5 Rear panel features**.

1. Press the spring lock to release the tray lever and to partially eject the tray from the bay.
2. Firmly hold the tray lever and carefully pull the drive tray out of the bay. Place the drive tray in a clean and flat surface.

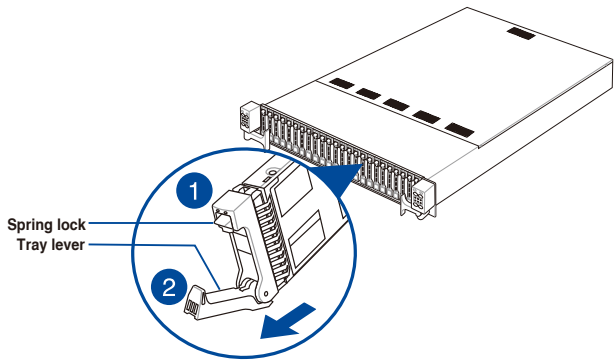

3. Release the screws on each side of the drive tray to release the drive tray metal beam.



The drive tray metal beam provides horizontal support to the empty drive tray and prevents the drive tray from being bent or deformed.

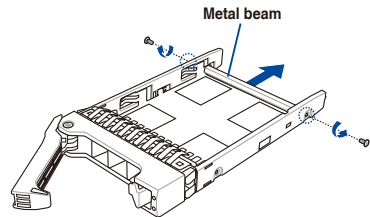

4. Orient and place the storage device into the tray. Ensure that the storage device is fitted firmly inside the drive tray and that the four screws of the storage device matches the four screw holes of the drive tray.

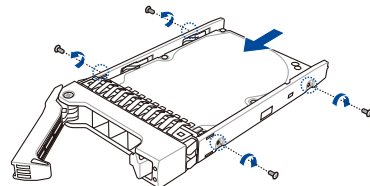

5. Align and insert the 2.5-inch storage device and drive tray assembly into the drive bay.

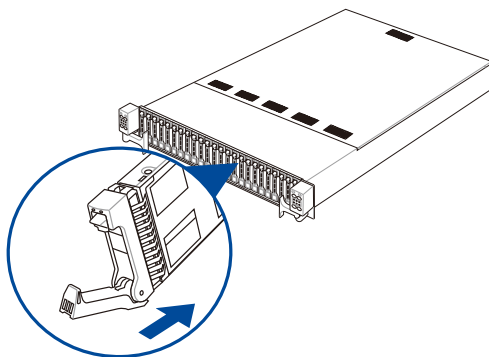

6. Repeat steps 1-6 to install the other 2.5-inch storage devices.

2.6 Expansion slots

The following subsections describe the slots and expansion cards that they support.



Ensure to unplug the power cord before adding or removing expansion cards. Failure to do so may cause you physical injury and damage motherboard components.

2.6.1 The PCI Express riser card

The onboard PCI Express slot on the motherboard comes pre-installed with a riser card that supports one x16 slot (Gen3 x16 link) for installing PCI-E x16 low profile cards.

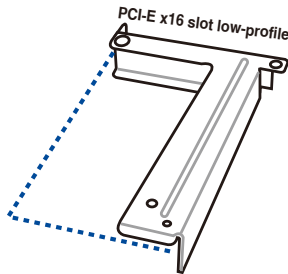

To install PCI-E expansion cards to the riser card:

1. Remove the screw securing the riser card to the chassis.
2. Firmly hold the riser card then pull it up to detach it from the PCI Express x16 slot on the motherboard.



Ensure to remove the riser card from the air duct when removing the riser card.

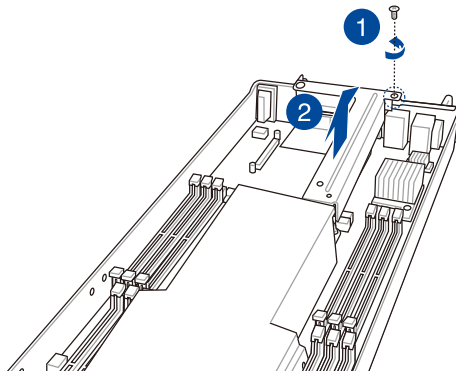

3. Remove the screw from the metal bracket on the riser card, then remove the metal brackets from the riser card.

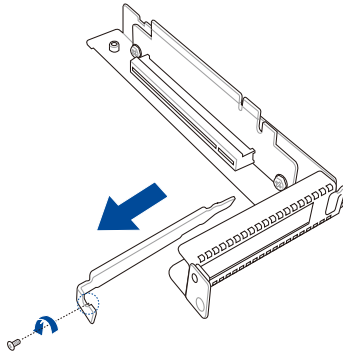

4. Prepare the expansion card.



Before installing an expansion card, read the documentation that came with it and ensure to make the necessary hardware settings.

5. Align and insert the golden finger connectors of the expansion card to the PCI-E slot connector on the riser card as shown.
6. Secure the expansion card with the screws removed earlier.

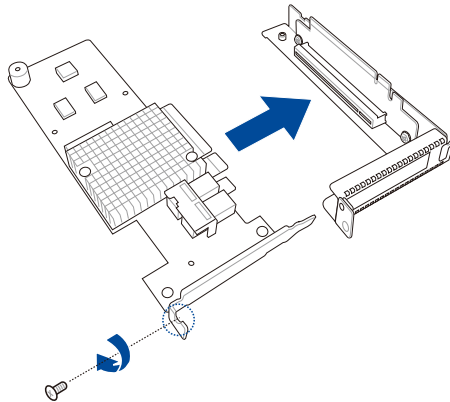

7. Align and insert the riser card and expansion card assembly into the PCI-E slot on the motherboard.



The expansion card fits in one orientation only. If it does not fit, try reversing it.

8. Secure the riser card with the screw that you removed earlier in step 1.

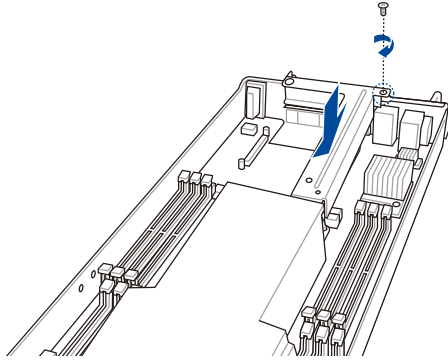

2.6.2 Installing Mezzanine cards

To install a Mezzanine card:

1. Locate a Mezzanine card connector on your motherboard.

Z11PH-D12 MEZZPCIE connectors

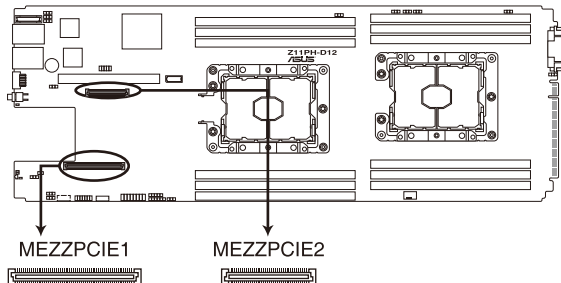

2. Prepare the Mezzanine card.
3. Insert the port of the Mezzanine card into the mounting hole on the chassis then insert the golden connector of the Mezzanine card into the OCP connector on the motherboard.

Ensure that the stand screws on the motherboard is aligned and matched to the screw holes of the Mezzanine card.

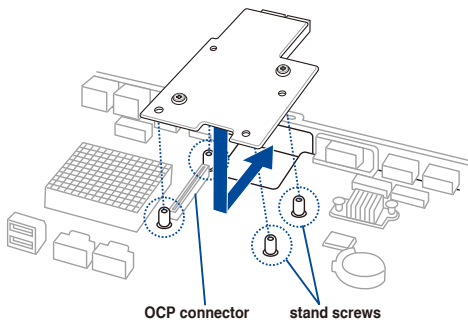

4. Secure the Mezzanine card with four bundled screws.

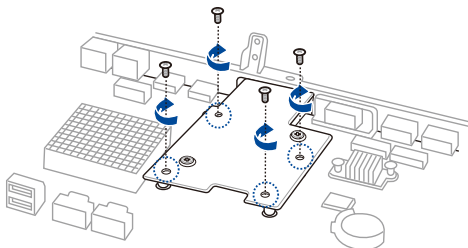

2.6.3 Configuring an expansion card

After installing the expansion card, configure it by adjusting the software settings.

1. Turn on the system and change the necessary BIOS settings, if any. See Chapter 5 for information on BIOS setup.
2. Assign an IRQ to the card. Refer to the **Standard Interrupt assignments** table for more information.
3. Install the software drivers for the expansion card.

Standard Interrupt assignments

IRQ	Priority	Standard function
0	1	System Timer
1	2	Keyboard Controller
2	-	Programmable Interrupt
3*	11	Communications Port (COM2)
4*	12	Communications Port (COM1)
5*	13	--
6	14	Floppy Disk Controller
7*	15	--
8	3	System CMOS/Real Time Clock
9*	4	ACPI Mode when used
10*	5	IRQ Holder for PCI Steering
11*	6	IRQ Holder for PCI Steering
12*	7	PS/2 Compatible Mouse Port
13	8	Numeric Data Processor
14*	9	Primary IDE Channel
15*	10	Secondary IDE Channel

* These IRQs are usually available for ISA or PCI devices.

2.7 Backplane and Mid Plane cabling

RS720Q-E9-RS24-S

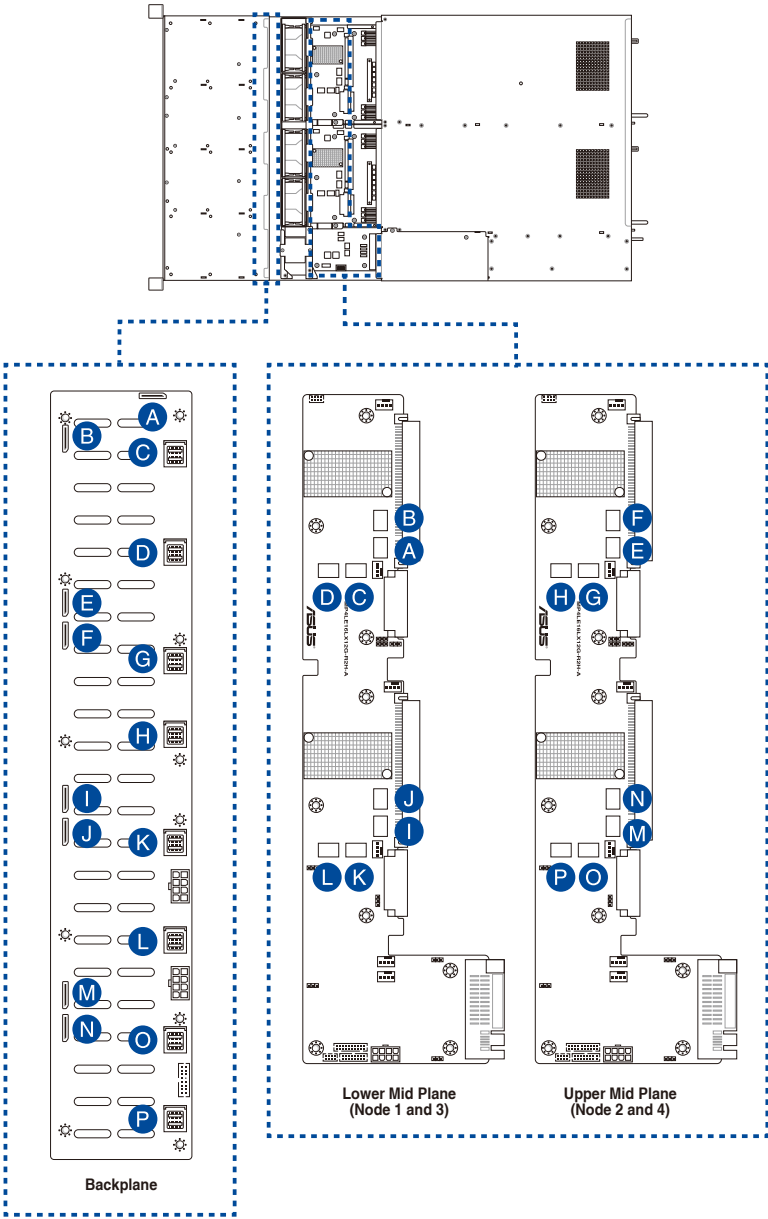

A	Connect N1_OCUPCIE1 on the Backplane to N1_OCUPCIE1 on the Lower Mid Plane
B	Connect N1_OCUPCIE2 on the Backplane to N1_OCUPCIE2 on the Lower Mid Plane
C	Connect N1_MSASHD1 on the Backplane to N1_OCUSAS1 on the Lower Mid Plane
D	Connect N1_MSASHD2 on the Backplane to N1_OCUSAS2 on the Lower Mid Plane
E	Connect N2_OCUPCIE1 on the Backplane to N2_OCUPCIE1 on the Upper Mid Plane
F	Connect N2_OCUPCIE2 on the Backplane to N2_OCUPCIE2 on the Upper Mid Plane
G	Connect N2_MSASHD1 on the Backplane to N2_OCUSAS1 on the Upper Mid Plane
H	Connect N2_MSASHD2 on the Backplane to N2_OCUSAS2 on the Upper Mid Plane
I	Connect N3_OCUPCIE1 on the Backplane to N3_OCUPCIE1 on the Lower Mid Plane
J	Connect N3_OCUPCIE2 on the Backplane to N3_OCUPCIE2 on the Lower Mid Plane
K	Connect N3_MSASHD1 on the Backplane to N3_OCUSAS1 on the Lower Mid Plane
L	Connect N3_MSASHD2 on the Backplane to N3_OCUSAS2 on the Lower Mid Plane
M	Connect N4_OCUPCIE1 on the Backplane to N4_OCUPCIE1 on the Upper Mid Plane
N	Connect N4_OCUPCIE2 on the Backplane to N4_OCUPCIE2 on the Upper Mid Plane
O	Connect N4_MSASHD1 on the Backplane to N4_OCUSAS1 on the Upper Mid Plane
P	Connect N4_MSASHD2 on the Backplane to N4_OCUSAS2 on the Upper Mid Plane

2.8 Removable/optional components

You may need to remove previously installed system components when installing or removing system devices. Or you may need to install the optional components into the system. This section tells how to remove/install the following components:

1. System fans
2. Power supply module



Ensure that the system is turned off before removing any components.

2.8.1 System fan

To replace a system fan:

1. Loosen the four (4) screws on the top and the side of the top cover, then push the top cover towards the rear of the system and remove the top cover.

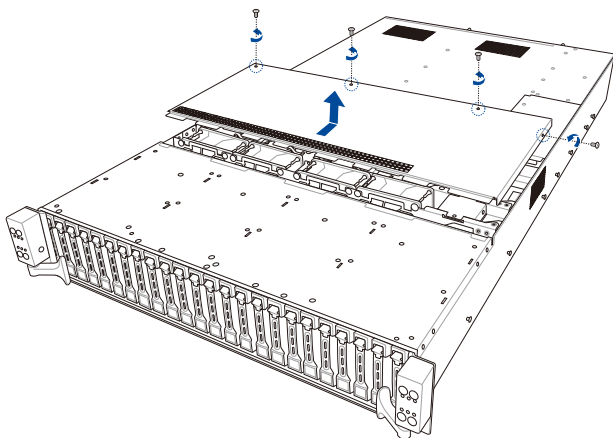

2. Prepare a replacement fan of the same type and size.
3. Disconnect the system fan cable from the fan connector on the Mid Plane.
4. Lift the fan then set it aside.

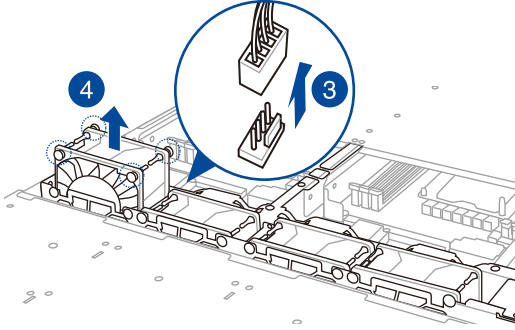

5. Repeat steps 3 to 4 to uninstall the other system fans.

2.8.2 Power supply module

To replace a power supply unit (PSU):

1. Lift up the PSU lever.
2. Hold the PSU lever, press the PSU latch (A) then carefully pull the PSU out of the system chassis (B).

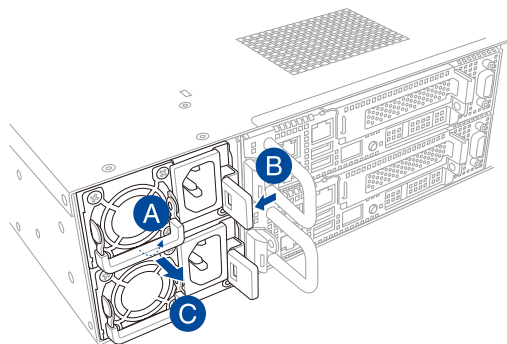

3. Prepare the replacement PSU.
4. Align and insert the replacement PSU into the empty PSU bay until it clicks in place.

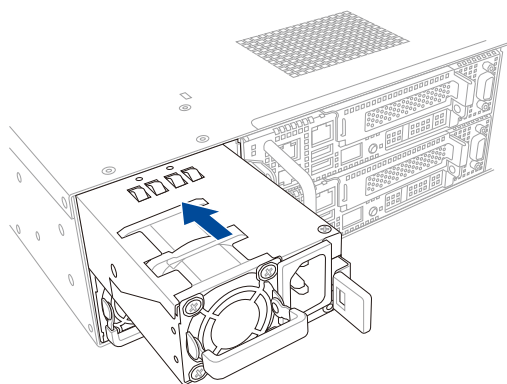



-
- The system automatically combines the two power supply modules as a single one. The combined output power varies with input voltages. Refer to the table below for details.

1600W

Input Voltage	Max. Output Power (Watt) per PSU
200V-240Vac, 9.5A, 47-63Hz	1600W

2200W

Input Voltage	Max. Output Power (Watt) per PSU
200V-240Vac, 12.6A, 47-63Hz	2200W

- To enable the hot-swap feature (redundant mode), keep the total power consumption of the system under the maximum output power of an individual power supply module.



-
- Always use PSUs with the same watt and power rating. Combining PSUs with different wattage (e.g. 1 x 1620 W + 1 x 2000 W) may yield unstable results and potential damage to your system.
 - For a steady power input, use only the power cables that come with the server system package.
-

Installation Options

3

This chapter describes how to install the optional components and devices into the barebone server.

3.1 Tool-less Friction Rail Kit

The tool less design of the rail kit allows you to easily install the rack rails into the server rack without the need for additional tools. The kit also comes with a metal stopping bracket that can be installed to provide additional support and stability to the server.

The tool-less rail kit package includes:

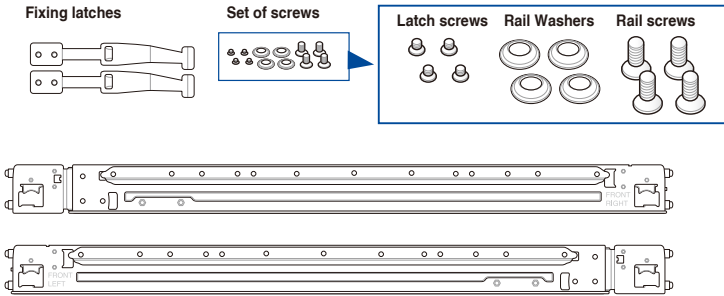

Installing the tool-less rack rail

To install the tool-less rack rails into the rack:

1. Secure the two fixing latches to the two sides of the server using the set of latch screws.



The locations of the screw holes vary with different server models. Refer to your server user manual for details.

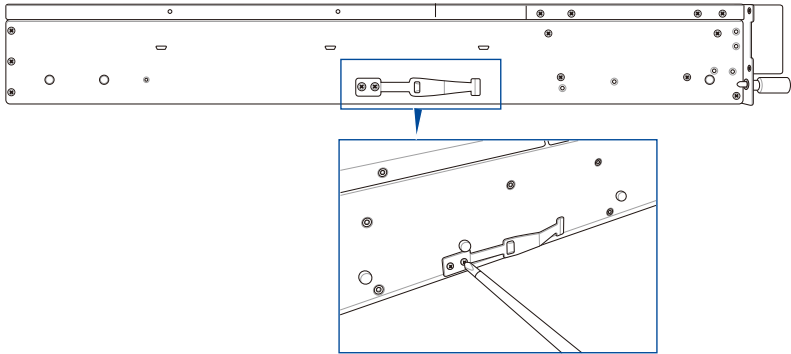

2. Select a desired space and place the appropriate rack rail (left and right) on opposite positions on the rack.



A 1U space consists of three square mounting holes with two thin lips on the top and the bottom.

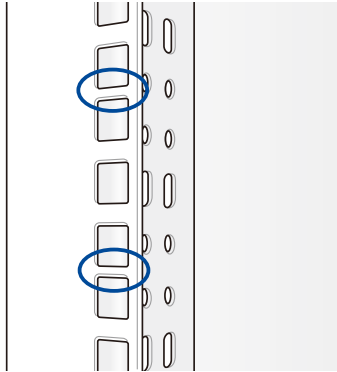

3. Press the spring lock then insert the studs into the selected square mounting holes on the rack post.
4. Press the spring lock on the other end of rail then insert the stud into the mounting hole on the rack post. Extend the rack rail, if necessary.
5. (Optional) Use the rail screw and rail washer that comes with the kit to secure the rack rail to the rack post.



A torque value of 14 kgf.cm is recommended for the rail screw.

6. Perform steps 3 to 5 for the other rack rail.



Ensure that the installed rack rails (left and right) are aligned, secured, and stable in place.

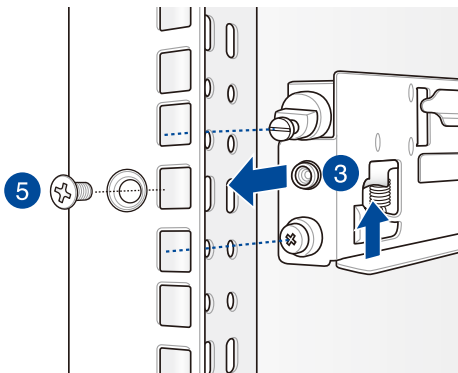

7. Lift the server chassis and insert into the rack rail.



- Ensure that the rack rail cabinet and the rack posts are stable and standing firmly on a level surface.
- We strongly recommend that at least two able-bodied persons perform the steps described in this guide.
- We recommend the use of an appropriate lifting tool or device, if necessary.

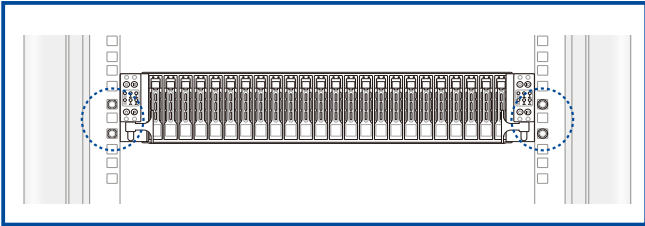

Ensure to include the side knots on the two sides of the server in the rack rail holders.



The illustrations shown above are for reference only.

3.2 Rail kit dimensions

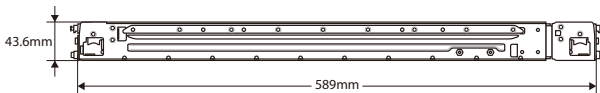
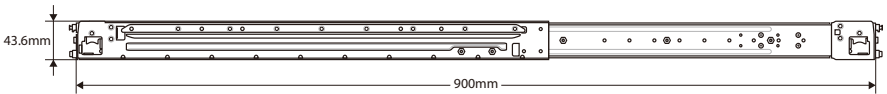

Motherboard Information

4

This chapter includes the motherboard layout and brief descriptions of the jumpers and internal connectors.

RS720Q-E9-RS24-S Mid Plane

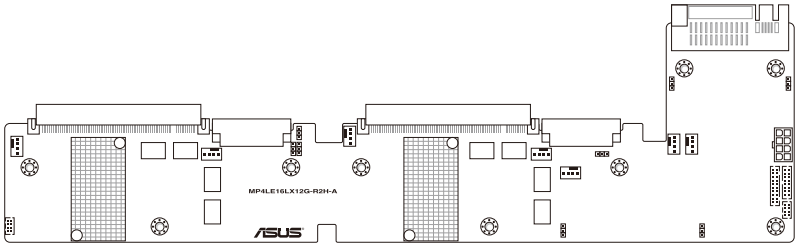

4.1.1 Layout contents

Jumpers		Page
1.	Clear RTC RAM (CLRRTC1)	4-5
2.	VGA controller setting (3-pin VGA_SW1)	4-6
3.	LAN controller setting (3-pin LAN_SW1, LAN_SW2)	4-6
4.	ME firmware force recovery setting (3-pin ME_RCVR1)	4-7
5.	DDR4 thermal event setting (3-pin DIMMTRIP1-2)	4-7
6.	BMC Setting (3-pin BMC_EN1)	4-8
7.	PMBus 1.2 PSU select jumper (3-pin SMART_PSU1)	4-8
8.	Chassis Intrusion (2-pin INTRUSION1)	4-9
9.	DMLAN setting (3-pin DM_IP_SEL1)	4-9
10.	PCH_MFG setting (3-pin PCH_MFG1)	4-10

Internal connectors		Page
1.	Trusted Platform Module connector (20-1 pin TPM1)	4-11
2.	Serial port connector (10-1 pin COM1)	4-11
3.	VROC_KEY connector (4-pin VROC_KEY1)	4-12
4.	VGA connector (16-1 pin VGA_HDR1)	4-12
5.	Mezzanine PCI card connectors (MEZZPCIE1; MEZZPCIE2)	4-13
6.	Power connector	4-13

Internal LEDs		Page
1.	BMC LED (BMCLED1)	4-14
2.	Standby Power LED (SBPWR1)	4-14
3.	Message LED (MESLED1)	4-15
4.	Location LED (LOCLED1)	4-15

Mid Plane jumper		Page
1.	12V_SEL1 jumper	4-16

4.2 Jumpers

1. Clear RTC RAM (CLRTC1)

This jumper allows you to clear the Real Time Clock (RTC) RAM in CMOS. You can clear the CMOS memory of date, time, and system setup parameters by erasing the CMOS RTC RAM data. The onboard button cell battery powers the RAM data in CMOS, which include system setup information such as system passwords.

To erase the RTC RAM:

1. Turn OFF the computer and unplug the power cord.
2. Move the jumper cap from pins 1–2 (default) to pins 2–3. Keep the cap on pins 2–3 for about 5–10 seconds, then move the cap back to pins 1–2.
3. Plug the power cord and turn ON the computer.
4. Hold down the key during the boot process and enter BIOS setup to re-enter data.



Except when clearing the RTC RAM, never remove the cap on CLRTC jumper default position. Removing the cap will cause system boot failure!



If the steps above do not help, remove the onboard battery and move the jumper again to clear the CMOS RTC RAM data. After the CMOS clearance, reinstall the battery.

Z11PH-D12 Clear RTC RAM

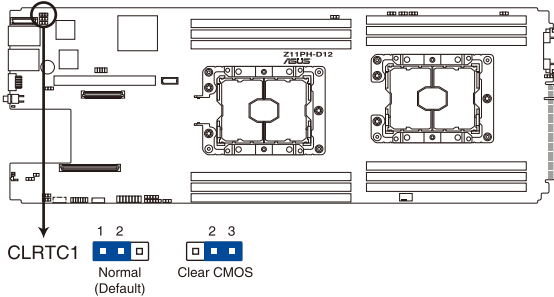

2. VGA controller setting (3-pin VGA_SW1)

This jumper allows you to enable or disable the onboard VGA controller. Set to pins 1–2 to activate the VGA feature.

Z11PH-D12 VGA setting

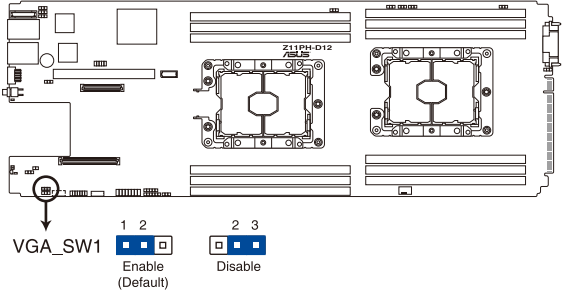

3. LAN controller setting (3-pin LAN_SW1, LAN_SW2)

These jumpers allow you to enable or disable the onboard Intel® I210AT Gigabit LAN controllers. Set to pins 1–2 to activate the Gigabit LAN feature.

Z11PH-D12 LAN setting

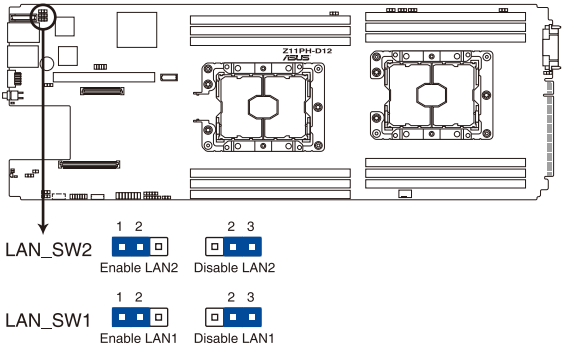

4. ME firmware force recovery setting (3-pin ME_RCVR1)

This jumper allows you to quickly recover the Intel Management Engine (ME) firmware when it becomes corrupted.

Z11PH-D12 ME recovery setting

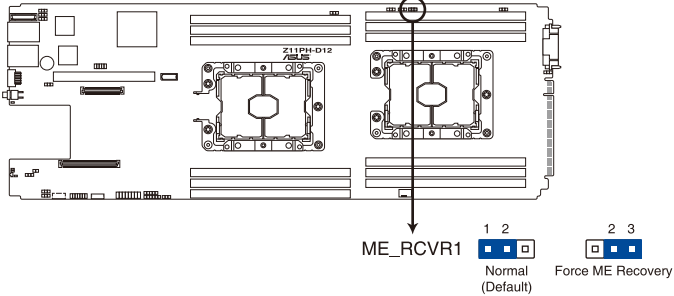

5. DDR4 thermal event setting (3-pin DIMMTRIP1-2)

These jumpers allow you to enable or disable DDR4 DIMM thermal sensing event pin.

Z11PH-D12 Thermaltrip setting

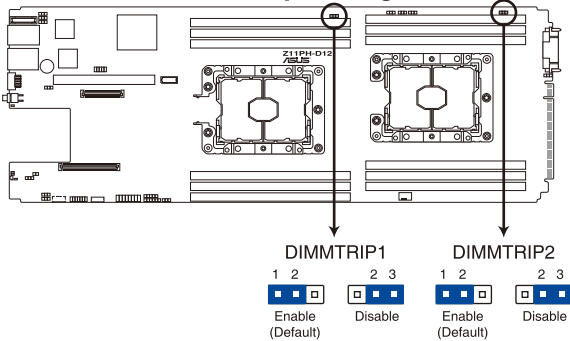

6. BMC Setting (3-pin BMC_EN1)

This jumper allows you to enable or disable the ASMB9.

Z11PH-D12 BMC setting

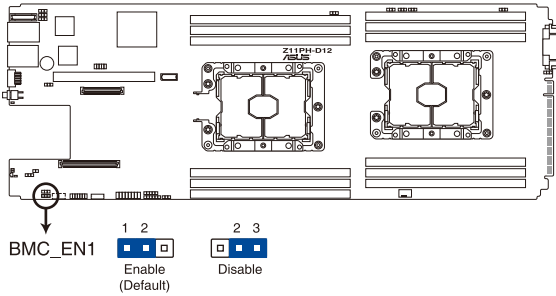

7. PMBus 1.2 PSU select jumper (3-pin SMART_PSU1)

This jumper allows you to select PSU PMBus version.

Z11PH-D12 PMBus 1.2 PSU setting

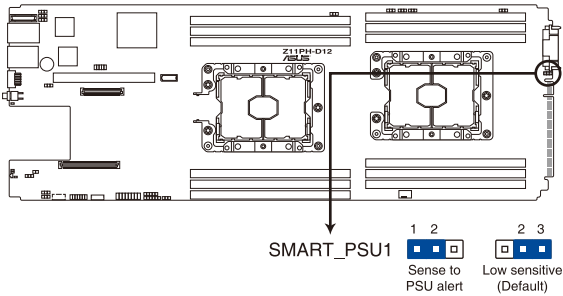

8. Chassis Intrusion (2-pin INTRUSION1)

These leads are for the intrusion detection feature for chassis with intrusion sensor or microswitch. When you remove any chassis component, the sensor triggers and sends a high level signal to these leads to record a chassis intrusion event. The default setting is short CHASSIS# and GND pin by jumper cap to disable the function.

Z11PH-D12 Chassis Intrusion connector

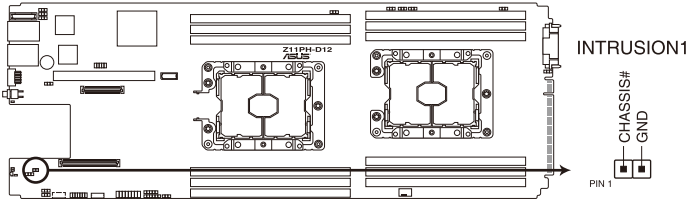

9. DMLAN setting (3-pin DM_IP_SEL1)

This jumper allows you to select the DMLAN setting. Set to pins 2-3 to force the DMLAN IP to static mode (IP=10.10.10.10, submask=255.255.255.0).

Z11PH-D12 DM_IP_SEL1 setting

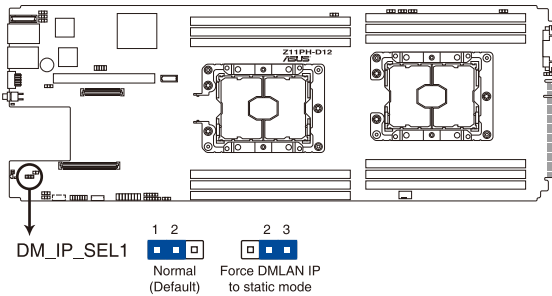

10. PCH_MFG setting (3-pin PCH_MFG1)

This jumper allows you to update the BIOS ME block.

Z11PH-D12 PCH_MFG setting

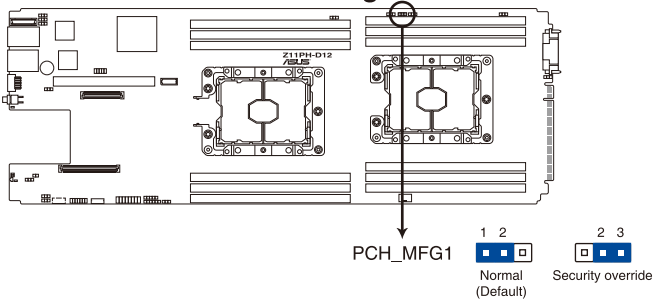

4.3 Internal connectors

1. Trusted Platform Module connector (20-pin TPM)

This connector supports a Trusted Platform Module (TPM) system, which can securely store keys, digital certificates, passwords, and data. A TPM system also helps enhance network security, protects digital identities, and ensures platform integrity.

Z11PH-D12 TPM connector

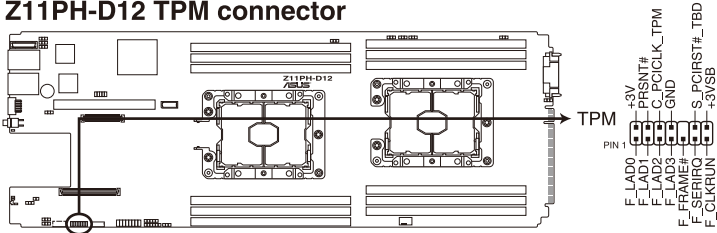

2. Serial port connector (10-pin COM1)

This connector is for a serial (COM) port. Connect the serial port module cable to this connector, then install the module to a slot opening at the back of the system chassis.

Z11PH-D12 Serial port connector

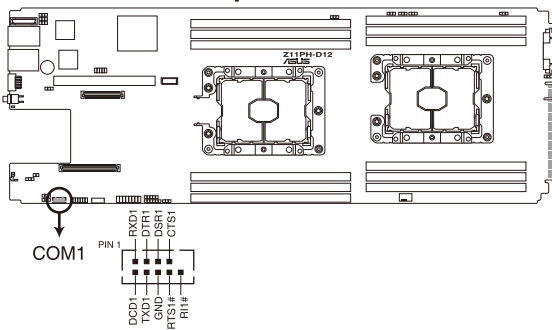

3. VROC_KEY connector (4-pin VROC_KEY1)

This connector allows you to connect a KEY module to enable CPU RAID functions with Intel® CPU RSTe.

Z11PH-D12 VROC_KEY1

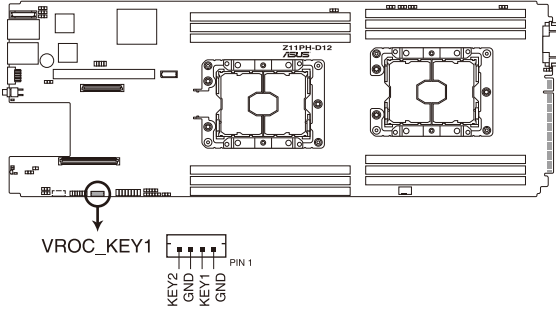

The KEY module is purchased separately.

4. VGA connector (16-1 pin VGA_HDR1)

This connector supports the VGA High Dynamic-Range interface.

Z11PH-D12 Internal VGA connector

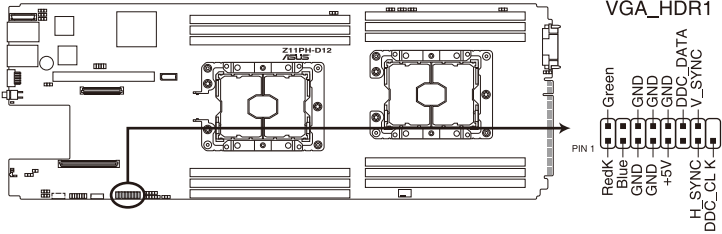

5. **Mezzanine PCI card connectors (MEZZPCIE1; MEZZPCIE2)**

The MEZZPCIE1, MEZZPCIE2, and MEZZKR1 connectors support Open Compute Project (OCP) cards.

Z11PH-D12 MEZZPCIE connectors

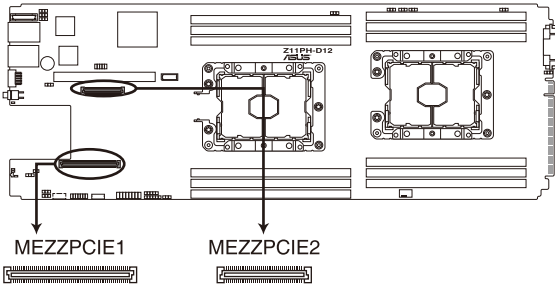

6. **Power connector**

This power connector connects to the Mid Plane.

Z11PH-D12 PWR connector

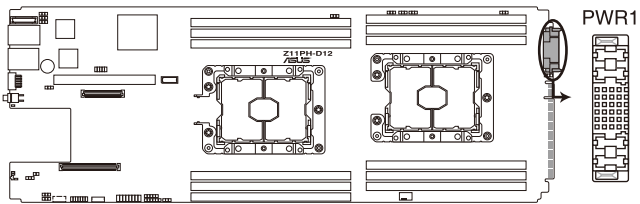

4.4 Internal LEDs

1. BMC LED (BMCLED1)

The green heartbeat LED blinks per second to indicate that the ASMB9 is working normally.

Z11PH-D12 BMC LED

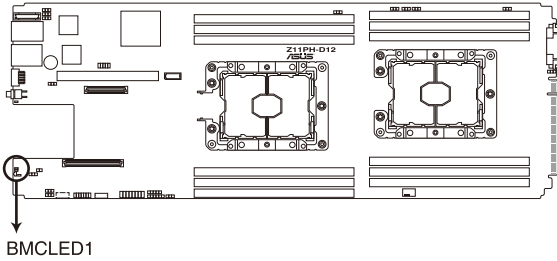

- The heartbeat LED functions only when you enable the ASUS ASMB9.
- Every time after the AC power is replugged, you have to wait for about 30 seconds for the system to power up.

2. Standby Power LED (SBPWR1)

The motherboard comes with a standby power LED. The green LED lights up to indicate that the system is ON, in sleep mode, or in soft-off mode. This is a reminder that you should shut down the system and unplug the power cable before removing or plugging in any motherboard component. The illustration below shows the location of the onboard LED.

Z11PH-D12 Standby Power LED

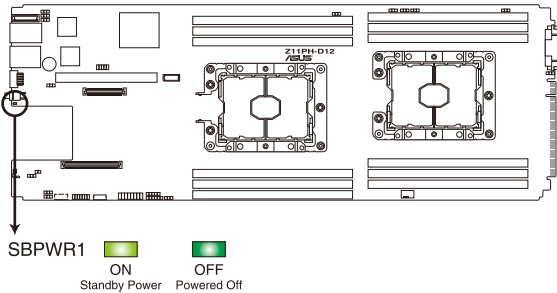

3. Message LED (MESLED1)

This onboard LED lights up to red when there is temperature warning or a BMC event log is generated.

Z11PH-D12 MESLED1

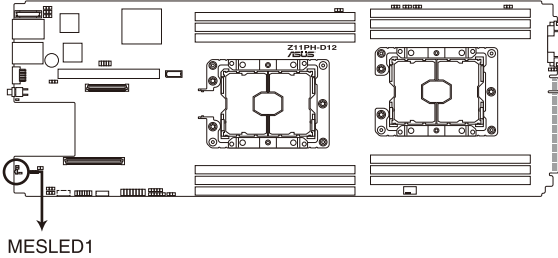

4. Location LED (LOCLED1)

This onboard LED lights up when the Location button on the server is pressed or when triggered by a system management software. The Location LED helps visually locate and quickly identify the server in error on a server rack.

Z11PH-D12 Location LED

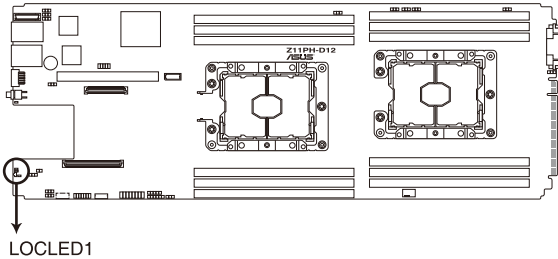

4.5 Mid Plane jumper



The illustration in this section may differ between models, but the location of the jumper remains the same.

1. 12V_SEL1 jumper

This jumper allows you to enhance the 12V standby when the system's +12VSB is not enough.

Mid plane 12V_SEL1 setting

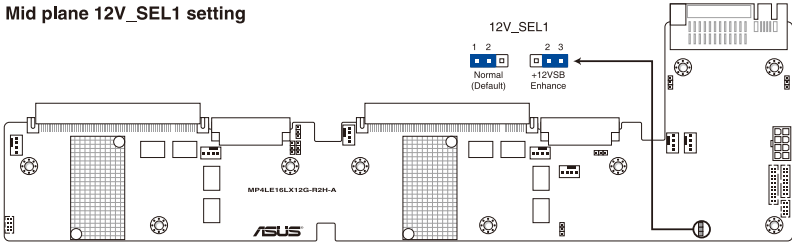

BIOS Setup

5

This chapter tells how to change the system settings through the BIOS Setup menus. Detailed descriptions of the BIOS parameters are also provided.

5.1 Managing and updating your BIOS

The following utilities allow you to manage and update the motherboard Basic Input/Output System (BIOS) setup:

1. **ASUS CrashFree BIOS 3**

To recover the BIOS using a bootable USB flash disk drive when the BIOS file fails or gets corrupted.

2. **ASUS EzFlash**

Updates the BIOS using a USB flash disk.

3. **BUPDATER**

Updates the BIOS in DOS mode using a bootable USB flash disk drive.

Refer to the corresponding sections for details on these utilities.



Save a copy of the original motherboard BIOS file to a bootable USB flash disk drive in case you need to restore the BIOS in the future. Copy the original motherboard BIOS using the BUPDATER utility.

5.1.1 **ASUS CrashFree BIOS 3 utility**

The ASUS CrashFree BIOS 3 is an auto recovery tool that allows you to restore the BIOS file when it fails or gets corrupted during the updating process. You can update a corrupted BIOS file using a USB flash drive that contains the updated BIOS file.



Prepare a USB flash drive containing the updated motherboard BIOS before using this utility.

Recovering the BIOS from a USB flash drive

To recover the BIOS from a USB flash drive:

1. Insert the USB flash drive with the original or updated BIOS file to one USB port on the system.
2. The utility will automatically recover the BIOS. It resets the system when the BIOS recovery finished.



DO NOT shut down or reset the system while recovering the BIOS! Doing so would cause system boot failure!



The recovered BIOS may not be the latest BIOS version for this motherboard. Visit the ASUS website at www.asus.com to download the latest BIOS file.

5.1.2 ASUS EZ Flash Utility

The ASUS EZ Flash Utility feature allows you to update the BIOS without having to use a DOS-based utility.



Before you start using this utility, download the latest BIOS from the ASUS website at www.asus.com.

To update the BIOS using EZ Flash Utility:

1. Insert the USB flash disk that contains the latest BIOS file into the USB port.
2. Enter the BIOS setup program. Go to the **Tool** menu then select **ASUS EZ Flash Utility**. Press <Enter>.

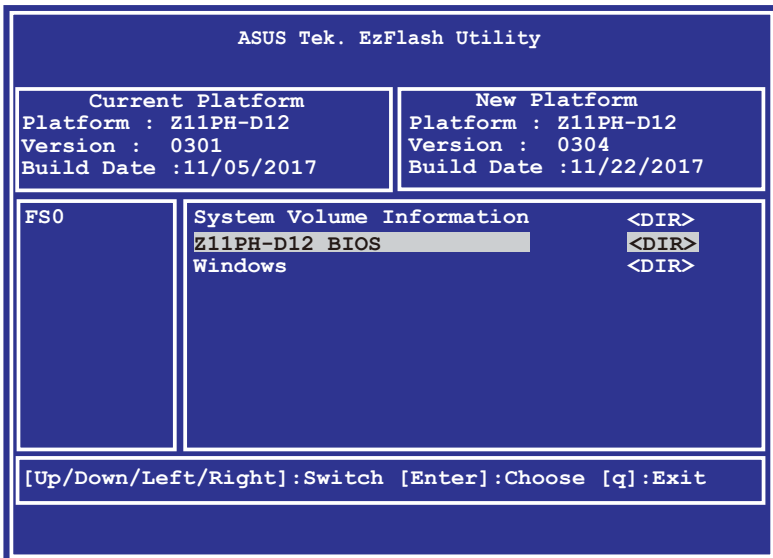

3. Press <Tab> to switch to the **Drive** field.
4. Press the Up/Down arrow keys to find the USB flash disk that contains the latest BIOS, then press <Enter>.
5. Press <Tab> to switch to the **Folder Info** field.
6. Press the Up/Down arrow keys to find the BIOS file, and then press <Enter> to perform the BIOS update process. Reboot the system when the update process is done.



-
- This function can support devices such as a USB flash disk with FAT 32/16 format and single partition only.
 - DO NOT shut down or reset the system while updating the BIOS to prevent system boot failure!
-



Ensure to load the BIOS default settings to ensure system compatibility and stability. Press <F5> and select **Yes** to load the BIOS default settings.

5.1.3 BUPDATER utility



The succeeding BIOS screens are for reference only. The actual BIOS screen displays may not be the same as shown.

The BUPDATER utility allows you to update the BIOS file in the DOS environment using a bootable USB flash disk drive with the updated BIOS file.

Updating the BIOS file

To update the BIOS file using the BUPDATER utility:

1. Visit the ASUS website at www.asus.com and download the latest BIOS file for the motherboard. Save the BIOS file to a bootable USB flash disk drive.
2. Copy the BUPDATER utility (BUPDATER.exe) from the ASUS support website at support.asus.com to the bootable USB flash disk drive you created earlier.
3. Boot the system in DOS mode, then at the prompt, type:

```
BUPDATER /i [filename] .CAP
```

where [filename] is the latest or the original BIOS file on the bootable USB flash disk drive, then press <Enter>.

```
A:\>BUPDATER /i[file name].CAP
```

- The utility verifies the file, then starts updating the BIOS file.

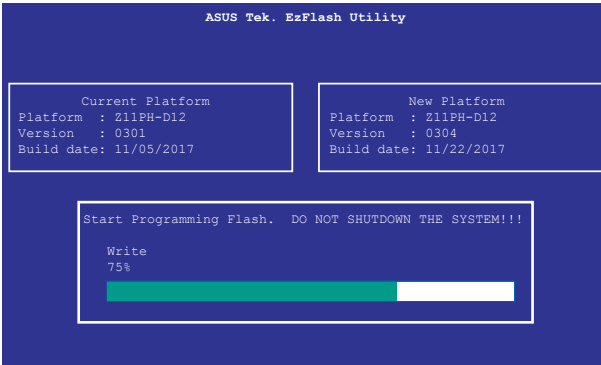

DO NOT shut down or reset the system while updating the BIOS to prevent system boot failure!

- The utility returns to the DOS prompt after the BIOS update process is completed. Reboot the system from the hard disk drive.

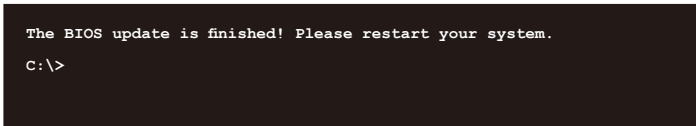

5.2 BIOS setup program

This motherboard supports a programmable firmware chip that you can update using the provided utility described in section 5.1 **Managing and updating your BIOS**.

Use the BIOS Setup program when you are installing a motherboard, reconfiguring your system, or prompted to “Run Setup.” This section explains how to configure your system using this utility.

Even if you are not prompted to use the Setup program, you can change the configuration of your computer in the future. For example, you can enable the security password feature or change the power management settings. This requires you to reconfigure your system using the BIOS Setup program so that the computer can recognize these changes and record them in the CMOS RAM of the firmware chip.

The firmware chip on the motherboard stores the Setup utility. When you start up the computer, the system provides you with the opportunity to run this program. Press during the Power-On Self-Test (POST) to enter the Setup utility; otherwise, POST continues with its test routines.

If you wish to enter Setup after POST, restart the system by pressing <Ctrl>+<Alt>+<Delete>, or by pressing the reset button on the system chassis. You can also restart by turning the system off and then back on. Do this last option only if the first two failed.

The Setup program is designed to make it as easy to use as possible. Being a menu-driven program, it lets you scroll through the various sub-menus and make your selections from the available options using the navigation keys.



- The default BIOS settings for this motherboard apply for most conditions to ensure optimum performance. If the system becomes unstable after changing any BIOS settings, load the default settings to ensure system compatibility and stability. Press <F5> and select **Yes** to load the BIOS default settings.
- The BIOS setup screens shown in this section are for reference purposes only, and may not exactly match what you see on your screen.
- Visit the ASUS website (www.asus.com) to download the latest BIOS file for this motherboard.

The system then runs the power-on self-test or POST. While the tests are running, the BIOS beeps or additional messages appear on the screen. If you do not see anything within 30 seconds from the time you turned on the power, the system may have failed a power-on test. Check the jumper settings and connections or call your retailer for assistance. The following shows the possible beep codes and its corresponding error condition.

BIOS Beep codes	
Beep	Error condition
1 short	Power supply surges detected during the previous power on.
1 short	No Keyboard Detected.
1 short, 2 short	No DIMM Detected.
1 short, 8 short	No VGA Detected.
2 long	Chassis Intrusion.
2 long	BIOS-image Crash Detected.

5.2.1 BIOS menu screen

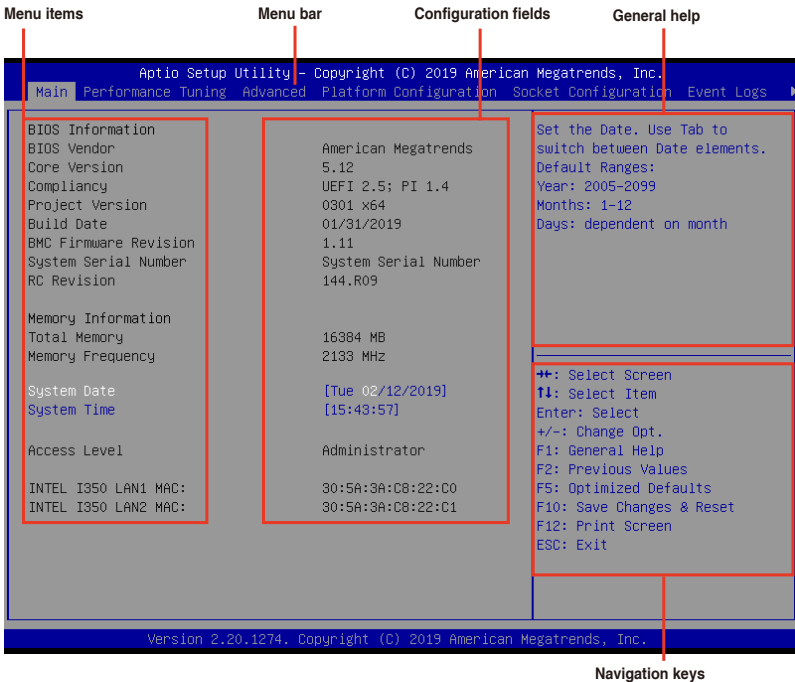

5.2.2 Menu bar

The menu bar on top of the screen has the following main items:

Main	For changing the basic system configuration
Performance Tuning	For changing the performance settings
Advanced	For changing the advanced system settings
Platform Configuration	For changing the platform settings
Socket Configuration	For changing the socket settings
Event Logs	For changing the event log settings
Server Mgmt	For changing the Server Mgmt settings
Security	For changing the security settings
Boot	For changing the system boot configuration
Tool	For configuring options for special functions
Save & Exit	For selecting the exit options

To select an item on the menu bar, press the right or left arrow key on the keyboard until the desired item is highlighted.

5.2.3 Menu items

The highlighted item on the menu bar displays the specific items for that menu. For example, selecting Main shows the Main menu items.

The other items (Advanced, Platform Configuration, Socket Configuration, Event Logs, Server Mgmt, Security, Boot, Tool, and Save & Exit) on the menu bar have their respective menu items.

5.2.4 Submenu items

A solid triangle before each item on any menu screen means that the item has a submenu. To display the submenu, select the item then press <Enter>.

5.2.5 Navigation keys

At the bottom right corner of a menu screen are the navigation keys for the BIOS setup program. Use the navigation keys to select items in the menu and change the settings.

5.2.6 General help

At the top right corner of the menu screen is a brief description of the selected item.

5.2.7 Configuration fields

These fields show the values for the menu items. If an item is user-configurable, you can change the value of the field opposite the item. You cannot select an item that is not user-configurable.

A configurable field is enclosed in brackets, and is highlighted when selected. To change the value of a field, select it and press <Enter> to display a list of options.

5.2.8 Pop-up window

Select a menu item and press <Enter> to display a pop-up window with the configuration options for that item.

5.2.9 Scroll bar

A scroll bar appears on the right side of a menu screen when there are items that do not fit on the screen. Press the Up/Down arrow keys or <Page Up> /<Page Down> keys to display the other items on the screen.

5.3 Main menu

When you enter the BIOS Setup program, the Main menu screen appears. The Main menu provides you an overview of the basic system information, and allows you to set the system date, time, language, and security settings.

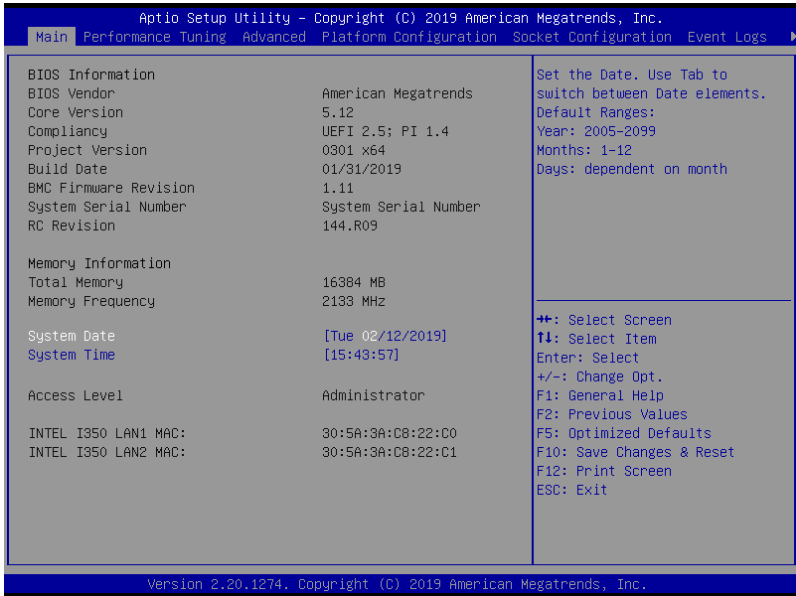

5.3.1 System Date [Day xx/xx/xxxx]

Allows you to set the system date.

5.3.2 System Time [xx:xx:xx]

Allows you to set the system time.

5.4 Performance Tuning menu

The Performance Tuning menu items allow you to change performance related settings for different scenarios.

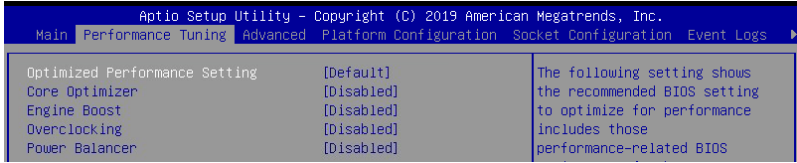

Optimized Performance Setting [Default]

Allows you to select performance settings for different scenarios.

- [Default] Default settings.
- [By Benchmark] Optimize for different kinds of benchmarks. Select this option, then select a benchmark type from the >> list.
- [By Workload] Optimize for different kinds of workloads. Select this option, then select a workload type from the >> list.

Configuration options:

[Peak Frequency Optimized] - Applies settings with performance and power consumption balance. Recommended for users that need higher performance.

[Latency Optimized] - Applies settings with low latency results. Recommended for latency-sensitive users.

[Power Efficient Optimized] - Applies settings with power efficiency. Recommended for general users.

[HPC] - Applies settings with optimized compute capability. Recommend for traditional HPC applications.



Core Optimizer and Engine Boost appear only when you set **Optimized Performance Setting** to **[Default]** or **[By Benchmark]**.

Core Optimizer [Disabled]

Enable this item to keep the processor operating at the turbo frequency.
Configuration options: [Disabled] [Enabled]



Linux support may vary by version of the OS.

Engine Boost [Disabled]

Enable this item to boost the CPU's frequency.
Configuration options: [Disabled] [Level1] [Level2] [Level3(Max)]

Overclocking [Disabled]

Enable this item to increase the CPU's clock.
Configuration options: [Disabled] [Level1] [Level2] [Level3(Max)]



Operate with an ambient temperature of 25°C or lower for optimized performance.



Please note that overclocking might cause component damage or system crashes, which may reduce the lifespan of the system and the CPU. Use this tool at your own risk.

Power Balancer [Disabled]

Select [Enable Auto] to dynamically adjust the frequency of all CPU cores based on the current utilization, delivering better performance per watt for improved system energy efficiency.
Configuration options: [Disabled] [Enable Auto] [Enable Manual]

5.5 Advanced menu

The Advanced menu items allow you to change the settings for the CPU and other system devices.



Take caution when changing the settings of the Advanced menu items. Incorrect field values can cause the system to malfunction.

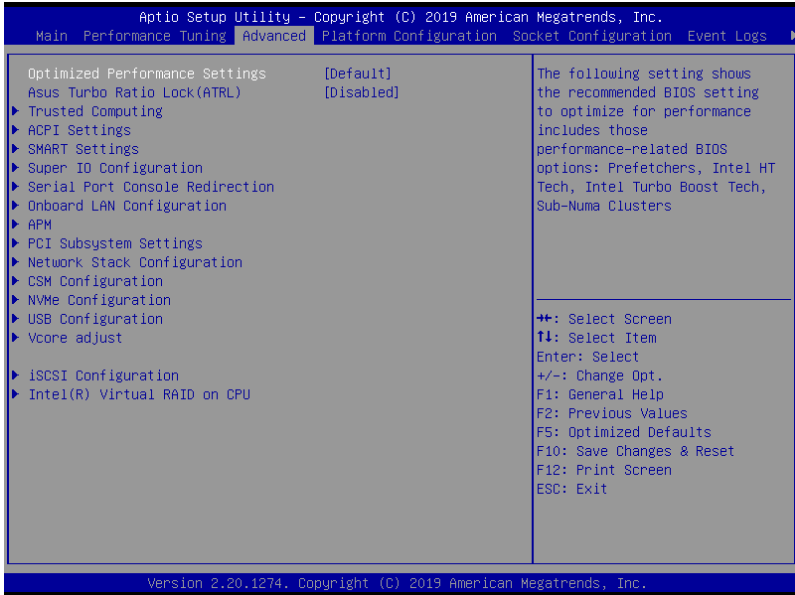

Optimized Performance Settings [Default]

This option allows you to select a recommended BIOS setting to optimize performance.

Asus Turbo Ratio Lock (ATRL) [Disabled]

Allows you to keep the processor operating at the turbo highest frequency for maximum performance.

Configuration options: [Disabled] [Enabled]

5.5.1 Trusted Computing

Aptio Setup Utility - Copyright (C) 2019 American Megatrends, Inc.		
Advanced		
Configuration		
Security Device Support	[Enabled]	Enables or Disables BIOS support for security device. O.S. will not show Security Device. TCG EFI protocol and
NO Security Device Found		

Configuration

Security Device Support [Enabled]

Allows you to enable or disable the BIOS support for security device.

Configuration options: [Disabled] [Enabled]

5.5.2 ACPI Settings

Aptio Setup Utility - Copyright (C) 2019 American Megatrends, Inc.		
Advanced		
ACPI Settings		Enables or Disables BIOS ACPI Auto Configuration.
Enable ACPI Auto Configuration	[Disabled]	
Enable Hibernation	[Enabled]	

Enable ACPI Auto Configuration [Disabled]

Allows you to enable or disable the BIOS ACPI Auto Configuration.

Configuration options: [Disabled] [Enabled]

Enable Hibernation [Enabled]

Allows you to enable or disable the ability of the system to hibernate (OS/Sleep State).

Configuration options: [Disabled] [Enabled]



This option may be not effective with some OS.

5.5.3 Smart Settings

Aptio Setup Utility - Copyright (C) 2019 American Megatrends, Inc.		
Advanced		
SMART Settings		Run SMART Self Test on all HDDs during POST.
SMART Self Test	[Enabled]	

SMART Self Test [Enabled]

Allows you to run SMART Self Test on all HDDs during POST.

Configuration options: [Disabled] [Enabled]

5.5.4 Super IO Configuration

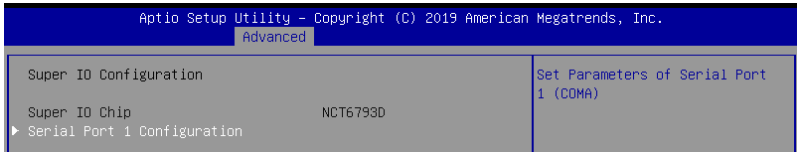

Serial Port 1 Configuration

Allows you to set the parameters of Serial Port 1.

Serial Port [Enabled]

Allows you to enable or disable Serial Port.

Configuration options: [Disabled] [Enabled]



The following item appears only when you set **Serial Port** to **[Enabled]**.

Change Settings [Auto]

Allows you to choose the setting for Super IO device.

Configuration options: [Auto] [IO=3F8h; IRQ=4;] [IO=3F8h; IRQ=3, 4, 5, 6, 7, 9, 10, 11, 12;] [IO=2F8h; IRQ=3, 4, 5, 6, 7, 9, 10, 11, 12;] [IO=3E8h; IRQ=3, 4, 5, 6, 7, 9, 10, 11, 12;] [IO=2E8h; IRQ=3, 4, 5, 6, 7, 9, 10, 11, 12;]

5.5.5 Serial Port Console Redirection

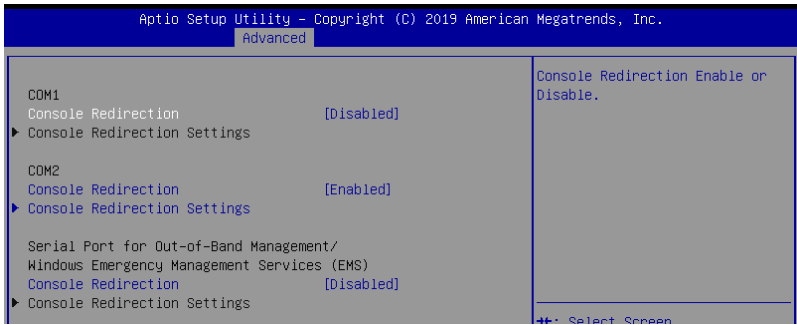

COM1/COM2

Console Redirection [Disabled]

Allows you to enable or disable the console redirection feature.

Configuration options: [Disabled] [Enabled]



The following item appears only when you set **Console Redirection** to **[Enabled]**.

Console Redirection Settings

This item becomes configurable only when you enable the Console Redirection item. The settings specify how the host computer and the remote computer (which the user is using) will exchange data. Both computers should have the same or compatible settings.

Aptio Setup Utility – Copyright (C) 2019 American Megatrends, Inc.		
Advanced		
COM1 Console Redirection Settings		Emulation: ANSI: Extended ASCII char set. VT100: ASCII char set. VT100+: Extends VT100 to support color, function keys, etc. VT-UTF8: Uses UTF8 encoding to map Unicode chars onto 1 or more bytes.
Terminal Type	[VT-UTF8]	
Bits per second	[57600]	
Data Bits	[8]	
Parity	[None]	
Stop Bits	[1]	
Flow Control	[Hardware RTS/CTS]	
VT-UTF8 Combo Key Support	[Enabled]	
Recorder Mode	[Disabled]	
Legacy OS Redirection Resolution	[80x24]	
Putty KeyPad	[VT100]	
Redirection After BIOS POST	[Always Enable]	
		←*: Select Screen ↑↓: Select Item

Terminal Type [VT-UTF8]

Allows you to set the terminal type.

- [VT100] ASCII char set.
- [VT100+] Extends VT100 to support color, function keys, et.
- [VT-UTF8] Uses UTF8 encoding to map Unicode chars onto 1 or more bytes
- [ANSI] Extended ASCII char set

Bits per second [57600]

Selects serial port transmission speed. The speed must be matched on the other side. Long or noisy lines may require lower speeds.

Configuration options: [9600] [19200] [38400] [57600] [115200]

Data Bits [8]

Configuration options: [7] [8]

Parity [None]

A parity bit can be sent with the data bits to detect some transmission errors. [Mark] and [Space] parity do not allow for error detection.

- [None] None
- [Even] parity bit is 0 if the num of 1's in the data bits is even
- [Odd] parity bit is 0 if num of 1's in the data bits is odd
- [Mark] parity bit is always 1
- [Space] parity bit is always 0

Stop Bits [1]

Stop bits indicate the end of a serial data packet. (A start bit indicates the beginning.) The standard setting is 1 stop bit. Communication with slow devices may require more than 1 stop bit.

Configuration options: [1] [2]

Flow Control [Hardware RTS/CTS]

Flow control can prevent data loss from buffer overflow. When sending data, if the receiving buffers are full, a “stop” signal can be sent to stop the data flow. Once the buffers are empty, a “start” signal can be sent to re-start the flow. Hardware flow control uses two wires to send start/stop signals.

Configuration options: [None] [Hardware RTS/CTS]

VT -UTF8 Combo Key Support [Enabled]

This allows you to enable the VT -UTF8 Combination Key Support for ANSI/VT100 terminals.

Configuration options: [Disabled] [Enabled]

Recorder Mode [Disabled]

With this mode enabled only text will be sent. This is to capture Terminal data.

Configuration options: [Disabled] [Enabled]

Legacy OS Redirection Resolution [80x24]

This allows you to set the number of rows and columns supported on the Legacy OS.

Configuration options: [80x24] [80x25]

Putty Keypad [VT100]

This allows you to select the FunctionKey and Keypad on Putty.

Configuration options: [VT100] [LINUX] [XTERMR6] [SCO] [ESCN] [VT400]

Redirection After BIOS POST [Always Enable]

This setting allows you to specify if Bootloader is selected than Legacy console redirection.

Configuration options: [Always Enable] [Bootloader]

Legacy Console Redirection

Legacy Console Redirection Settings

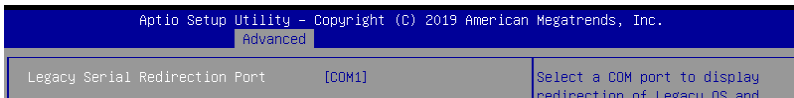

Legacy Serial Redirection Port [COM1]

Allows you to select a COM port to display redirection of Legacy OS and Legacy OPROM Messages.

Configuration options: [COM1] [COM2]

Serial Port for Out-of-Band Management/

Windows Emergency Management Services (EMS)

Console Redirection [Disabled]

Allows you to enable or disable the console redirection feature.

Configuration options: [Disabled] [Enabled]



The following item appears only when you set **Console Redirection** to **[Enabled]**.

Console Redirection Settings

Out-of-Band Mgmt Port [COM1]

Microsoft Windows Emergency Management Services (EMS) allow for remote management of a Windows Server OS through a serial port.

Configuration options: [COM1] [COM2]

Terminal Type [VT-UTF8]

Microsoft Windows Emergency Management Services (EMS) allow for remote management of a Windows Server OS through a serial port.

Configuration options: [VT100] [VT100+] [VT-UTF8] [ANSI]

Bits per second [115200]

Microsoft Windows Emergency Management Services (EMS) allow for remote management of a Windows Server OS through a serial port.

Configuration options: [9600] [19200] [57600] [115200]

Flow Control [None]

Microsoft Windows Emergency Management Services (EMS) allow for remote management of a Windows Server OS through a serial port.

Configuration options: [None] [Hardware RTS/CTS] [Software Xon/Xoff]

5.5.6 Onboard LAN Configuration

Aptio Setup Utility - Copyright (C) 2019 American Megatrends, Inc.	
Advanced	
▶ Onboard I350 LAN Configuration	Onboard I350 LAN Enable/Disable

Onboard I350 LAN Configuration

Aptio Setup Utility - Copyright (C) 2019 American Megatrends, Inc.	
Advanced	
Onboard I350 LAN Configuration	Intel LAN Enable/Disable
INTEL I350 LAN1 MAC:	30:5A:3A:C8:22:C0
INTEL I350 LAN2 MAC:	30:5A:3A:C8:22:C1
Intel LAN1 Enable	[Enabled]
Intel LAN1 ROM Type	[PXE]
Intel LAN2 Enable	[Enabled]
Intel LAN2 ROM Type	[Disabled]

Intel LAN1 Enable [Enabled]

Allows you to enable or disable the Intel LAN.

Configuration options: [Disabled] [Enabled]



The following item appears only when you set **Intel LAN1 Enable** to **[Enabled]**.

Intel LAN ROM Type [PXE]

Allows you to select the Intel LAN ROM type.

Configuration options: [Disabled] [PXE] [iSCSI]



Due to Intel® limitations, both Intel LAN ROM Type options should be the same when **[PXE]** or **[iSCSI]** is selected.

Intel LAN2 Enable [Enabled]

Allows you to enable or disable the Intel LAN.

Configuration options: [Disabled] [Enabled]



The following item appears only when you set **Intel LAN2 Enable** to **[Enabled]**.

Intel LAN2 ROM Type [Disabled]

Allows you to select the Intel LAN ROM type.

Configuration options: [Disabled] [PXE] [iSCSI]



Due to Intel® limitations, both Intel LAN ROM Type options should be the same when **[PXE]** or **[iSCSI]** is selected.

5.5.7 APM

Allows you to configure the Advance Power Management (APM) settings.

Aptio Setup Utility - Copyright (C) 2019 American Megatrends, Inc.		
Advanced		
Restore On AC Power Loss	[Last State]	Specify what state to go to when power is re-applied after a power failure (G3 state).
Power On By PCIE	[Disabled]	
Power On By RTC	[Disabled]	

Restore AC Power Loss [Last State]

When set to [Power Off], the system goes into off state after an AC power loss. When set to [Power On], the system will reboot after an AC power loss. When set to [Last State], the system goes into either off or on state, whatever the system state was before the AC power loss.

Configuration options: [Power Off] [Power On] [Last State]

Power On By PCIE [Disabled]

[Disabled] Disables the PCIE devices to generate a wake event.

[Enabled] Enables the PCIE devices to generate a wake event.

Power On By RTC [Disabled]

[Disabled] Disables RTC to generate a wake event.

[Enabled] When set to [Enabled], the items RTC Alarm Date (Days) and Hour/Minute/Second will become user-configurable with set values.

5.5.8 PCI Subsystem Settings

Allows you to configure PCI, PCI-X, and PCI Express Settings.

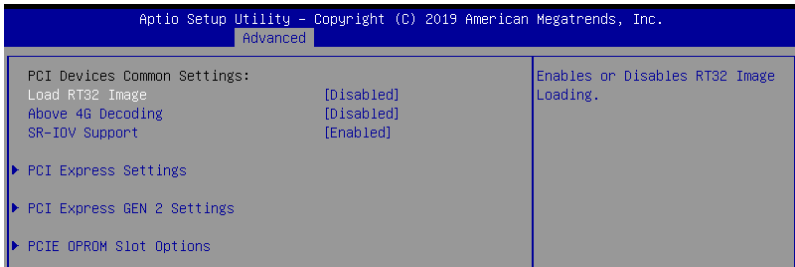

Load RT32 Image [Disabled]

Allows you to enable or disable RT32 Image Loading.

Configuration options: [Disabled] [Enabled]

Above 4G Decoding [Disabled]

Allows you to enable or disable 64-bit capable devices to be decoded in above 4G address space. It only works if the system supports 64-bit PCI decoding.

Configuration options: [Disabled] [Enabled]



The following item appears only when you set **Above 4G Decoding** to [Enabled].

First VGA 4G Decode [Auto]

This option enables or disables 64-bit capable devices to be decoded in above 4G address space (only if system supports 64-bit PCI decoding).

[Auto] Auto
[Above_4G] Force First VGA to above 4G

SR-IOV Support [Enabled]

This option enables or disables Single Root IO Virtualization Support if the system has SRIOV capable PCIe devices.

Configuration options: [Disabled] [Enabled]

PCI Express Settings

PCI Express Device Register Settings

Relaxed Ordering [Enabled]

This option allows you to enable or disable PCI Express Device Relaxed Ordering.

Configuration options: [Disabled] [Enabled]

Extended Tag [Disabled]

This option allows Device to use an 8-bit Tag field as a requester when set to Enabled.

Configuration options: [Disabled] [Enabled]

No Snoop [Enabled]

This option allows you to enable or disable PCI Express Device No Snoop option.
Configuration options: [Disabled] [Enabled]

Maximum Payload [Auto]

This option allows you to set the Maximum Payload of PCI Express Device or allow System BIOS to select the value.

Configuration options: [Auto] [128 Bytes] [256 Bytes] [512 Bytes] [1024 Bytes] [2048 Bytes] [4096 Bytes]

Maximum Read Request [Auto]

This option allows you to set the Maximum Read Request of PCI Express Device or allow System BIOS to select the value.

Configuration options: [Auto] [128 Bytes] [256 Bytes] [512 Bytes] [1024 Bytes] [2048 Bytes] [4096 Bytes]

PCI Express Link Register Settings

ASPM Support [Disabled]

This option allows you to set the ASPM level.

[Force L0s]	Force all links to L0s State.
[Auto]	BIOS auto configure.
[Disabled]	Disables ASPM.



Enabling ASPM may cause some PCI-E devices to fail.

Extended Synch [Disabled]

This option allows the generation of Extended Synchronization patterns when set to **Enabled**.

Configuration options: [Disabled] [Enabled]

Link Training Retry [5]

This option allows you to set the number of Retry Attempts software will take to retrain the link if previous training attempt was unsuccessful.

Configuration options: [Disabled] [2] [3] [5]

Link Training Timeout [1000]

This option allows you to set the number of Microseconds software will wait before polling 'Link Training' but in Link Status Register. The value ranges from 10 to 10000 uS.

Unpopulated Links [Keep Link On]

This option will disable unpopulated PCI Express links to save power when set to Disabled.

Configuration options: [Disabled] [Keep Link On]

PCI Express Gen 2 Settings

PCI Express GEN2 Device Register Settings

Completion Timeout [Default]

This option allows system software to modify the Completion Timeout value for device Functions which support Completion Timeout programmability.

[Default]	50us to 50ms.
[Shorter]	Shorter timeout ranges supported by hardware will be used.
[Longer]	Longer timeout ranges supported by hardware will be used.
[Disabled]	Disable Completion Timeout.

ARI Forwarding [Disabled]

If supported by hardware and set to Enabled, the Downstream Port disables its traditional Device Number field being 0 enforcement when turning a Type1 Configuration Request into a Type0 Configuration Request, permitting access to Extended Functions in an ARI Device immediately below the Port.

Configuration options: [Disabled] [Enabled]

Atomic0p Requester Enable [Disabled]

If supported by hardware and set to Enabled, this function initiates Atomic0p Requests only if Bus Master Enable bit is in the Command Register Set.

Configuration options: [Disabled] [Enabled]

Atomic0p Egress Blocking [Disabled]

If supported by hardware and set to Enabled, outbound Atomic0p Requests via Egress Ports will be blocked.

Configuration options: [Disabled] [Enabled]

IDO Request Enable [Disabled]

If supported by hardware and set to Enabled, this permits setting the number of ID-Based Ordering (IDO) bit (Attribute[2]) requests to be initiated.

Configuration options: [Disabled] [Enabled]

IDO Completion Enable [Disabled]

If supported by hardware and set to Enabled, this permits setting the number of ID-Based Ordering (IDO) bit (Attribute[2]) requests to be initiated.

Configuration options: [Disabled] [Enabled]

LTR Mechanism Enable [Disabled]

If supported by hardware and set to Enabled, this enables the Latency Tolerance Reporting (LTR) Mechanism.

Configuration options: [Disabled] [Enabled]

End-End TLP Prefix Blocking [Disabled]

If supported by hardware and set to Enabled, this function will block forwarding of TLPs containing End-End TLP Prefixes.

Configuration options: [Disabled] [Enabled]

PCI Express GEN2 Device Register Settings

Target Link Speed [Auto]

If supported by hardware and set to Force to X.X GT/s, for Downstream Ports, this sets an upper limit on Link operational speed by restricting the values advertised by the Upstream component in its training sequences. When Auto is selected HW initialized data will be used.

Configuration options: [Auto] [Force to 2.5 GT/s] [Force to 5.0 GT/s] [Force to 8.0 GT/s]

Clock Power Management [Disabled]

If supported by hardware and set to Enabled, the device is permitted to use CLKREQ# signal for power management of Link clock in accordance to protocol defined in appropriate form factor specification.

Configuration options: [Disabled] [Enabled]

Compliance SOS [Disabled]

If supported by hardware and set to Enabled, this will force LTSSM to send SKP Ordered Sets between sequences when sending Compliance Pattern or Modified Compliance Pattern.

Configuration options: [Disabled] [Enabled]

Hardware Autonomous Width [Enabled]

If supported by hardware and set to Disabled, this will disable the hardware's ability to change link width except for width size reduction for the purpose of correcting unstable link operation.

Configuration options: [Disabled] [Enabled]

Hardware Autonomous Speed [Enabled]

If supported by hardware and set to Disabled, this will disable the hardware's ability to change link speed except for speed rate reduction for the purpose of correcting unstable link operation.

Configuration options: [Disabled] [Enabled]

PCIe OPROM Slot Options

PCIe1 Slot OpROM [Enabled]

This option allows you to enable or disable the OpROM of the PCIe slots.

Configuration options: [Disabled] [Enabled]

5.5.9 Network Stack Configuration

Allows you to configure the network stack configuration.

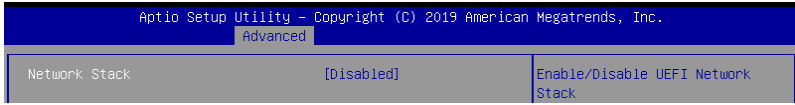

Network Stack [Disabled]

Allows you to enable or disable UEFI Network Stack.

Configuration options: [Disabled] [Enabled]



The following items appear only when you set **Network Stack** to **[Enabled]**.

Ipv4 PXE Support [Disabled]

Enables or disables the Ipv4 PXE Boot Support. If disabled, Ipv4 PXE boot option will not be created.

Configuration options: [Disable] [Enable]

Ipv4 HTTP Support [Disabled]

Enables or disables the Ipv4 HTTP Boot Support. If disabled, Ipv4 PXE boot option will not be created.

Configuration options: [Disable] [Enable]

Ipv6 PXE Support [Disabled]

Enables or disables the Ipv6 PXE Boot Support. If disabled, Ipv6 PXE boot option will not be created.

Configuration options: [Disable] [Enable]

Ipv6 HTTP Support [Disabled]

Enables or disables the Ipv6 HTTP Boot Support. If disabled, Ipv6 PXE boot option will not be created.

Configuration options: [Disable] [Enable]

PXE boot wait time [0]

Set the wait time to press ESC key to abort the PXE boot. Use the <+> or <-> to adjust the value. The values range from 0 to 5.

Media detect count [1]

Set the number of times presence of media will be checked. Use the <+> or <-> to adjust the value. The values range from 1 to 50.

5.5.10 CSM Configuration

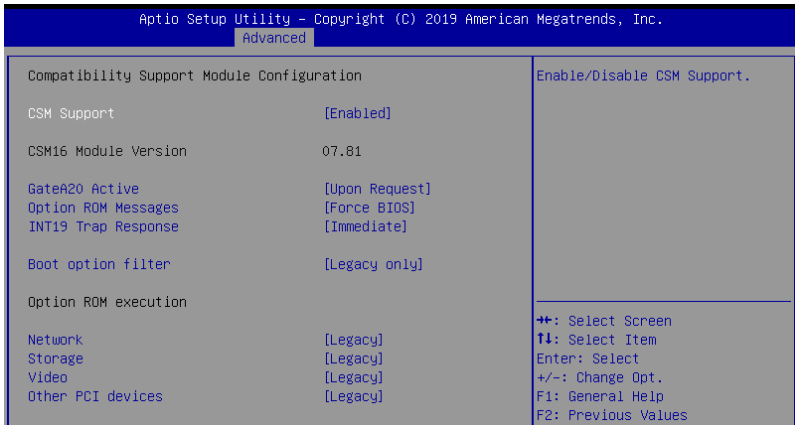

CSM Support [Enabled]

This option allows you to enable or disable CSM Support.

Configuration options: [Disabled] [Enabled]



The following items appear only when you set **CSM Support** to [Enabled].

GateA20 Active [Upon Request]

This allows you to set the GA20 option.

- [Upon Request] GA20 can be disabled using BIOS services.
- [Always] Do not allow disabling GA20; this option is useful when any RT code is executed above 1MB.

Option ROM Messages [Force BIOS]

This allows you to set the display mode for option ROM.

Configuration options: [Force BIOS] [Keep Current]

INT19 Trap Response [Immediate]

This option allows you to control the BIOS reaction on INT19 trapping by Option ROM.

- [Immediate] Execute the trap right away.
- [Postponed] Execute the trap during legacy boot.
- [Auto] Allow the system to determine automatically.

Boot Option filter [Legacy only]

This option allows you to control the Legacy/UEFI ROMs priority.

Configuration options: [UEFI and Legacy] [Legacy only] [UEFI only]

Network / Storage / Video [Legacy]

This option allows you to control the execution of UEFI and Legacy PXE/ Storage/ Video OpROM.

Configuration options: [UEFI] [Legacy]

Other PCI devices [Legacy]

This item determines the OpROM execution policy for devices other than Network, Storage, or Video.

Configuration options: [UEFI] [Legacy]

5.5.11 NVMe Configuration

You may view the NVMe controller and Drive information if an NVMe device is connected.

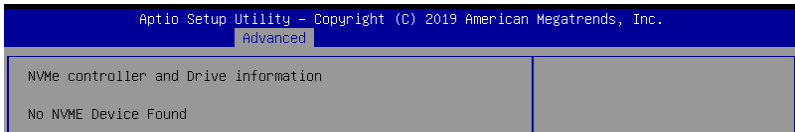

5.5.12 USB Configuration

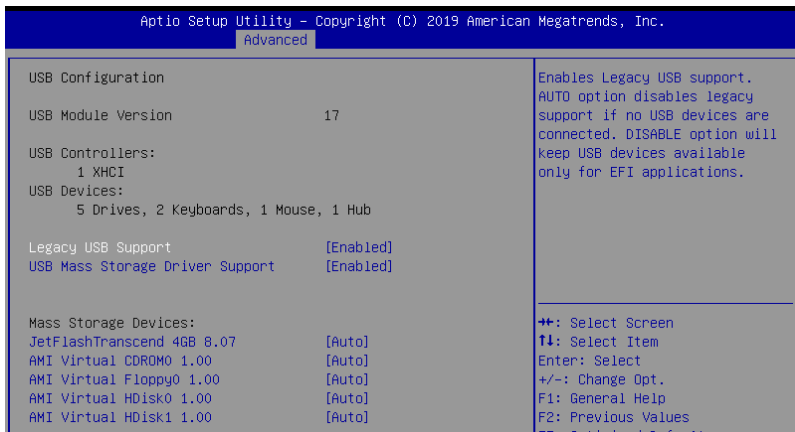

Legacy USB Support [Enabled]

[Disabled] The USB devices can be used only for the BIOS setup program. It cannot be recognized in boot devices list.

[Enabled] Enables the support for USB devices on legacy operating systems (OS).

[Auto] Allows the system to detect the presence of USB devices at startup. If detected, the USB controller legacy mode is enabled. If no USB device is detected, the legacy USB support is disabled.

USB Mass Storage Driver Support [Enabled]

Allows you to enable or disable the USB Mass Storage driver support.

Configuration options: [Disabled] [Enabled]

Mass Storage Devices

Allows you to select the mass storage device emulation type for devices connected.

Configuration options: [Auto] [Floppy] [Forced FDD] [Hard Disk] [CD-ROM]

5.5.13 Vcore Adjust

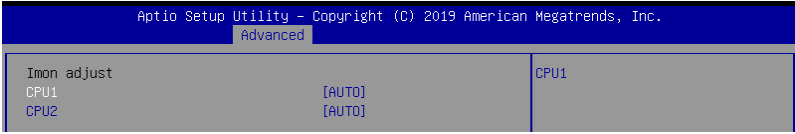

CPU1 / CPU2

Configuration options: [AUTO] [0.3438] [0.3320] [0.3203] [0.3086] [0.3008] [0.2969] [0.2852] [0.2734] [0.2617] [0.2500] [0.2383] [0.2266] [0.2148] [0.2031]

5.5.14 iSCSI Configuration

Allows you to configure the iSCSi parameters.

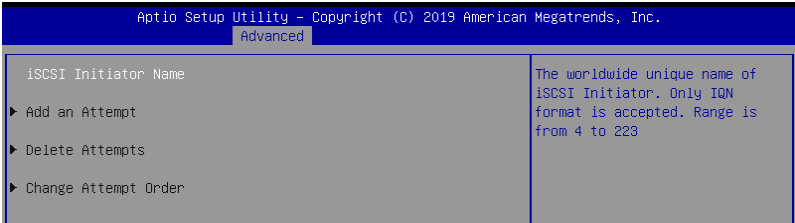

5.5.15 Intel(R) Virtual RAID on CPU

Allows you to configure the view the RAID volumes and VMD controllers on the system.

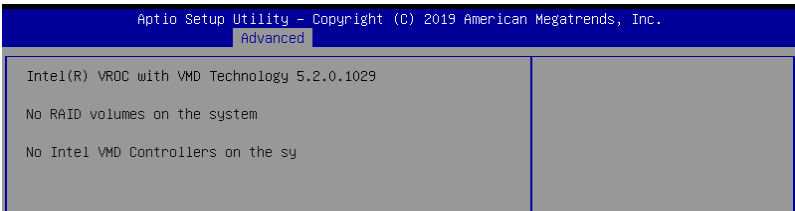

5.6 Platform Configuration menu

The IntelRCSetup menu items allow you to change the platform settings.

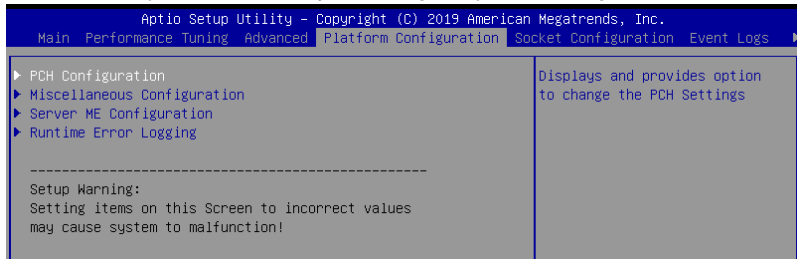

Take caution when changing the settings of the Platform Configuration menu items. Incorrect field values can cause the system to malfunction.

5.6.1 PCH Configuration

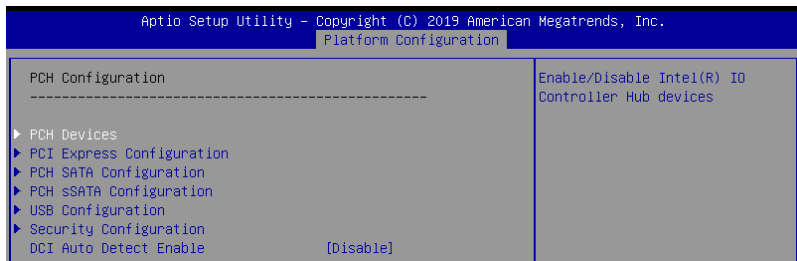

PCH Devices

Board Capability [DeepSx]

[SUS_PWR_DN_ACK] Send Disabled to PCH.
[DeepSx] Show DeepSx Policies.

DeepSx Power Policies [Disabled]

Allows you to configure the DeepSx Mode configuration.
Configuration options: [Disabled] [Enabled in S5] [Enabled in S4 and S5]

GP27 Wake From DeepSx [Disabled]

Allows you to enable or disable GP27 Wake From DeepSx.
Configuration options: [Disabled] [Enabled]

PCI Express Configuration

PCI-E ASPM Support (Global) [L1 Only]

Allows you to select ASPM support for all downstream devices.
Configuration options: [Per individual port] [L1 Only]

PCH DMI ASPM [Platform-POR]

Allows you to configure the PCH DMI ASPM.
Configuration options: [Platform-POR] [ASPM L1] [Disabled]

USB Configuration

USB Precondition [Disabled]

Allows you to enable or disable precondition work on USB host controller and root ports for faster enumeration.

Configuration options: [Disabled] [Enabled]

XHCI Manual Mode [Disabled]

This option is used by validation.

Configuration options: [Disabled] [Enabled]



The following items appear only when **XHCI Manual Mode** is set to **[Enabled]**.

Trunk Clock Gating (BTCG) [Enabled]

Allows you to enable or disable BTCG.

Configuration options: [Disabled] [Enabled]

Enable USB 3.0 pins [Disable all pins]

Allows you to enable or disable USB 3.0 pins or on a per pin basis.

Configuration options: [Select Per-Pin] [Disable all pins] [Enable all pins]

USB Per-Connector Disable [Disabled]

Allows you to enable or disable each of the USB physical connectors. Once a connector is disabled, any USB devices plugged into the connector will not be detected by BIOS or OS.

Configuration options: [Disabled] [Enabled]



The following items appear only when **USB Per-Connector Disable** is set to **[Enabled]**.

USB_1-2 [Enabled]

Configuration options: [Disabled] [Enabled]

USB3_1-2 [Enabled]

Configuration options: [Disabled] [Enabled]

Security Configuration

SMM BIOS Write Protect [Enabled]

Allows you to enable or disable SMM BIOS Write Protect.

Configuration options: [Disabled] [Enabled]

DCI Auto Detect Enable [Disabled]

When enabled, it detects DCI being connected during BIOS POST time and enables DCI.

Configuration options: [Disabled] [Enabled]

5.6.2 Miscellaneous Configuration

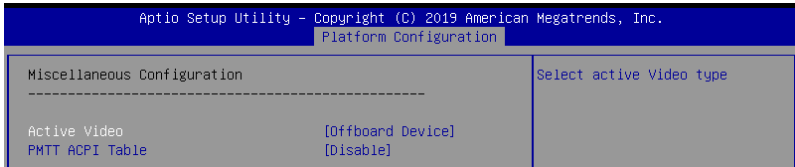

Active Video [Offboard Device]

Allows you to select the video type.

Configuration options: [Onboard Device] [Offboard Device]

PMTT ACPI Table [Disabled]

Allows you to enable or disable PMTT ACPI Table for DDR4 only.

Configuration options: [Disabled] [Enabled]

5.6.3 Server ME Configuration

Displays the Server ME Technology parameters on your system.

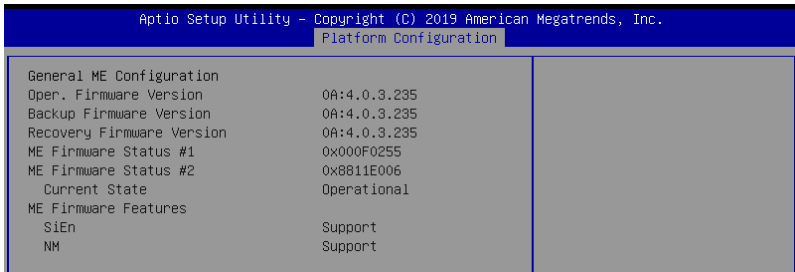

Navigate to the second page of the screen to see the rest of items in this menu by pressing the Up or Down arrow keys.



To quickly go to the last item of the second page, press the **Page Down** button. Press the **Page Up** button to go back to the first item in the first page.

5.6.4 Runtime Error Logging

Displays the Server ME Technology parameters on your system.

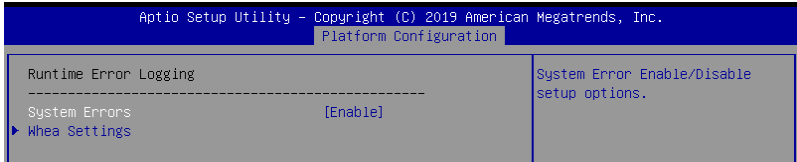

System Errors [Enabled]

This item allows you to enable or disable System Errors.

Configuration options: [Disabled] [Enabled]



The following item is configurable only when **System Errors** is set to **[Enabled]**.

Whea Settings

Whea Support [Enabled]

This item allows you to enable or disable the WHEA support.

Configuration options: [Disabled] [Enabled]

5.7 Socket Configuration menu

The IntelRCSetup menu items allow you to change the socket settings.

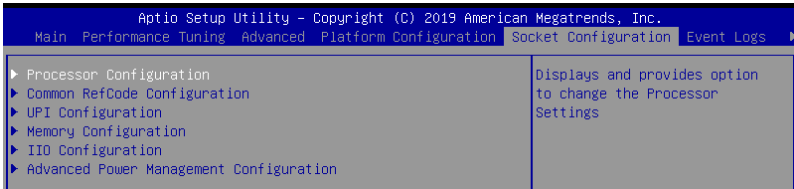

5.7.1 Processor Configuration

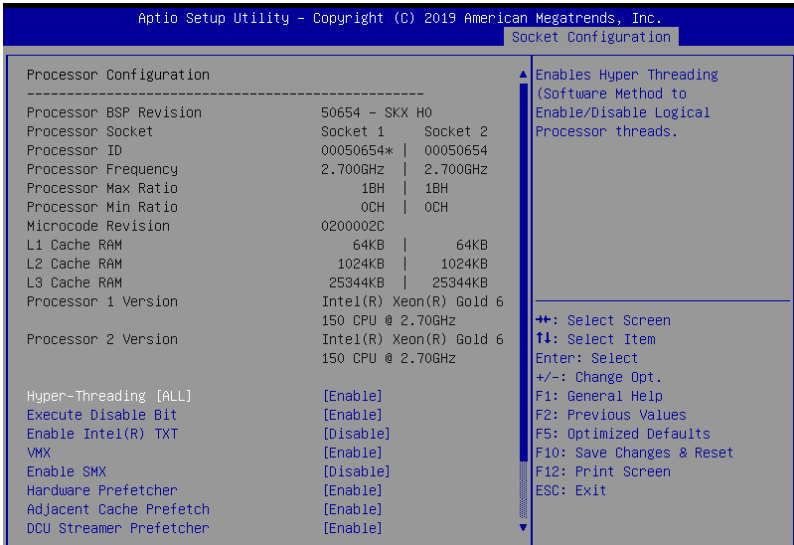

Navigate to the second page of the screen to see the rest of items in this menu by pressing the Up or Down arrow keys.



To quickly go to the last item of the second page, press the **Page Down** button. Press the **Page Up** button to go back to the first item in the first page.

Hyper-threading [ALL] [Enabled]

This item allows a hyper-threading processor to appear as two logical processors, allowing the operating system to schedule two threads or processors simultaneously.

Configuration options: [Disabled] [Enabled]

Execute Disable Bit [Enabled]

XD can prevent certain classes of malicious buffer overflow attacks when combined with a supporting OS (Windows Server 2003 SP1, Windows XP SP2, SuSE Linux 9.2, Redhat Enterprise 3 Update 3).

Configuration options: [Disabled] [Enabled]

Enable Intel(R) TXT [Disabled]

Forces the XD feature log to always return 0 when disabled.

Configuration options: [Disabled] [Enabled]

VMX [Enabled]

Enables the Vanderpool Technology. Takes effect after reboot.

Configuration options: [Disabled] [Enabled]

Enable SMX [Disabled]

Enables the Safer Mode Extensions.

Configuration options: [Disabled] [Enabled]

Hardware Prefetcher [Enabled]

This Item allows you to turn on/off the mid level cache(L2) streamer prefetcher.

Configuration options: [Disabled] [Enabled]

Adjacent Cache Prefetch [Enabled]

This Item allows you to turn on/off prefetching of adjacent cache lines.

Configuration options: [Disabled] [Enabled]

DCU Streamer Prefetcher [Enabled]

This Item allows you to enable or disable prefetcher of next L1 data line.

Configuration options: [Disabled] [Enabled]

DCU IP Prefetcher [Enabled]

This Item allows you to enable or disable prefetch of next L1 line based upon sequential load history.

Configuration options: [Disabled] [Enabled]

LLC Prefetch [Disabled]

This Item allows you to enable or disable LLC Prefetch on all threads.

Configuration options: [Disabled] [Enabled]

DCU Mode [32KB 8Way Without ECC]

Configuration options: [32KB 8Way Without ECC] [16KB 4Way With ECC]

Extended APIC [Disabled]

This Item allows you to enable or disable the extended APIC support.

Configuration options: [Disabled] [Enabled]

AES-NI [Enabled]

This Item allows you to enable or disable the AES-NI support.

Configuration options: [Disabled] [Enabled]

5.7.2 Common RefCode Configuration

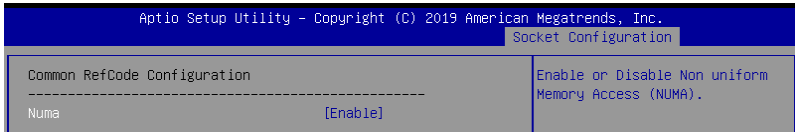

Numa [Enabled]

This item enables or disables the Non uniform Memory Access (NUMA).
Configuration options: [Disabled] [Enabled]

5.7.3 UPI Configuration

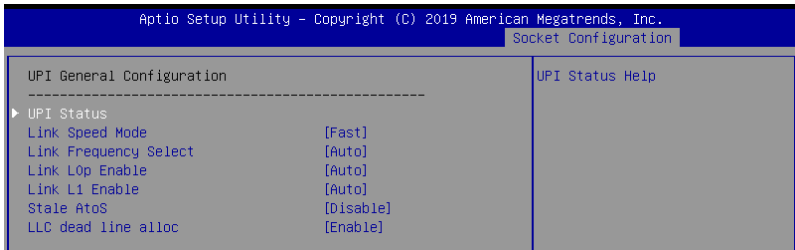

UPI General Configuration

UPI Status

This item displays information about the UPI status.

Link Speed Mode [Fast]

This item allows you to select the UPI link speed as either the fast mode or slow mode.
Configuration options: [Slow] [Fast]

Link Frequency Select [Auto]

This item allows for selecting the UPI link frequency.
Configuration options: [Auto] [9.6 GB/s] [10.4 GB/s] [Use Per Link Setting]

Link L0p Enable [Auto]

Configuration options: [Disabled] [Enabled] [Auto]

Link L1 Enable [Auto]

Configuration options: [Disabled] [Enabled] [Auto]

Stale AtoS [Disabled]

Configuration options: [Disabled] [Enabled] [Auto]

LLC dead line alloc [Enabled]

Configuration options: [Disabled] [Enabled] [Auto]

5.7.4 Memory Configuration

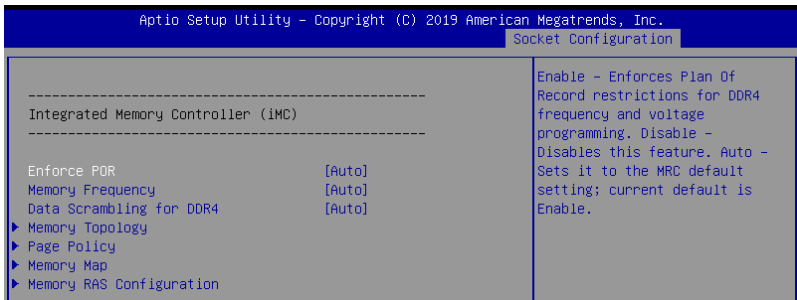

Enforce POR [Auto]

Allows you to enforce POR restrictions for DDR4 frequency and voltage programming.
Configuration options: [Auto] [POR] [Disabled]

Memory Frequency [Auto]

Allows you to select the memory frequency setting.
Configuration options: [Auto] [2133] [2400] [2666]

Data Scrambling for DDR4 [Auto]

Allows you to enable or disable data scrambling.
Configuration options: [Auto] [Disabled] [Enabled]

Memory Topology

Displays memory topology with DIMM population information.

Page Policy

Allows you to configure Page Policy settings.

Page Policy [Auto]

Configuration options: [Auto] [Closed] [Adaptive]

Memory Map

IMC Interleaving [Auto]

Select different IMC interleaving setting.

Configuration options: [Auto] [1-way Interleave] [2-way Interleave]

Channel Interleaving [Auto]

Select different channel interleaving setting.

Configuration options: [Auto] [1-way Interleave] [2-way Interleave] [3-way Interleave]

Rank Interleaving [Auto]

Select different rank interleaving setting.

Configuration options: [Auto] [1-way Interleave] [2-way Interleave] [4-way Interleave] [8-way Interleave]

Memory RAS Configuration

Mirror mode [Disabled]

Allows you to select Mirror modes. Mirror mode will set entire 1LM/2LM memory in system to be mirrored, consequently reducing the memory capacity by half. Enabling Mirror mode will disable XPT Prefetch.

Configuration options: [Disabled] [Mirror Mode 1LM] [Mirror Mode 2LM]

Mirror TAD0 [Disabled]

Allows you to enable or disable Mirror on entire memory for TAD0.

Configuration options: [Disabled] [Enabled]

Enable Partial Mirror [Disabled]

Partial mirror mode will enable the required size of memory to be mirrored. If rank sparing is enabled, partial mirroring will not take effect. Mirror Enable will disable XPT Prefetch.

Configuration options: [Disabled] [Enabled]

UEFI ARM Mirror [Disabled]

Allows you to enable or disable UEFI ARM Mirror.

Configuration options: [Disabled] [Enabled]

Memory Rank Sparing [Disabled]

Allows you to enable or disable Memory Rank Sparing

Configuration options: [Disabled] [Enabled]

Patrol Scrub [Enabled]

Allows you to enable or disable Patrol Scrub.

Configuration options: [Disabled] [Enabled]

5.7.5 IIO Configuration

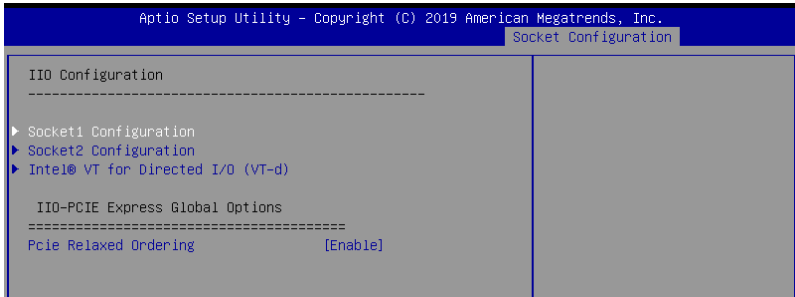

Socket1-2 Configuration

This option allows you to change the settings related to the PCI Express Ports.

Intel® VT for Directed I/O (VT-d)

Intel® VT for Directed I/O (VT-d) [Enabled]

Allows you to enable or disable the Intel Virtualization Technology for Directed I/O.

Configuration options: [Disabled] [Enabled]

IIO-PCIE Express Global Options

PCIE relaxed Ordering [Enabled]

Allows you to enable or disable PCIE relaxed Ordering.

Configuration options: [Disabled] [Enabled]

5.7.6 Advanced Power Management Configuration

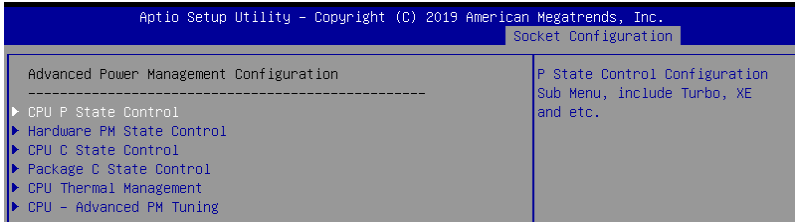

CPU P State Control

Boot performance mode [Max Performance]

Allows you to switch between Boot performance mode.

Configuration options: [Max Performance] [Max Efficient] [Set by Intel Node Manager]

Energy Efficient Turbo [Enabled]

Allows you to enable or disable Energy Efficient Turbo.

Configuration options: [Disabled] [Enabled]

Turbo Mode [Enabled]

Allows you to enable or disable Turbo Mode.

Configuration options: [Disabled] [Enabled]

Hardware PM State Control

Hardware P-States [Native Mode]

Allows you to switch between Hardware P-States mode.

Configuration options: [Disabled] [Native Mode] [Out of Band Mode]

[Native Mode with no Legacy Support]

CPU C State Control

Autonomous Core C-State [Disabled]

Allows you to enable or disable Autonomous Core C-State Report.

Configuration options: [Disabled] [Enabled]

CPU C6 Report [Auto]

Allows you to select CPU C6 Report.

Configuration options: [Disabled] [Enabled] [Auto]

OS ACPI Cx [ACPI C2]

Allows you to select OS ACPI Cx Report.

Configuration options: [ACPI C2] [ACPI C3]

Package C State Control

Package C State [Auto]

Allows you to select Package C State.

Configuration options: [C0/C1 state] [C3 state] [C6(non Retention) state] [C6(Retention) state] [No Limit] [Auto]

CPU Thermal Management

CPU T State Control

Software Controlled T-States [Disabled]

Allows you to enable or disable Software Controlled T-States.

Configuration options: [Disabled] [Enabled]



The following item appears only when **Software Controlled T-States** is set to **[Enabled]**.

T-State Throttle Level [Disabled]

Allows you to set the T-State Throttle level.

CPU - Advanced PM Tuning

Energy Perf BIAS

Power Performance Tuning [OS Controls EPB]

Configuration options: [OS Controls EPB] [BIOS Controls EPB]



The following item appears only when **Power Performance Tuning** is set to **[OS Controls EPB]**.

PECI PCS EPB [OS Controls EPB]

This option controls whether Peci has control over EPB.

Configuration options: [OS Controls EPB] [PECI Controls EPB using PCS]



The following item appears only when **Power Performance Tuning** is set to **[BIOS Controls EPB]**.

ENERGY_PERF_BIAS_CFG Mode [Balanced Performance]

Configuration options: [Performance] [Balanced Performance] [Balanced Power] [Power]

Dynamic Loadline Switch [Enabled]

Configuration options: [Disabled] [Enabled]

Workload Configuration [UMA]

This option allows optimization for the workload characterization.

Configuration options: [UMA] [NUMA]

Averaging Time Window [17]

This option is used to control the effective window of the average C0 an P0 time.

Configuration options: [0] - [99]

P0 TotalTimeThreshold Low [23]

The HW switching mechanism **DISABLES** the performance setting (0) when the total P0 time is less than the threshold set.

Configuration options: [0] - [99]

P0 TotalTimeThreshold High [3a]

The HW switching mechanism **Enables** the performance setting (0) when the total P0 time is greater than the threshold set.

Configuration options: [0] - [99]

5.8 Event Logs menu

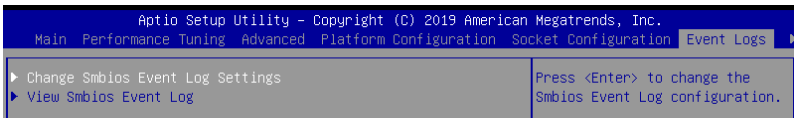

5.8.1 Change Smbios Event Log Settings

Press <Enter> to change the Smbios Event Log configuration.

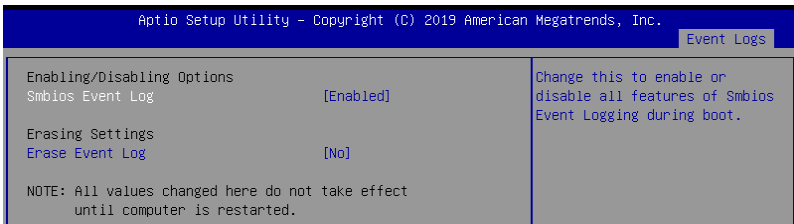

All values changed here do not take effect until computer is restarted.

Enabling/Disabling Options

Smbios Event Log [Enabled]

Change this to enable or disable all features of Smbios Event Logging during boot.

Configuration options: [Disabled] [Enabled]

Erasing Settings

Erase Event Log [No]

Choose options for erasing Smbios Event Log. Erasing is done prior to any logging activation during reset.

Configuration options: [No] [Yes, Next reset] [Yes, Every reset]

5.8.2 View Smbios Event Log

Press <Enter> to view all smbios event logs.

5.9 Server Mgmt menu

Aptio Setup Utility - Copyright (C) 2019 American Megatrends, Inc.			
Server Mgmt Security Boot Tool Save & Exit			
BMC Self Test Status	PASSED	If enabled, starts a BIOS timer which can only be shut off by Management Software after the OS loads. Helps determine that the OS successfully loaded or follows the OS Boot Watchdog Timer policy.	
BMC Device ID	32		
BMC Device Revision	1		
BMC Firmware Revision	1.11		
IPMI Version	2.0		
Current Time Zone	-05:00 GMT		
OS Watchdog Timer	[Disabled]		
OS Wtd Timer Timeout	[10 minutes]		
OS Wtd Timer Policy	[Reset]		
▶ System Event Log			
▶ BMC network configuration			
▶ View System Event Log			

OS Watchdog Timer [Disabled]

This item allows you to start a BIOS timer which can only be shut off by Intel Management Software after the OS loads.

Configuration options: [Disabled] [Enabled]



The following items are configurable only when **OS Watchdog Timer** is set to **[Enabled]**.

OS Wtd Timer Timeout [10 minutes]

Allows you to configure the length for the OS Boot Watchdog Timer.

Configuration options: [5 minutes] [10 minutes] [15 minutes] [20 minutes]

OS Wtd Timer Policy [Reset]

This item allows you to configure the how the system should respond if the OS Boot Watch Timer expires.

Configuration options: [Do Nothing] [Reset] [Power Down]

5.9.1 System Event Log

Allows you to change the SEL event log configuration.

Aptio Setup Utility - Copyright (C) 2019 American Megatrends, Inc.		
Server Mgmt		
Erase SEL	[No]	Choose options for erasing SEL.
When SEL is Full	[Do Nothing]	
NOTE: All values changed here do not take effect until computer is restarted.		



All values changed here do not take effect until computer is restarted.

Erase SEL [No]

Allows you to choose options for erasing SEL.

Configuration options: [No] [Yes, On next reset] [Yes, On every reset]

When SEL is Full [Do Nothing]

Allows you to choose options for reactions to a full SEL.

Configuration options: [Do Nothing] [Erase Immediately]

5.9.2 BMC network configuration

The sub-items in this configuration allow you to configure the BMC network parameters.

```
Aptio Setup Utility - Copyright (C) 2019 American Megatrends, Inc.
Server Mgmt
--BMC network configuration--
*****
Configure IPV4 support
*****
DM_LAN1
Config Address source          [Previous State]
Current Config Address source  DHCP Mode
IP Address in BMC :            0.0.0.0
Subnet Mask in BMC :           0.0.0.0
Station MAC address            30-5a-3a-c8-22-c2
Gateway IP address             0.0.0.0

Shared LAN
Config Address source          [Previous State]
Current Config Address source  DHCP Mode
IP Address in BMC :            0.0.0.0
Subnet Mask in BMC :           0.0.0.0
Station MAC address            30-5a-3a-c8-22-c3
Gateway IP address             0.0.0.0

*****
Configure IPV6 support
*****

Select to configure LAN
channel parameters statically
or dynamically (by BIOS or
BMC). Previous State option
will not modify any BMC
network parameters during BIOS
phase

+-: Select Screen
↑↓: Select Item
Enter: Select
+/-: Change Opt.
F1: General Help
F2: Previous Values
F5: Optimized Defaults
F10: Save Changes & Reset
F12: Print Screen
ESC: Exit
```

Navigate to the second page of the screen to see the rest of items in this menu by pressing the Up or Down arrow keys.



To quickly go to the last item of the second page, press the **Page Down** button. Press the **Page Up** button to go back to the first item in the first page.

IPV4

DM_LAN1/ Shared LAN

Config Address source [Previous State]

This item allows you to configure LAN channel parameters statistically or dynamically (by BIOS or BMC). Unspecified option will not modify any BMC network parameters during BIOS phase.

Configuration options: [Previous State] [Static] [DynamicBmcDhcp] [DynamicBmcNonDhcp]

IPV6

DM_LAN1/ Shared LAN

IPV6 Support [Enabled]

Allows you to enable or disable LAN1 IPV6 Support.

Configuration options: [Disabled] [Enabled]

Config Address source [Previous State]

This item allows you to configure LAN channel parameters statistically or dynamically (by BIOS or BMC). Unspecified option will not modify any BMC network parameters during BIOS phase.

Configuration options: [Previous State] [Static] [DynamicBmcDhcp] [DynamicBmcNonDhcp]

5.9.3 View System Event Log

This item allows you to view the system event log records.

5.10 Security menu

This menu allows a new password to be created or a current password to be changed. The menu also enables or disables the Secure Boot state and lets the user configure the System Mode state.

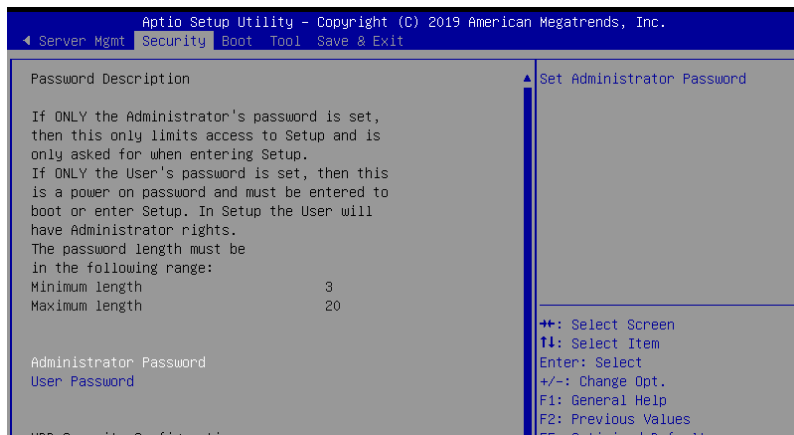

Administrator Password

To set an administrator password:

1. Select the Administrator Password item and press <Enter>.
2. From the Create New Password box, key in a password, then press <Enter>.
3. Confirm the password when prompted.

To change an administrator password:

1. Select the Administrator Password item and press <Enter>.
2. From the Enter Current Password box, key in the current password, then press <Enter>.
3. From the Create New Password box, key in a new password, then press <Enter>.
4. Confirm the password when prompted.



To clear the administrator password, follow the same steps as in changing an administrator password, but press <Enter> when prompted to create/confirm the password.

User Password

To set a user password:

1. Select the User Password item and press <Enter>.
2. From the Create New Password box, key in a password, then press <Enter>.
3. Confirm the password when prompted.

To change a user password:

1. Select the User Password item and press <Enter>.
2. From the Enter Current Password box, key in the current password, then press <Enter>.
3. From the Create New Password box, key in a new password, then press <Enter>.
4. Confirm the password when prompted.

To clear a user password:

1. Select the Clear User Password item and press <Enter>.
2. Select Yes from the Warning message window then press <Enter>.

Secure Boot

This item allows you to customize the Secure Boot settings.

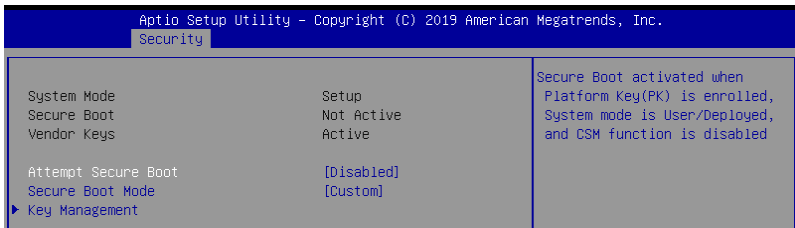

Attempt Secure Boot [Disabled]

Secure Boot can be enabled if the system is running in User mode with enrolled platform Key (EPK) or if the CSM function is disabled.

Configuration options: [Disabled] [Enabled]

Secure Boot Mode [Custom]

Allows you to set the Secure Boot selector.

Configuration options: [Custom] [Standard]

Key Management

This item only appears when the item Secure Boot Mode is set to [Custom]. The Key Management item allows you to modify Secure Boot variables and set Key Management page.

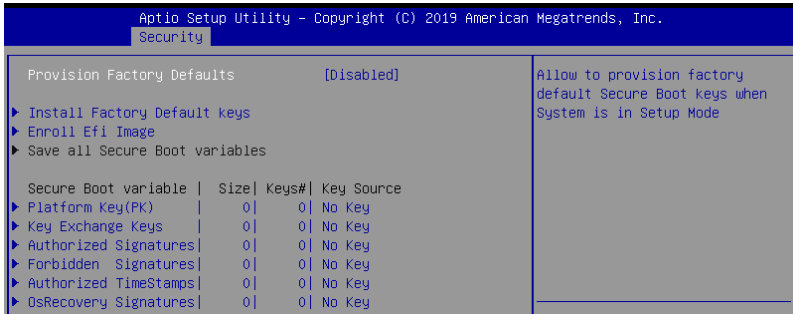

Provision Factory Defaults [Disabled]

Allows you to provision factory default Secure Boot keys when the system is in Setup Mode.

Configuration options: [Disabled] [Enabled]

Install Factory Default keys

This item will install all Factory Default keys.

Reset to Setup Mode

This item appears only when you load the default Secure Boot keys. This item allows you to clear all default Secure Boot keys.

Enroll Efi Image

This item will allow the image to run in Secure Boot mode.

Save All Secure Boot Variables

This item will ask you if you want to save all secure boot variables. Select Yes if you want to save all secure boot variables, otherwise select No.

Platform Key (PK)

Configuration options: [Save to File] [Set New] [Erase]

Key Exchange Keys / Authorized Signatures / Forbidden Signatures

Configuration options: [Save to File] [Set New] [Append] [Erase]

Authorized TimeStamps

Configuration options: [Set New] [Append]

OsRecovery Signatures

Configuration options: [Set New] [Append]

5.11 Boot menu

The Boot menu items allow you to change the system boot options.

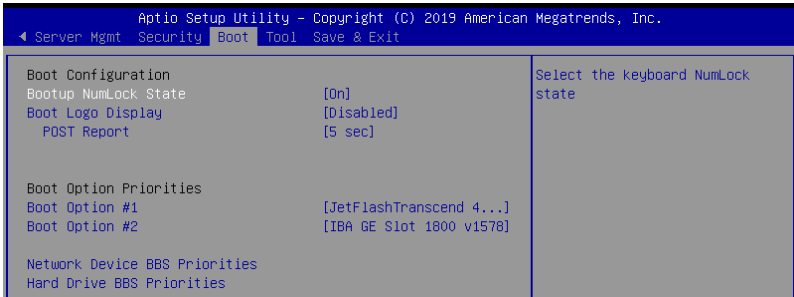

Bootup NumLock State [On]

Allows you to select the power-on state for the NumLock.

Configuration options: [Off] [On]

Boot Logo Display [Disabled]

Allows you to enable or disable the full screen logo display feature.

Configuration options: [Auto] [Full Screen] [Disabled]



The following item appears only when **Boot Logo Display** is set to **[Disabled]**.

POST Report [5 sec]

Allows you to set the desired POST Report waiting time from 1 to 10 seconds.

Configuration options: [1 sec] ~ [10 sec] [Until Press ESC]

Boot Option Priorities

These items specify the boot device priority sequence from the available devices. The number of device items that appears on the screen depends on the number of devices installed in the system.



-
- To select the boot device during system startup, press <F8> when ASUS Logo appears.
 - To access Windows OS in Safe Mode, please press <F8> after POST.
-

Network Device BBS Priorities / Hard Drive BBS Priorities

These items allow you to set the booting order of the devices.

5.12 Tool menu

The Tool menu items allow you to configure options for special functions. Select an item then press <Enter> to display the submenu.

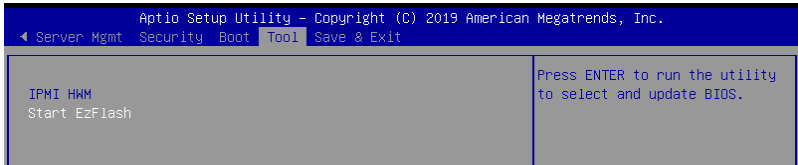

IPMI HWM

Allows you to run the IPMI hardware monitor.

Start EzFlash

Allows you to run ASUS EzFlash BIOS ROM Utility when you press <Enter>. Refer to the ASUS EzFlash Utility section for details.

5.13 Save & Exit menu

The Exit menu items allow you to save or discard your changes to the BIOS items.

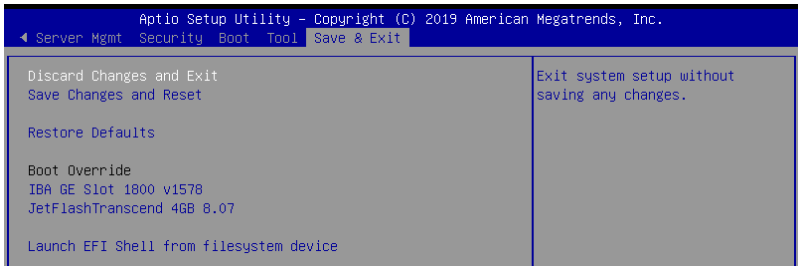

Pressing <Esc> does not immediately exit this menu. Select one of the options from this menu or <F10> from the legend bar to exit.

Discard Changes and Exit

Exit System setup without saving any changes.

Save Changes and Reset

Exit System setup after saving the changes.

Restore Defaults

Restore/load default values for all the setup options.

Boot Override

These items displays the available devices. The device items that appears on the screen depends on the number of devices installed in the system. Click an item to start booting from the selected device.

Launch EFI Shell from filesystem device

This item allows you to attempt to launch the EFI Shell application (shellx64.efi) from one of the available filesystem devices.

RAID Configuration

6

This chapter provides instructions for setting up, creating, and configuring RAID sets using the available utilities.

6.1 Setting up RAID

The motherboard supports the **Intel® Rapid Storage Technology enterprise Option ROM Utility** with RAID 0, RAID 1, RAID 10, and RAID 5 support (for Windows OS and Linux).

6.1.1 RAID definitions

RAID 0 (Data striping) optimizes two identical hard disk drives to read and write data in parallel, interleaved stacks. Two hard disks perform the same work as a single drive but at a sustained data transfer rate, double that of a single disk alone, thus improving data access and storage. Use of two new identical hard disk drives is required for this setup.

RAID 1 (Data mirroring) copies and maintains an identical image of data from one drive to a second drive. If one drive fails, the disk array management software directs all applications to the surviving drive as it contains a complete copy of the data in the other drive. This RAID configuration provides data protection and increases fault tolerance to the entire system. Use two new drives or use an existing drive and a new drive for this setup. The new drive must be of the same size or larger than the existing drive.

RAID 10 is data striping and data mirroring combined without parity (redundancy data) having to be calculated and written. With the RAID 10 configuration you get all the benefits of both RAID 0 and RAID 1 configurations. Use four new hard disk drives or use an existing drive and three new drives for this setup.

RAID 5 stripes both data and parity information across three or more hard disk drives. Among the advantages of RAID 5 configuration include better HDD performance, fault tolerance, and higher storage capacity. The RAID 5 configuration is best suited for transaction processing, relational database applications, enterprise resource planning, and other business systems. Use a minimum of three identical hard disk drives for this setup.



If you want to boot the system from a hard disk drive included in a created RAID set, copy first the RAID driver from the support DVD to a floppy disk before you install an operating system to the selected hard disk drive.

6.1.2 Installing hard disk drives

The motherboard supports Serial ATA and NVME for RAID set configuration. For optimal performance, install identical drives of the same model and capacity when creating a disk array.

To install the SATA or NVME hard disks for RAID configuration, please refer to **2.5 Storage devices** for more information.

6.1.3 RAID configuration utilities

Depending on the RAID connectors that you use, you can create a RAID set using the utilities embedded in each RAID controller. For example, use the **Intel® Rapid Storage Technology** if you installed Serial ATA hard disk drives on the Serial ATA connectors supported by the Intel® C621 chipset.

Refer to the succeeding section for details on how to use the RAID configuration utility.

6.2 Intel® Virtual Raid on CPU in BIOS

This feature allows you to do CPU RAID functions with Intel® CPU RSTe.



- Due to chipset behavior, enabling the Intel® RSTe CPU RAID functions requires an Intel® VROC hardware key module.
- Refer to section 4.3 **Internal connectors** for the location of the VROC_KEY1 connector.
- The KEY module is purchased separately.

To enter the Intel® Virtual Raid on CPU in BIOS:

1. Enter the BIOS Setup during POST.
2. Go to the **Advanced** menu > **CSM Configuration**, then press <Enter> to display the CSM Configuration menu.



Refer to Chapter 5 for details on entering and navigating through the BIOS Setup.

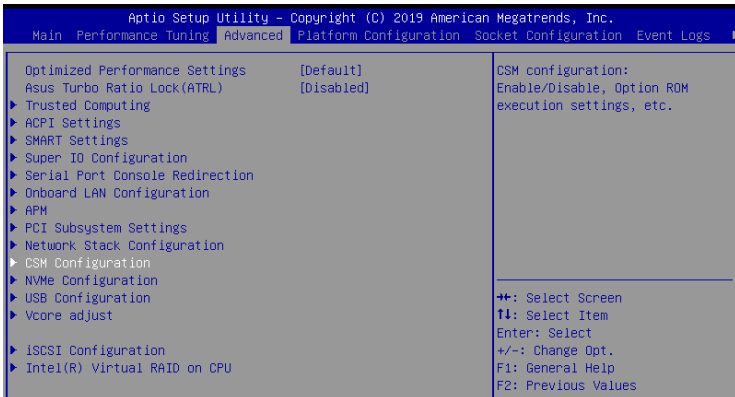

3. Select the **[Disable]** option for the CSM Support option in the CSM Configuration menu.

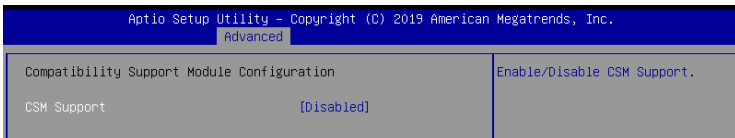

- Go to the **Save & Exit** menu > **Save Changes and Reset**, or press <F10> to save and reset.
- Enter the BIOS Setup again during POST.
- Go to the **Advanced** menu > **Intel(R) Virtual Raid on CPU** > **All Intel VMD Controllers** then press <Enter> to display the Intel® Virtual Raid on CPU menu.

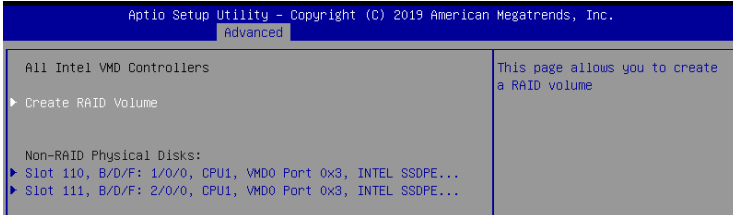

6.2.1 Creating a RAID set

To create a RAID set:

- From the Intel® Virtual Raid on CPU menu, select **Create RAID Volume** and press <Enter>. The following screen appears:

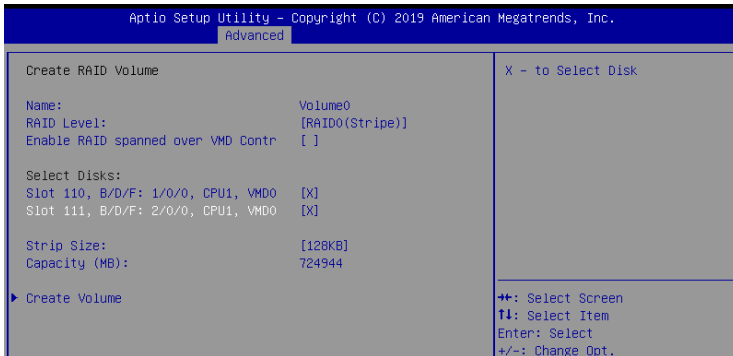

- When the **Name** item is selected, enter a name for the RAID set and press <Enter>.
- When the **RAID Level** item is selected, press <Enter> to select the RAID level to create, and then press <Enter>.
- When the **Enable RAID spanned over VMD Controllers** item is selected, press <Enter> and select **X** to enable this function.
- Under **Select Disks**, press <Enter> and select **X** for the disks you want to include in the RAID set.

6. When the **Strip Size** item is selected, press <Enter> to select strip size for the RAID array (for RAID 0, 10 and 5 only), and then press <Enter>. The available strip size values range from 4 KB to 128 KB. The following are typical values:
 - RAID 0: 128 KB
 - RAID 10: 64 KB
 - RAID 5: 64 KB



We recommend a lower strip size for server systems, and a higher strip size for multimedia computer systems used mainly for audio and video editing.

7. When the **Capacity (MB)** item is selected, enter the RAID volume capacity that you want and press <Enter>. The default value indicates the maximum allowed capacity.
8. When the **Create Volume** item is selected, press <Enter> to create the RAID volume and return to the Intel® Rapid Storage Technology menu.

6.2.2 Deleting a RAID set



Be cautious when deleting a RAID set. You will lose all data on the hard disk drives when you delete a RAID set.

To delete a RAID set:

1. From the Intel® Virtual Raid on CPU menu, select the RAID volume you want to delete and press <Enter>. The following screen appears:

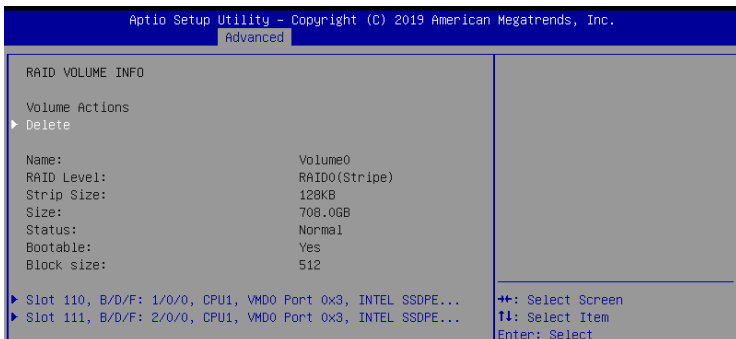

2. When the **Delete** item is selected, press <Enter>, then select **Yes** to delete the RAID volume and return to the Intel® Virtual Raid on CPU menu, or select **No** to cancel.

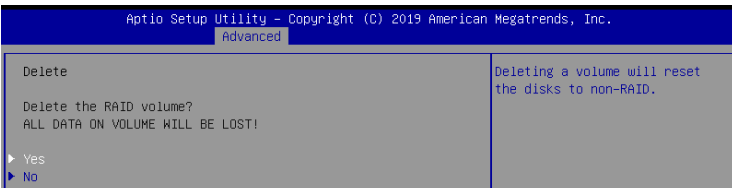

6.3 Intel® Rapid Storage Technology enterprise (Windows)

The Intel® Rapid Storage Technology enterprise allows you to create RAID 0, RAID 1, RAID 10 (RAID 1+0), and RAID 5 set(s) from Serial ATA hard disk drives that are connected to the Serial ATA connectors supported by the Southbridge.



You need to manually install the Intel® Rapid Storage Technology enterprise utility on a Windows® operating system. Please refer to the installation instructions in Chapter 7.

To enter the Intel® Rapid Storage Technology enterprise utility under Windows operating system:

1. Turn on the system and go to the windows desktop.
2. Click the **Intel® Rapid Storage Technology enterprise** icon to display the main menu.

Your storage system is configured for data protection, increased performance and optimal data storage capacity. You can create additional volumes to further optimize your storage system.

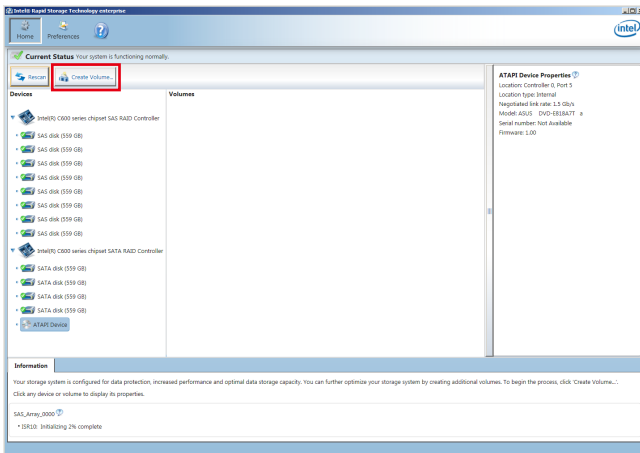

You can click **Rescan** to re-scan any attached hard disks.

6.3.1 Creating a RAID set

To create a RAID set:

1. From the utility main menu, select **Create Volume** and select volume type.
2. Click **Next**.

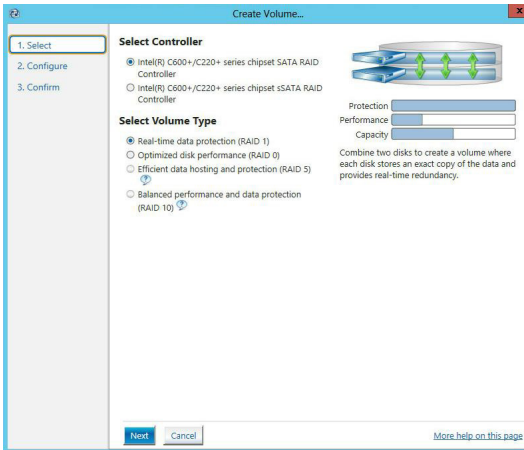

3. Enter a name for the RAID set, then select the array disks.
4. Select **Volume Size** tab, you can drag the bar to decide the volume size.
5. Click **Next**.

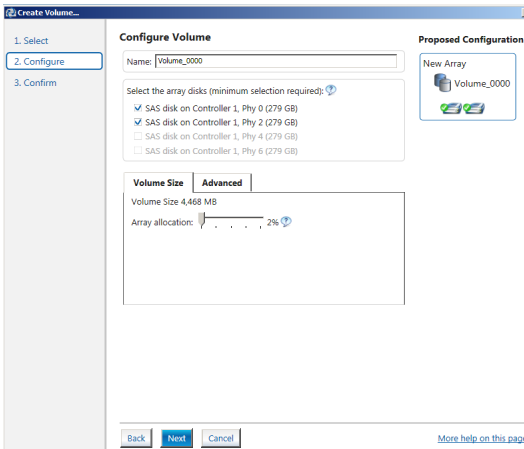

- If you do not want to keep the data on one of the selected disks, select **NO** when prompted.
- If you want to **Enable volume write-back cache** or **Initialize volume**, click **Advanced**.

6. Confirm the volume creation, then click **Create Volume** to continue.



This process could take a while depending on the number and size of the disks. You can continue using other applications during this time.

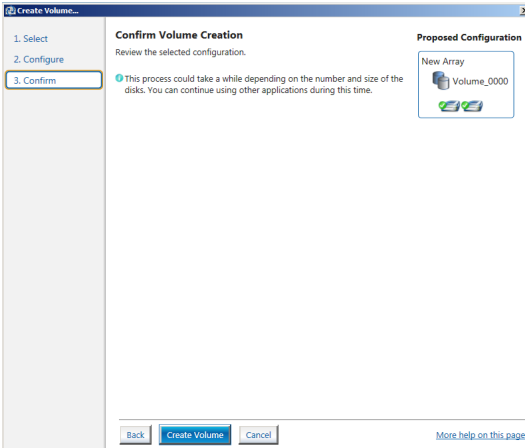

7. Wait until the process is completed, then click **OK** when prompted.

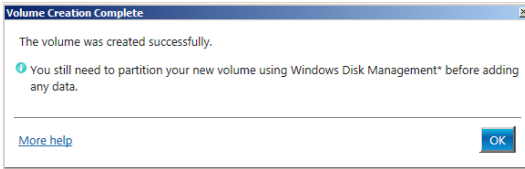

You still need to partition your new volume using Windows Disk Management before adding any data.

The RAID set is displayed in the **Volumes** list and you can change the settings in **Volume Properties**.

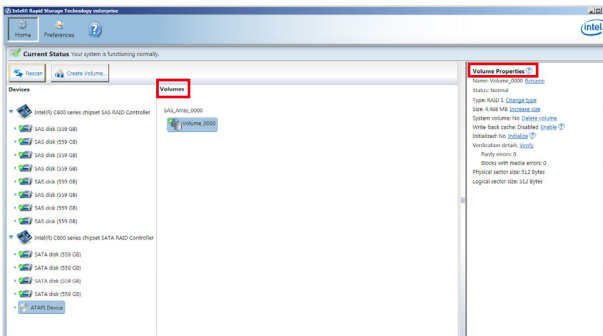

6.3.2 Changing a Volume Type

To change the volume type in **Volume Properties**:

1. Click the SATA array items you want to change in **Volumes** field.
2. From the **Volume Properties** field, select **Type: RAID 1 Change type**.

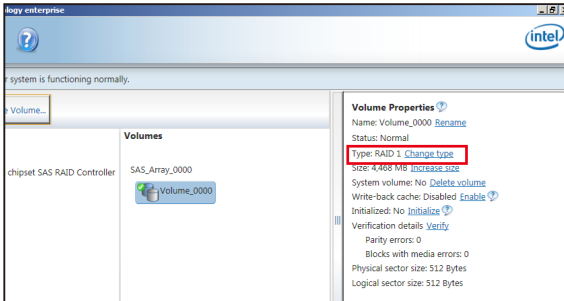

3. You can change the **Name**, **Select the new volume type**, and **Select additional disks to include in the new volume** if needed.
4. Select the **Data stripe size** for the RAID array (for RAID 0, 10 and 5 only), and click **OK**. The available stripe size values range from 4 KB to 128 KB. The following are typical values:
RAID 0: 128KB
RAID 10: 64KB
RAID 5: 64KB

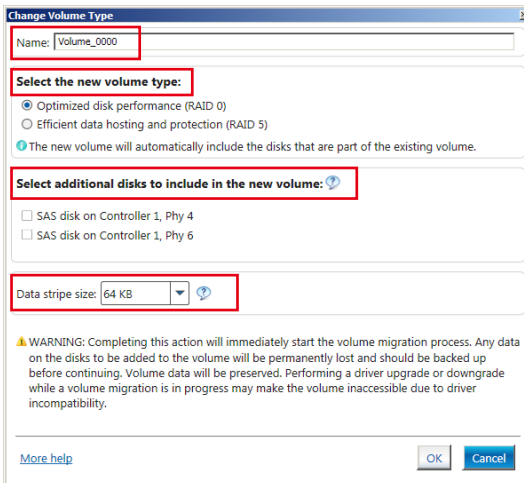

We recommend a lower stripe size for server systems, and a higher stripe size for multimedia computer systems used mainly for audio and video editing.

6.3.3 Deleting a volume



Be cautious when deleting a volume. You will lose all data on the hard disk drives. Before you proceed, ensure that you back up all your important data from your hard drives.

To delete a volume:

1. From the utility main menu, select the volume (ex. Volume_0000) in **Volumes** field you want to delete.

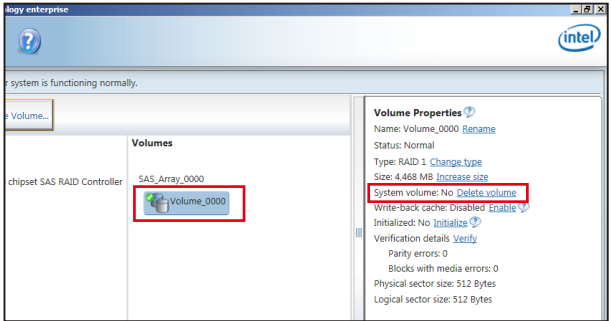

2. Select **Delete volume** in **Volume Properties** field. The following screen appears.

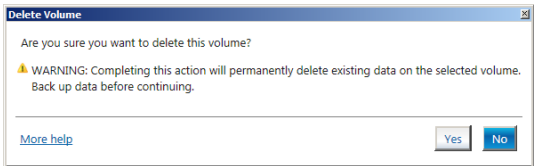

3. Click **Yes** to delete the volume and return to the utility main menu, or click **No** to return to the main menu.

6.3.4 Preferences

System Preferences

Allow you to set to show the notification area icon and show system information, warning, or errors here.

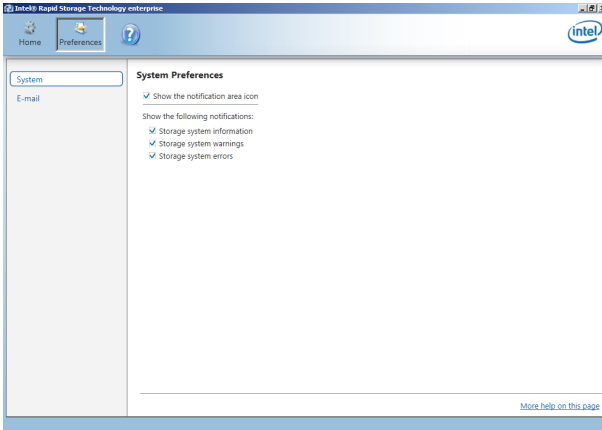

E-Mail Preferences

Allow you to set to sent e-mail of the following events:

- Storage system information
- Storage system warnings
- Storage system errors

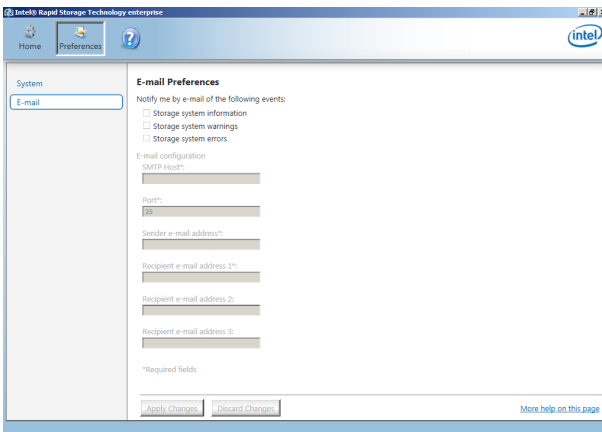

Driver Installation

7

This chapter provides the instructions for installing the necessary drivers for different system components in both Linux[®] and Windows[®] Operating Systems.

7.1 Intel RSTe RAID driver installation

After creating the RAID sets for your server system, you are now ready to install an operating system to the independent hard disk drive or bootable array. This part provides the instructions on how to install the RAID controller drivers during OS installation.

7.1.1 Creating a USB flash drive with RAID driver

When installing Windows® Server OS, you can load the RAID driver from a USB flash drive. You can create a USB flash drive with RAID driver in Windows by copying the files from the support DVD to the USB flash drive.

To copy the RAID driver to a USB flash drive in Windows environment:

1. Place the motherboard support DVD in the optical drive.
2. Connect a USB flash drive to your system.
3. Click on the optical drive to browse the contents of the support DVD.
4. Click **Drivers > C620 INTEL RAID > Windows > Driver** and then copy the RAID driver folder to the USB flash drive.

7.1.2 Installing the RAID controller driver

During Windows® Server 2016 OS installation

To install the RAID controller driver when installing Windows® Server 2016 OS:

1. Boot the computer using the Windows® Server 2016 OS installation disc. Follow the screen instructions to start installing Windows Server 2016.
2. When prompted to choose a type of installation, click **Custom: Install Windows only (advanced)**.

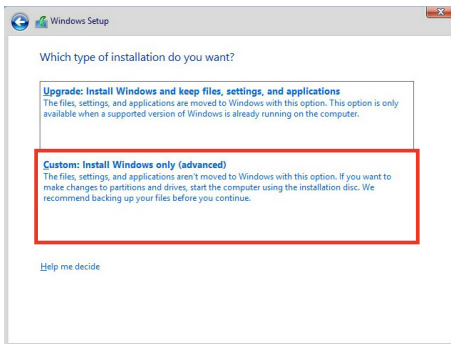

3. Click **Load Driver**.

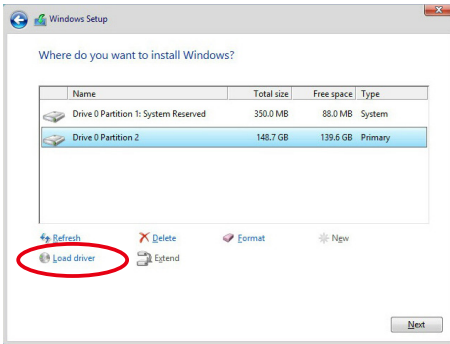

4. A message appears, reminding you to insert the installation media containing the driver of the RAID controller driver. If you have only one optical drive installed in your system, eject the Windows OS installation disc and replace with the motherboard Support DVD into the optical drive. Click **Browse** to continue.



5. Locate the driver in the corresponding folder of the Support DVD then click **OK** to continue.
6. Select the RAID controller driver you need from the list and click **Next**.

- When the system finishes loading the RAID driver, replace the motherboard Support DVD with the Windows Server installation disc. Select the drive to install Windows and click **Next**.

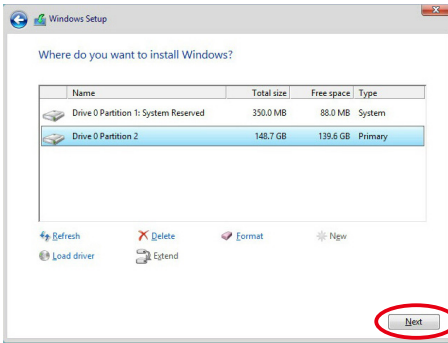

- Setup then proceeds with the OS installation. Follow screen instructions to continue.

7.2 Management applications and utilities installation

The support DVD that is bundled with your motherboard contains drivers, management applications, and utilities that you can install to maximize the features of your motherboard.



The contents of the support DVD are subject to change at any time without notice. Visit the ASUS website (www.asus.com) for the latest updates on software and utilities.

7.3 Running the Support DVD

When you place the support DVD into the optical drive, the DVD automatically displays the main screen if Autorun is enabled in your computer. By default, the Drivers tab is displayed.



If Autorun is NOT enabled in your computer, browse the contents of the support DVD to locate the file **ASSETUP.EXE** from the **BIN** folder. Double-click the **ASSETUP.EXE** to run the support DVD.

The main screen of the Support DVD contains the following tabs:

1. Drivers
2. Utilities
3. Manual
4. Contact

7.3.1 Drivers menu tab

The Drivers Menu shows the available device drivers if the system detects installed devices. Install the necessary drivers to activate the devices.



7.3.2 Utilities menu tab

The Utilities menu displays the software applications and utilities that the motherboard supports.



7.3.3 Manual menu

The Manual menu provides a list of supplementary user guides.



You need an internet browser installed in your OS to view the User Guide.



7.3.4 Contact information menu

The Contact menu displays the ASUS contact information, e-mail addresses, and useful links if you need more information or technical support for your motherboard.



7.4 Intel® chipset device software installation

This section provides the instructions on how to install the Intel® chipset device software on the system.

You need to manually install the Intel® chipset device software on a Windows operating system.

To install the Intel® chipset device software:

1. Restart the computer, and then log on with **Administrator** privileges.
2. Insert the motherboard/system support DVD into the optical drive. The support DVD automatically displays the **Drivers** menu if Autorun is enabled in your computer.



If Autorun is NOT enabled in your computer, browse the contents of the support DVD to locate the file **ASSETUP.EXE** from the **BIN** folder. Double-click the **ASSETUP.EXE** to run the support DVD.

3. Click the item **Intel® Chipset Device Software** from the menu.

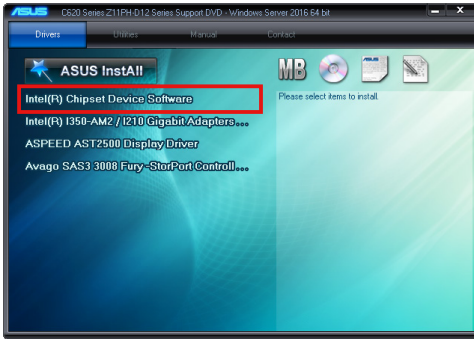

4. The **Intel® Chipset Device Software** window appears. Click **Next** to start the installation.



5. Read the **License Agreement** and click **Accept** to continue the process.

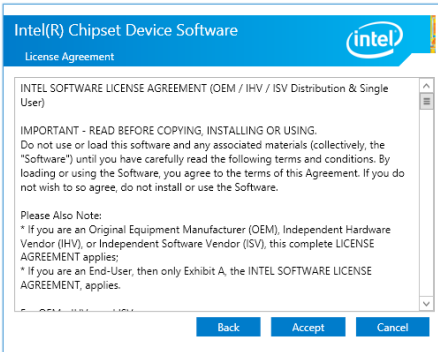

6. Read the **Readme File Information** and click **Install** to start the installation process.

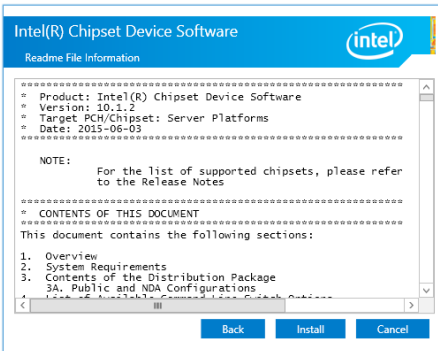

7. Click **Restart Now** to complete the setup process.

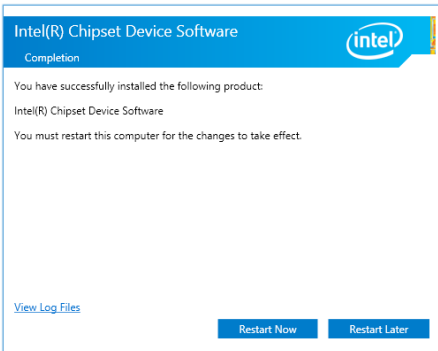

7.5 Installing the Intel® I350-AM2/I210 Gigabit Adapters driver

This section provides the instructions on how to install the **Intel® I350-AM2/I210 Gigabits Adapter Driver** on the system.

To install the **Intel® I350-AM2/I210 Gigabit Adapters Driver** on the Windows® operating system:

1. Restart the computer.
2. Log on with **Administrator** privileges.
3. Insert the motherboard/system support DVD to the optical drive.



If Autorun is NOT enabled in your computer, browse the contents of the support DVD to locate the file **ASSETUP.EXE** from the **BIN** folder. Double-click the **ASSETUP.EXE** to run the support DVD.

4. Click **Intel® I350-AM2/I210 Gigabit Adapters Driver** in the **Drivers** menu of the main screen to start the installation.

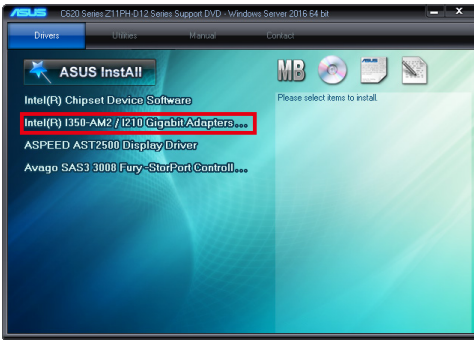

5. Click **Install Drivers and Software** option to begin installation.

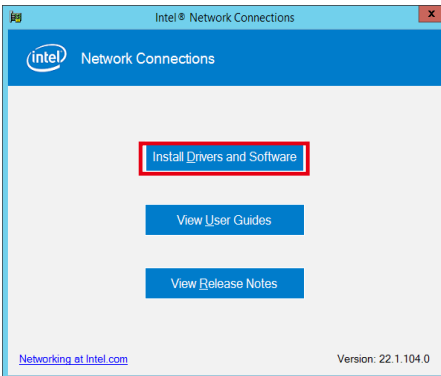

- Click **Next** when the **Intel(R) Network Connections Install Wizard** window appears.

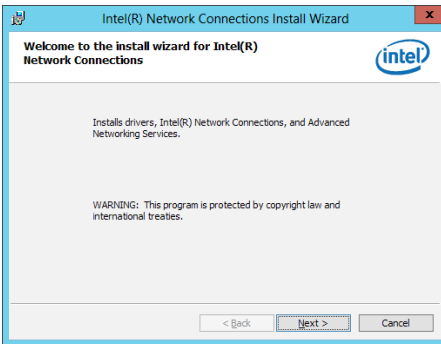

- Tick **I accept the terms in the license agreement** and click **Next** to continue.

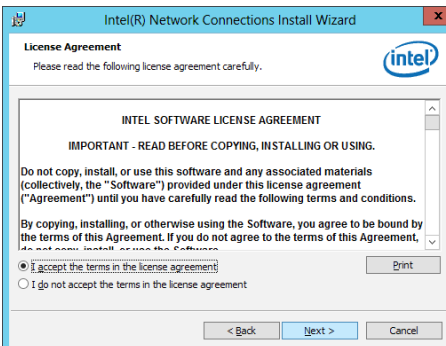

- From the **Setup Options** window, click **Next** to start the installation.



By default, **Intel(R) PROSet for Windows Device Manager** and **Windows PowerShell Module** are ticked.

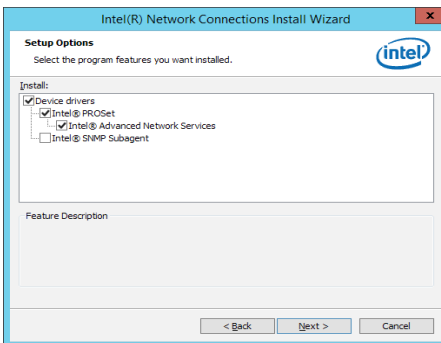

9. Click **Install** to start the installation.

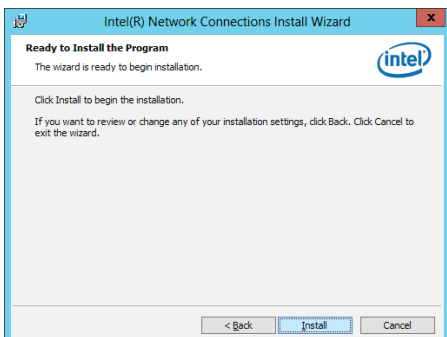

10. When the installation is done, press **Finish** to complete the installation.

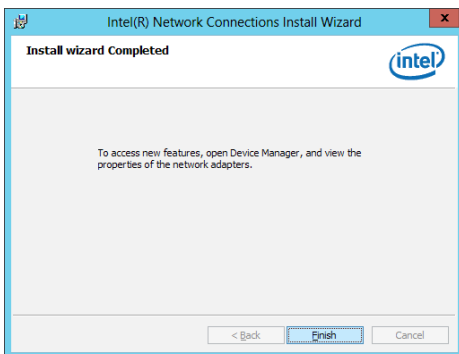

7.6 VGA driver installation

This section provides the instructions on how to install the ASPEED Video Graphics Adapter (VGA) driver.

You need to manually install the ASPEED VGA driver on a Windows® operating system.

To install the ASPEED VGA driver:

1. Restart the computer, and then log on with **Administrator** privileges.
2. Insert the motherboard/system support DVD into the optical drive. The support DVD automatically displays the **Drivers** menu if Autorun is enabled in your computer.



If Autorun is **NOT** enabled in your computer, browse the contents of the support DVD to locate the file **ASSETUP.EXE** from the **BIN** folder. Double-click the **ASSETUP.EXE** to run the support DVD.

3. Click the **ASPEED AST2500 Display Driver** to begin installation.

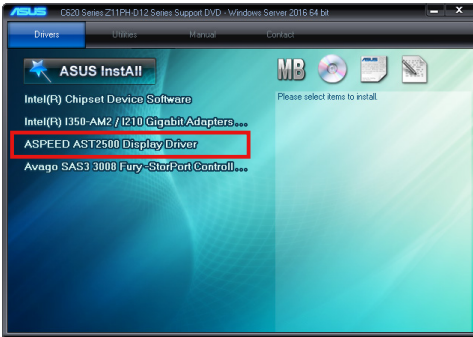

4. From the installation window, click **Next** to start the installation.



5. Click **Install** to start the installation process.

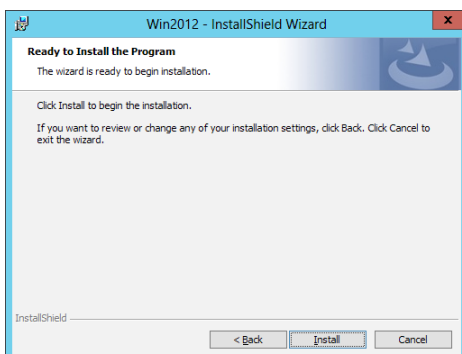

6. Click **Finish** to complete the installation.

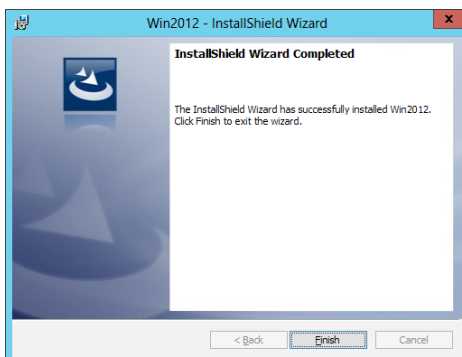

7.7 Intel® Rapid Storage Technology enterprise 5.0 installation

This section provides the instructions on how to install the Intel® Rapid Storage Technology enterprise 5.0 on the system.

You need to manually install the Intel® Rapid Storage Technology enterprise 5.0 utility on a Windows® operating system.

To install the Intel® Rapid Storage Technology enterprise 5.0 utility:

1. Restart the computer, and then log on with **Administrator** privileges.
2. Insert the motherboard/system support DVD into the optical drive, and navigate to the **Utilities** menu.
3. Click the **Intel® Rapid Storage Technology enterprise** to begin installation.



4. The **Intel® Rapid Storage Technology enterprise** window appears. Click **Next** to start the installation.

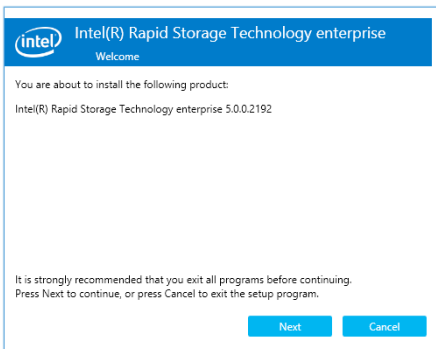

5. Read the **Warning** message and click **Next** to continue.

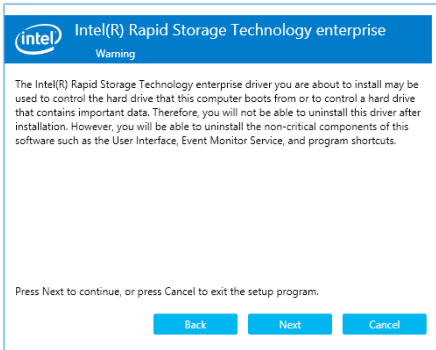

6. Read the **License Agreement** and click **Accept** to continue the process.

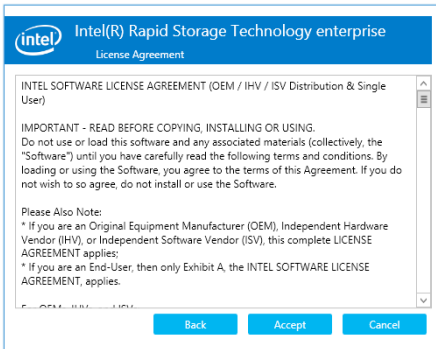

7. Select the destination folder and click **Next** to continue.

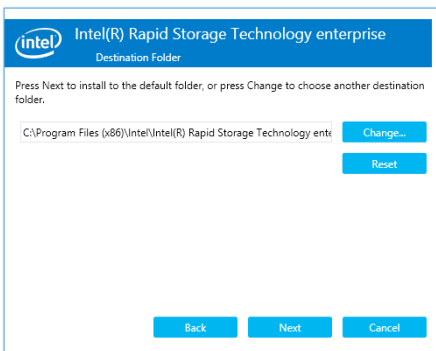

8. Tick the features that you would like to install and click **Next** to continue.

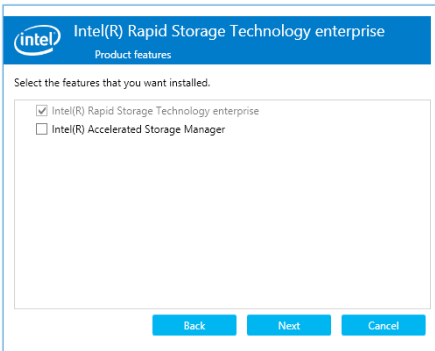

9. Click **Install** to start the installation process.

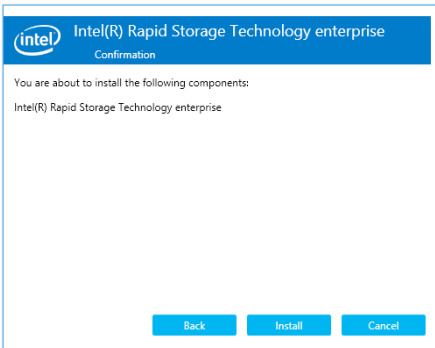

10. Click **Restart Now** to complete the setup process.

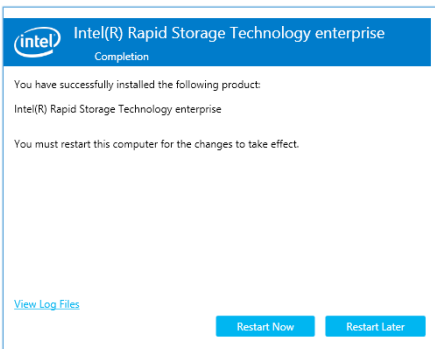

Appendix

Z11PH-D12 block diagram

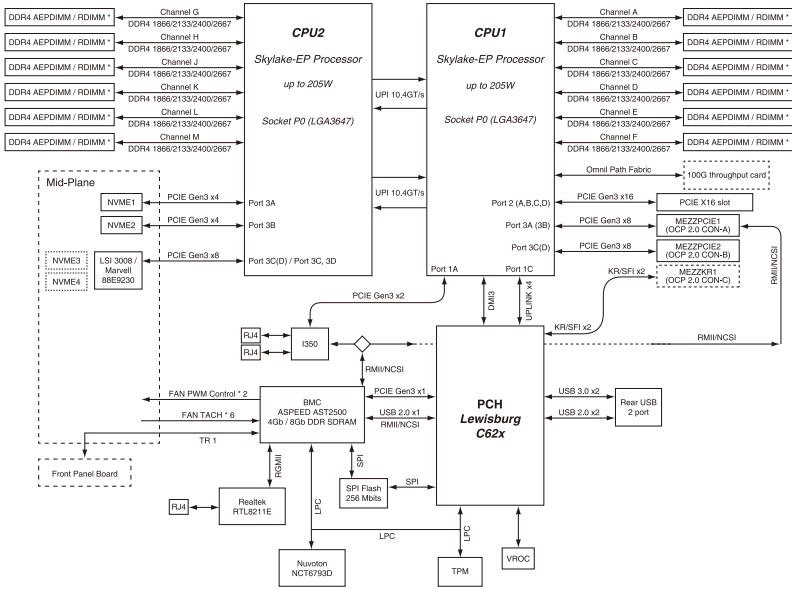

ASUS contact information

ASUSTeK COMPUTER INC.

Address 4F, No. 150, Li-Te Rd., Peitou, Taipei 112, Taiwan
Telephone +886-2-2894-3447
Fax +886-2-2890-7798
Web site <https://www.asus.com>

Technical Support

Telephone +86-21-38429911
Fax +86-21-58668722 ext: 9101
Online Support <https://www.asus.com/support/Product/ContactUs/Services/questionform/?lang=en>

ASUSTeK COMPUTER INC. (Taiwan)

Address 4F, No. 150, Li-Te Rd., Peitou, Taipei 112, Taiwan
Telephone +886-2-2894-3447
Fax +886-2-2890-7798
Web site <https://www.asus.com/tw/>

Technical Support

Telephone +886-2-2894-3447 (0800-093-456)
Online Support <https://www.asus.com/support/Product/ContactUs/Services/questionform/?lang=zh-tw>

ASUSTeK COMPUTER INC. (China)

Address No. 5077, Jindu Road, Minhang District, Shanghai, China
Telephone +86-21-5442-1616
Fax +86-21-5442-0099
Web site <https://www.asus.com.cn>

Technical Support

Telephone +86-20-2804-7506 (400-620-6655)
Online Support <https://www.asus.com/support/Product/ContactUs/Services/questionform/?lang=zh-cn>

ASUS contact information

ASUS COMPUTER INTERNATIONAL (America)

Address 48720 Kato Rd., Fremont, CA 94538, USA
Fax +1-510-608-4555
Web site <https://www.asus.com/us/>

Technical Support

Support fax +1-812-284-0883
General support +1-812-282-2787
Online support <https://www.asus.com/support/Product/ContactUs/Services/questionform/?lang=en-us>

ASUS COMPUTER GmbH (Germany and Austria)

Address Harkort Str. 21-23, 40880 Ratingen, Germany
Fax +49-2102-959911
Web site <https://www.asus.com/de/>

Technical Support

Telephone +49-1805-010923
Support Fax +49-2102-959911
Online support <https://www.asus.com/support/Product/ContactUs/Services/questionform/?lang=de-de>

ASUS Czech Service s.r.o. (Europe)

Address Na Rovince 887, 720 00 Ostrava – Hrabová,
Czech Republic
Telephone +420-596766888
Web site <https://www.asus.com/cz/>

Technical Support

Telephone +420-596-766-891
Fax +420-596-766-329
E-mail advance.rma.eu@asus.com
Online Support <https://www.asus.com/support/Product/ContactUs/Services/questionform/?lang=cs-cz>

ASUS contact information

ASUS Holland BV (The Netherlands)

Address Marconistraat 2, 7825GD EMMEN, The Netherlands
Web site <https://www.asus.com/nl/>

Technical Support

Telephone +31-(0)591-5-70292
Fax +31-(0)591-666853
E-mail advance.rma.eu@asus.com
Online Support <https://www.asus.com/support/Product/ContactUs/Services/questionform/?lang=nl-nl>

ASUS Polska Sp. z o.o. (Poland)

Address Ul. Postępu 6, 02-676 Warszawa, Poland
Web site <https://www.asus.com/pl/>

Technical Support

Telephone +48-225718033
Online Support <https://www.asus.com/support/Product/ContactUs/Services/questionform/?lang=pl-pl>

ASK-Service (Russia and CIS)

Address г.Москва, ул. Орджоникидзе, д.10, Россия
Telephone (495) 640-32-75
Web site <https://www.asus.com/ru/>

Technical Support

Telephone 008-800-100-ASUS (008-800-100-2787)
Online Support <https://www.asus.com/support/Product/ContactUs/Services/questionform/?lang=ru-ru>

Free Manuals Download Website

<http://myh66.com>

<http://usermanuals.us>

<http://www.somanuals.com>

<http://www.4manuals.cc>

<http://www.manual-lib.com>

<http://www.404manual.com>

<http://www.luxmanual.com>

<http://aubethermostatmanual.com>

Golf course search by state

<http://golfingnear.com>

Email search by domain

<http://emailbydomain.com>

Auto manuals search

<http://auto.somanuals.com>

TV manuals search

<http://tv.somanuals.com>