



Hot and Cold Bottled Water Cooler

Model # 7LIECH-SC-SSF

USER MANUAL

⚠ WARNING

TO REDUCE THE RISK OF INJURY AND PROPERTY DAMAGE, USER MUST READ THIS MANUAL BEFORE ASSEMBLING, INSTALLING & OPERATING DISPENSER.

SAVE FOR FUTURE USE

SAFETY PRECAUTIONS

⚠ WARNING

To reduce risk of injury and property damage, user must read this entire manual before assembling, installing & operating dispenser.

Failure to execute the instructions in this manual can cause personal injury or property damage.

This product dispenses water at very high temperatures. Failure to use properly can cause personal injury.

When operating this dispenser, always exercise basic safety precautions, including the following:

- Prior to use, this dispenser must be properly assembled and installed in accordance with this manual.
- This dispenser is intended for water dispensing only. Do NOT use other liquids. Do NOT use for other purposes. Never use any other liquid in the dispenser other than known and microbiologically safe bottled water. Warranty is void if used for any other liquids including coffee, tea, juices, beer or wine.
- For indoor use only. Keep water dispenser in a dry place away from direct sunlight. Do NOT use outdoors.
- Install and use only on a hard, flat and level surface.
- Do NOT place dispenser into an enclosed space or cabinet.
- Do NOT operate dispenser in the presence of explosive fumes.
- Position back of dispenser no closer than 4 inches from wall and permit free airflow between wall and dispenser. There must be at least 4 inches clearance on the sides of the dispenser to permit airflow.
- Use only properly grounded outlets.
- Do not use an extension cord with your water dispenser.
- Always grasp plug and pull straight out from outlet. Never unplug by pulling on power cord.
- Do NOT use dispenser if cord becomes frayed or otherwise damaged.
- To protect against electric shock, do NOT immerse cord, plug, or any other part of cooler in water or other liquids.
- Ensure dispenser is unplugged prior to cleaning.
- Never allow children to dispense hot water without proper and direct supervision. Unplug unit to prevent unsupervised use by children.
- Service should be performed only by a certified technician. Please contact us at 855-VIVA-111 for assistance.
- Turn power switch(es) ON after cooler is plugged in and fill with water.

IMPORTANT: Do NOT Return Dispenser To Store.
If you have a question or problem, please contact 855-VIVA-111 for assistance.

SAFETY PRECAUTIONS ---- Electrical Requirements

WARNING

Electrical Shock Hazard

Plug into a grounded 3 prong outlet.
Do not remove ground prong.
Do not use an adapter.
Do not use an extension cord.
Failure to follow these instructions can result in death, fire, or electrical shock.

A 120 volt, 60 Hz., AC only, 15 amp, fused electrical supply is required. A time-delay fuse or circuit breaker is recommended. Do not overload the circuit, provide separate circuit, if required, to serve only this appliance.

This water cooler is equipped with a power supply cord having a 3 prong grounding plug.

To minimize possible shock hazard, the cord must be plugged into a mating, 3 prong, grounding-type outlet, grounded in accordance with local codes and ordinances, a mating outlet is not available, it is the personal responsibility and obligation of the customer to have the properly grounded outlet installed by a qualified electrician.

If codes permit and a separate ground wire is used, it is recommended that a qualified electrician determine that the ground path is adequate.

Do not ground to a gas pipe.

Check with a qualified electrician if you are not sure the water cooler is properly grounded.

Do not have a fuse in the neutral or ground circuit.

GROUNDING INSTRUCTIONS

For a grounded, cord-connected water cooler:

This water cooler must be grounded. In the event of a malfunction or breakdown, grounding will reduce the risk of electrical shock by providing a path of least resistance for electric current. This water cooler is equipped with a cord having an equipment-grounding conductor and a grounding plug. The plug must be plugged into an appropriate outlet that is properly installed and grounded in accordance with all local codes and ordinances.

WARNING

Improper connection of the equipment-grounding conductor can result in a risk of electric shock. Check with a qualified electrician or serviceman if you are in doubt as to whether the appliance is properly grounded.

Do not modify the plug provided with the appliance-if it will not fit the outlet, have a proper outlet installed by a qualified electrician.

“Please make sure that ELECTRICAL OUTLET IS PROPERLY WIRED TO CORRECT SIZED CIRCUIT BREAKER OR FUSE AND PROPERLY GROUNDED. MUST BE WIRED TO HAVE CORRECT POLARITY.

IMPORTANT: Do NOT Return Dispenser To Store.
If you have a question or problem, please contact 855-VIVA-111 for assistance.

TABLE OF CONTENTS

Safety Precautions	2
Safety Precautions-Electrical Requirements.....	3
Key Information for Future Use	4
Specifications	5
Parts & Features	5
Assembly	6
Cleaning prior to initial use	7
Installation	8
Installing the Correct Bottle Receptacle	9
Operation	10
Proper Care & Cleaning	11
Troubleshooting	12
Limited Warranty	13

KEY INFORMATION FOR FUTURE USE



Please register your dispenser immediately at www.electrotemp.com

For future support please record your serial number (located on label on back of dispenser) and date purchased. Staple your receipt to manual.

You will need this information to obtain warranty service.

Product **Hot and Cold Bottled Water Cooler**

Model Number **7LIECH-SSF**

Serial ID Number _____

Date of Purchase _____

IMPORTANT: Do NOT Return Dispenser To Store.
If you have a question or problem, please contact 855-VIVA-111 for assistance.

SPECIFICATIONS



Power Supply	4.5 AMP
Refrigerant Type	R-134A
Cold Water Power	100 Watts
Cold Capacity / Peak Hour	1.0 Gallon / 3.79 L
Cold Temp Range	3°C – 10°C / 37.4°F - 50°F
Hot Water Power	425 Watts
Hot Capacity / Peak Hour	1.0 Gallon / 3.79 L
Hot Temp Range	80°C – 92°C / 176°F - 197.6°F
Dimensions	91.3 H x 27.5 W x 28.6 D (cm) 35.4 H x 10.8 W x 11.3 D (inch)
Net Weight	27.9lbs/12.7Kg

PARTS & FEATURES

- Bottle Probe (1)
- Hot Water Control (2)
- Child Safety Latch (3)
- Cold Water Control (4)
- Hot Water Tap (5)
- Cold Water Tap (6)
- Drip Tray (7)
- Energy Saving Switch (8)
- Cooling Thermostat (9)
- Carry Handle (10)
- Power Cord (11)
- Drain Plug (12)
- LED night light (13)

Wall Mount Strap and Collar for plain capped bottles (Not Shown)

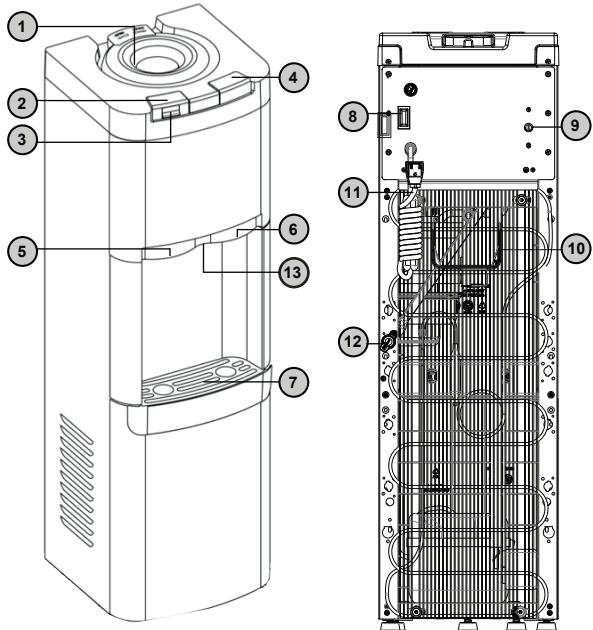

IMPORTANT: Do NOT Return Dispenser To Store.
If you have a question or problem, please contact 855-VIVA-111 for assistance.

ASSEMBLY

⚠ WARNING

To prevent accidental tip hazard, base supplied must be securely fixed to the dispenser as shown.

Do NOT operate dispenser without base properly installed.

Keep plastic bags away from children.

1. Remove dispenser from packaging.
2. Lay dispenser on its back.
3. Position cooler upright. Unpack drip tray and insert into dispenser.
4. Properly dispose all of packaging.

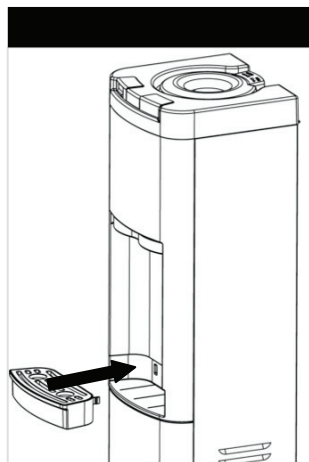

IMPORTANT: Do NOT Return Dispenser To Store.
If you have a question or problem, please contact 855-VIVA-111 for assistance.

CLEANING PRIOR TO INITIAL USE

To remove any odors or dust that may collect during shipment, you must clean dispenser prior to first use.

DO NOT PLUG THE COOLER INTO AN ELECTRICAL POWER OUTLET

Time Required: 40 minutes.

1. Remove bottle receptacle by turning it counter clockwise and pulling up. Store in a safe place.
2. Remove plastic baffle from inside reservoir. Clean with warm soapy water, rinse, then store in a safe place.
3. Fill reservoir with a mixture of 1 gallon tap water and 2 tablespoons of unscented household bleach.
4. Let sit for 30 minutes.

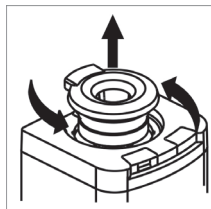

5. Dispense 1 cup of mixture through both faucets to clean out water ways.
6. Place a 2 gallon or larger bucket under the drain plug in the rear of the dispenser. Remove drain cap and silicon plug.

Reminder – Place drain cap and silicon plug in a safe location so they are not lost.

7. Once unit has completed draining, empty the bucket then return it to under the drain cap.
8. Replace drain cap and silicone plug.
9. Wipe inside of reservoir with a soft cloth.
10. Fill the reservoir with 1 gallon of tap water.
11. Dispense 1 cup of water through both faucets to rinse out water ways.

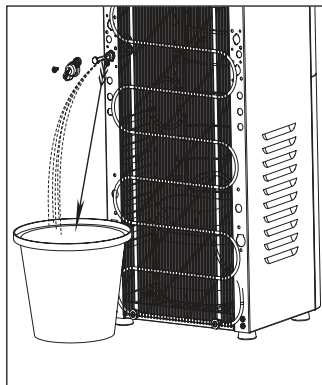

12. Remove drain cap and silicon plug.

Reminder – Place drain cap and silicon plug in a safe location so they are not lost.

13. Remove remaining water from reservoirs by dispensing from both taps into a pitcher.
14. Replace all parts.

Reminder - Don't forget the silicon plug and drain cap.

15. Complete the installation and operation instructions within this manual. If your water has an off taste. Do not return to store. Call 855-VIVA-111 for assistance.

IMPORTANT: Do NOT Return Dispenser To Store.
If you have a question or problem, please contact 855-VIVA-111 for assistance.

INSTALLATION

⚠ CAUTION

To prevent accidental tip hazard, dispenser must be securely anchored to wall as shown.

1. Place dispenser upright.
2. Locate dispenser on a hard and level surface in a cool shaded location near a grounded wall outlet.

Notice: Do NOT plug in power cord yet.

3. Position dispenser so the back is at least 4 inches from wall and there are at least 4 inches of clearance on both sides.
4. Install Wall Mount Strap to prevent accidental tip over:

- Unclip strap from back of dispenser.
- Mount strap 25 inches up from floor directly to wall stud with screw (See illustration A)

If stud is not available, insert and turn anchor directly into sheet rock using a Phillips screwdriver (DO NOT drill hole into sheet rock first when using this anchor). Secure strap by installing screw through washer, then eyelet in strap and into wall mounted anchor. (See illustration B)

- Position cooler in place.
- Clip strap onto back of cooler to right or left side. (See illustration C).
- Adjust length of strap so the dispenser can NOT move forward.

Note – Dispenser can be positioned in a corner but still requires Wall Mount Strap to be installed. Lengthen strap so that once installed the dispenser cannot move forward.

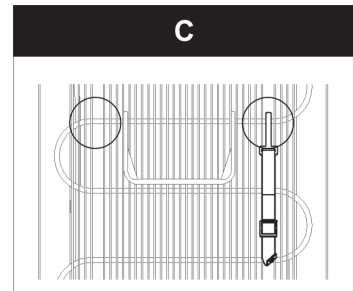
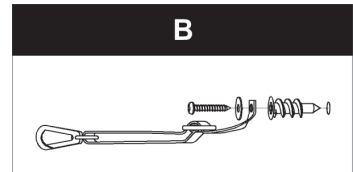
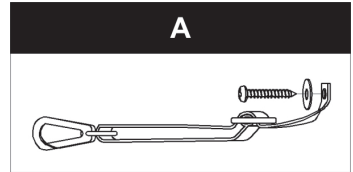

IMPORTANT: Do NOT Return Dispenser To Store.
If you have a question or problem, please contact 855-VIVA-111 for assistance.

INSTALLING THE CORRECT BOTTLE RECEPTACLE

**If Your Water
Bottle Looks Like**

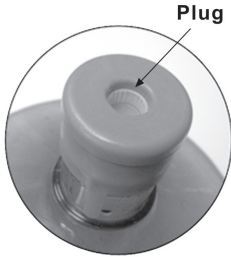

**Then Use This
Bottle Receptacle**

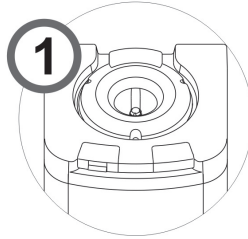

This model comes set up with a Probe Receptacle (1). No changes are required. The Probe will push the Plug out of the way when you place the bottle into the receptacle.

**If Your Water
Bottle Looks Like**

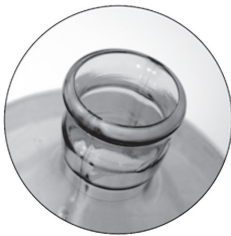

**Then Use This
Bottle Receptacle**

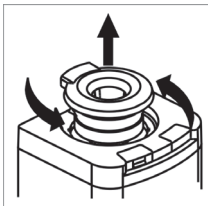
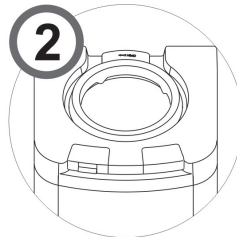

1. Remove bottle receptacle (1) by turning it counter clockwise and pulling up.
2. Remove Collar (2) from foam packaging or bag at front of dispenser.
3. Align tabs.
4. Turn clockwise to secure.

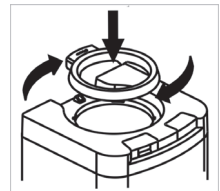

IMPORTANT: Do NOT Return Dispenser To Store.

If you have a question or problem, please contact 855-VIVA-111 for assistance.

OPERATION

⚠ CAUTION

This unit is intended for water dispensing only. Do NOT use other liquids. Do NOT use for other purposes. Warranty is void if used for any other liquids including coffee, tea, juices, beer or wine.

This dispenser has been designed to use water bottles with 3 & 5 gallon capacity. Do NOT use alternative bottles.

Initial Set Up

Notice: To prevent damage to compressor, allow unit to sit upright for at least 4 hours prior to operating.

1. Remove tamper seal from bottle cap. Do NOT remove plastic cap.
2. Clean bottle cap and neck with a soft cloth and warm soapy water, then rinse.
3. Lift bottle and insert onto the probe. Apply slight pressure until the plug inside the cap pushes in and the bottle is seated. Water will begin to flow into the reservoirs causing air bubbles to form in the bottle.
4. Plug cord into a properly grounded wall outlet.
5. Turn energy saving switch on back of dispenser to ON. This switch controls the heating of water. If you do not want hot water, turn this switch OFF.

Initial Rinsing of Water Lines

This unit has been tested and sanitized prior to packing and shipping. During transit dust and odors can accumulate in the tank and lines. You must dispense and dispose at least one quart of water prior to drinking any water.

Dispense Cold Water

Note: After setup, it will take 1 hour to get water to maximum cold temperature. During this time the compressor will run continuously. This is normal.

1. Position bottle, glass, pitcher or cooking pot securely below cold water tap.
 - The circular shapes in the drip plate help align the flow of water. This unit dispenses water at a fast rate. To avoid splashes, hold cup as close to the tap as possible.
2. Depress cold water control downward to start flow.
3. Release cold water control once desired fill level is achieved.

IMPORTANT: Do NOT Return Dispenser To Store.

If you have a question or problem, please contact 855-VIVA-111 for assistance.

PROPER CARE & CLEANING

General Cleaning

Perform: As needed

Time Required: 5 minutes.

Note: Do NOT use abrasive materials or chemical cleaners.

1. Clean cabinet surfaces with a soft cloth and warm soapy water, then rinse.
2. Wipe dust from back of dispenser to improve efficiency.
3. Remove drip tray assembly by pulling it forward. Remove cover. Place tray and cover in dishwasher or wipe parts clean with a soft cloth and warm soapy water.

Cleaning Cold Reservoir and Water Lines

Perform: Every 3 months or whenever an off-taste occurs.

Time Required: 15 minutes.

Note: Best to do prior to loading a fresh bottle.

1. Turn energy saving switch OFF.
2. Unplug power cord from wall outlet.
3. Remove water bottle.
4. Unclip Wall Mount Strap from back of dispenser and turn dispenser around so backside is facing away from the wall.
5. Place a 2 gallon or larger bucket under the drain plug in the rear of the dispenser.

CAUTION

Remove drain cap and silicon plug. Cold water will immediately flow into the bucket. This will be followed several seconds later by hot water at temperatures that can cause severe burns. Avoid direct contact with hot water. Keep children and pets away while draining unit.

Reminder - Place drain cap and silicon plug in a safe location so they are not lost.

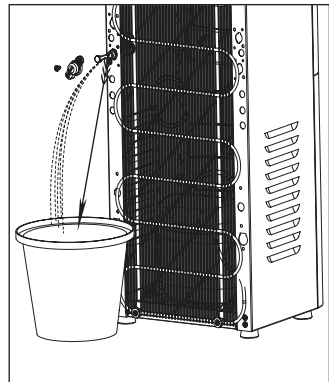

IMPORTANT: Do NOT Return Dispenser To Store.

If you have a question or problem, please contact 855-VIVA-111 for assistance.

TROUBLESHOOTING

Dispenser does not operate.

- Make sure the power cord is properly connected to a working outlet.

Water is leaking.

- Call 855-VIVA-111 for assistance.

Push buttons are stuck and/or faucets are leaking.

- Apply mineral oil (baby oil) to button slides to reduce friction.

No water is coming from the taps.

- Make sure the bottle is not empty. If so replace it.
- Make sure to push the water controls in fully.
- Remove bottle receptacle as per page 6 step 1. Shake bottle receptacle vigorously for a few seconds then replace.

Cold water is not cold.

- It takes up to one hour after setup to dispense cold water.
- Make sure the back of the dispenser is at least 4 inches from a wall and there is free airflow on all 4 sides of the dispenser.
- Make sure tank is not overfilled. Dispense water until bubbles appear in bottle.
- Adjust thermostat by turning clockwise. Adjust in a single increment of 30 degrees of a circle (the equivalent of 1 hour on a standard analog clock face). Wait 1 hour for results. If unsatisfactory, adjust another 30 degrees clockwise, wait, then assess results. Thermostat is located at back of unit.

Hot water is not hot.

- It takes 15-20 minutes after setup to dispense hot water.
- Make sure the power cord is properly connected to a working outlet.
- Make sure energy saving switch is ON.

Dispenser is noisy.

- Make sure dispenser is positioned on a level surface.

Water tastes bad.

- Drain water from reservoirs and replace bottle with a fresh one.
- Clean dispenser per Proper Care & Cleaning instructions.

IMPORTANT: Do NOT Return Dispenser To Store.
If you have a question or problem, please contact 855-VIVA-111 for assistance.

LIMITED WARRANTY

Electrotemp Technologies Inc., (“Vendor”) warrants to the original purchaser of this dispenser, and to no other person, that if this dispenser is assembled and operated in accordance with the printed instructions accompanying it, then for a period of one (1) year from the date of purchase, all parts in such dispenser shall be free from defects in material and workmanship. Vendor may require reasonable proof of your date of purchase from an authorized retailer or distributor. Therefore, you should retain your sales slip or invoice. The Limited Warranty shall be limited to repair or replacement of parts, which prove defective under normal use and service and which Vendor shall determine in its reasonable discretion upon examination to be defective. Before returning any parts, you should contact Vendor’s Customer Service Department using the contact information listed below. If Vendor confirms, after examination, a defect covered by this Limited Warranty in any returned part, and if Vendor approves claim, Vendor will replace such defective part without charge. If you return defective parts, transportation charges must be prepaid by you. Vendor will return replacement parts to original purchaser, freight or postage prepaid.

The Limited Warranty does not cover any failures or operating difficulties due to accident, abuse, misuse, alteration, misapplication, improper installation or improper maintenance or service by you or any third party, or failure to perform normal and routine maintenance on the dispenser, as set out in the User’s Manual. In addition, the Limited Warranty does not cover damages to the finish, such as scratches, dents, discoloration or rust after purchase.

The Limited Warranty is in lieu of all other express warranties. Vendor disclaims all warranties for products that are purchased from seller other than authorized retailers or distributors. AFTER THE PERIOD OF THE ONE (1) YEAR EXPRESS WARRANTY, VENDOR DISCLAIMS ANY AND ALL IMPLIED WARRANTIES, INCLUDING WITHOUT LIMITATION THE IMPLIED WARRANTIES OF MERCHANTABILITY AND FITNESS FOR A PARTICULAR PURPOSE. FURTHER, VENDOR SHALL HAVE NO LIABILITY WHATSOEVER TO PURCHASER OR ANY THIRD PARTY FOR ANY SPECIAL, INDIRECT, PUNITIVE, INCIDENTAL, OR CONSEQUENTIAL DAMAGES. Vendor assumes no responsibility for any defects caused by third parties. This Limited Warranty gives the purchaser specific legal rights; a purchaser may have other rights depending upon where he or she lives. Some jurisdictions do not allow exclusion or limitation of special, incidental or consequential damages, or limitations on how long a warranty lasts, so the above exclusion and limitations may not apply to you.

Warranty is void if electrical outlet is improperly wired to incorrectly sized circuit breaker or fuse, if not grounded properly, or wires do not have correct polarity.

Electrotemp Technologies Inc.
406 Watline Avenue
Mississauga, Ontario, Canada, L4Z-1X2
888-828-1426
www.electrotemp.com

IMPORTANT: Do NOT Return Dispenser To Store.
If you have a question or problem, please contact 855-VIVA-111 for assistance.

修 订	版本号	修订内容	修订人	修订日期
	A	对应铭牌，重量由13.1Kg更改为12.7Kg	罗亚男	2012-11-10

名称: 7LIECH-SC-SSFManual (VIVA) -English

图号: 5M008973X1

技术要求:

- 1、尺寸: 143×210mm
- 2、单色印刷
- 3、产品符合Rosh要求
- 4、批量生产前一定要样品确认，
不得擅自更改图纸。

设计:

审核:

批准:

Free Manuals Download Website

<http://myh66.com>

<http://usermanuals.us>

<http://www.somanuals.com>

<http://www.4manuals.cc>

<http://www.manual-lib.com>

<http://www.404manual.com>

<http://www.luxmanual.com>

<http://aubethermostatmanual.com>

Golf course search by state

<http://golfingnear.com>

Email search by domain

<http://emailbydomain.com>

Auto manuals search

<http://auto.somanuals.com>

TV manuals search

<http://tv.somanuals.com>