

▶ HKB64540NB  
HKB64NB540

EN User Manual  
Hob

# USER MANUAL



**AEG**

## CONTENTS

1. SAFETY INFORMATION.....	2
2. SAFETY INSTRUCTIONS.....	5
3. INSTALLATION.....	7
4. PRODUCT DESCRIPTION.....	13
5. DAILY USE.....	14
6. HINTS AND TIPS.....	16
7. CARE AND CLEANING.....	18
8. TROUBLESHOOTING.....	19
9. TECHNICAL DATA.....	21
10. ENERGY EFFICIENCY.....	23

## FOR PERFECT RESULTS

Thank you for choosing this AEG product. We have created it to give you impeccable performance for many years, with innovative technologies that help make life simpler features you might not find on ordinary appliances. Please spend a few minutes reading to get the very best from it.

Visit our website for:



Get usage advice, brochures, trouble shooter, service information:  
**[www.aeg.com/webselfservice](http://www.aeg.com/webselfservice)**



Register your product for better service:  
**[www.registeraeg.com](http://www.registeraeg.com)**



Buy Accessories, Consumables and Original spare parts for your appliance:  
**[www.aeg.com/shop](http://www.aeg.com/shop)**

## CUSTOMER CARE AND SERVICE

Always use original spare parts.

When contacting our Authorised Service Centre, ensure that you have the following data available: Model, PNC, Serial Number.

The information can be found on the rating plate.

 Warning / Caution-Safety information

 General information and tips

 Environmental information

Subject to change without notice.

### 1. SAFETY INFORMATION

Before the installation and use of the appliance, carefully read the supplied instructions. The manufacturer is not responsible for any injuries or damages that are the result of incorrect installation or

usage. Always keep the instructions in a safe and accessible location for future reference.

## 1.1 Children and vulnerable people safety

- This appliance can be used by children aged from 8 years and above and persons with reduced physical, sensory or mental capabilities or lack of experience and knowledge if they have been given supervision or instruction concerning the use of the appliance in a safe way and understand the hazards involved.
- Children between 3 and 8 years of age and persons with very extensive and complex disabilities shall be kept away unless continuously supervised.
- Children of less than 3 years of age should be kept away unless continuously supervised.
- Do not let children play with the appliance.
- Keep all packaging away from children and dispose of it appropriately.
- Keep children and pets away from the appliance when it operates or when it cools down. Accessible parts are hot.
- If the appliance has a child safety device, it should be activated.
- Children shall not carry out cleaning and user maintenance of the appliance without supervision.



## 1.2 General Safety

- **WARNING:** The appliance and its accessible parts become hot during use. Care should be taken to avoid touching heating elements.
- Do not operate the appliance by means of an external timer or separate remote-control system.
- **WARNING:** Unattended cooking on a hob with fat or oil can be dangerous and may result in fire.
- **NEVER** try to extinguish a fire with water, but switch off the appliance and then cover flame e.g. with a lid or a fire blanket.

- CAUTION: The cooking process has to be supervised. A short term cooking process has to be supervised continuously.
- WARNING: Danger of fire: Do not store items on the cooking surfaces.
- Metallic objects such as knives, forks, spoons and lids should not be placed on the hob surface since they can get hot.
- Do not use a steam cleaner to clean the appliance.
- If the glass ceramic surface / glass surface is cracked, switch off the appliance and unplug it from the mains. In case the appliance is connected to the mains directly using junction box, remove the fuse to disconnect the appliance from power supply. In either case contact the Authorised Service Centre.
- In case of hotplate glass breakage:
  - shut immediately off all burners and any electrical heating element and isolate the appliance from the power supply,
  - do not touch the appliance surface,
  - do not use the appliance.
- If the supply cord is damaged, it must be replaced by the manufacturer, an authorized Service or similarly qualified persons in order to avoid a hazard.
- Where the appliance is directly connected to the power supply, an all-pole isolating switch with a contact gap is required. Complete disconnection in compliance with the conditions specified in overvoltage category III must be guaranteed. The earth cable is excluded from this.
- When you route the mains cable, make sure that the cable doesn't come into direct contact (for example using insulating sleeving) with parts that can reach temperatures of more than 50°C above room temperature.
- WARNING: Use only hob guards designed by the manufacturer of the cooking appliance or indicated by the manufacturer of the appliance in the instructions

for use as suitable or hob guards incorporated in the appliance. The use of inappropriate guards can cause accidents.

## 2. SAFETY INSTRUCTIONS

This appliance is suitable for the following markets:   

### 2.1 Installation



#### **WARNING!**

Only a qualified person must install this appliance.



#### **WARNING!**

Risk of injury or damage to the appliance.

- Remove all the packaging.
- Do not install or use a damaged appliance.
- Follow the installation instructions supplied with the appliance.
- Keep the minimum distance from other appliances and units.
- Always take care when moving the appliance as it is heavy. Always use safety gloves and enclosed footwear.
- Seal the cut surfaces with a sealant to prevent moisture to cause swelling.
- Protect the bottom of the appliance from steam and moisture.
- Do not install the appliance adjacent to a door or under a window. This prevents hot cookware falling from the appliance when the door or the window is opened.
- If the appliance is installed above drawers make sure that the space, between the bottom of the appliance and the upper drawer, is sufficient for air circulation.
- The underside of the appliance can get hot when in use. If an oven has not been fitted underneath the hob and underside of the appliance is accessible and could allow a user or items stored beneath the hob to come in direct contact with the underside of the hob, an intermediate protection panel must be fitted.
- Plywood or kitchen carcass material is acceptable for the panel.

- The panel must be removable for servicing. Screws used to fix the panel must be accessible after installation.

### 2.2 Electrical Connection



#### **WARNING!**

Risk of fire and electric shock.

- All electrical connections should be made by a qualified electrician.
- The appliance must be earthed.
- Before carrying out any operation make sure that the appliance is disconnected from the power supply.
- Make sure that the parameters on the rating plate are compatible with the electrical ratings of the mains power supply.
- Make sure the appliance is installed correctly. Loose and incorrect electricity mains cable or plug (if applicable) can make the terminal become too hot.
- Use the correct electricity mains cable.
- Do not let the electricity mains cable tangle.
- Make sure that a shock protection is installed.
- Use the strain relief clamp on the cable.
- Make sure the mains cable or plug (if applicable) does not touch the hot appliance or hot cookware, when you connect the appliance to the near sockets.
- Do not use multi-plug adapters and extension cables.
- Make sure not to cause damage to the mains plug (if applicable) or to the mains cable. Contact our Authorised Service Centre or an electrician to change a damaged mains cable.
- The shock protection of live and insulated parts must be fastened in

such a way that it cannot be removed without tools.

- Connect the mains plug to the mains socket only at the end of the installation. Make sure that there is access to the mains plug after the installation.
- If the mains socket is loose, do not connect the mains plug.
- Do not pull the mains cable to disconnect the appliance. Always pull the mains plug.
- Use only correct isolation devices: line protecting cut-outs, fuses (screw type fuses removed from the holder), earth leakage trips and contactors.
- The electrical installation must have an isolation device which lets you disconnect the appliance from the mains at all poles. The isolation device must have a contact opening width of minimum 3 mm.

## 2.3 Gas connection

- All gas connections should be made by a qualified person.
- Before installation, make sure that the local distribution conditions (nature of the gas and gas pressure) and the adjustment of the appliance are compatible.
- Make sure that there is air circulation around the appliance.
- The information about the gas supply is on the rating plate.
- This appliance is not connected to a device, which evacuates the products of combustion. Make sure to connect the appliance according to current installation regulations. Pay attention to requirements regarding adequate ventilation.

## 2.4 Use



**WARNING!**  
Risk of injury, burns and electric shock.

- Remove all the packaging, labelling and protective film (if applicable) before first use.
- Use this appliance in a household environment.
- Do not change the specification of this appliance.

- Make sure that the ventilation openings are not blocked.
- Do not let the appliance stay unattended during operation.
- Set the cooking zone to "off" after each use.
- Do not put cutlery or saucepan lids on the cooking zones. They can become hot.
- Do not operate the appliance with wet hands or when it has contact with water.
- Do not use the appliance as a work surface or as a storage surface.
- When you place food into hot oil, it may splash.



**WARNING!**  
Risk of fire and explosion

- Fats and oil when heated can release flammable vapours. Keep flames or heated objects away from fats and oils when you cook with them.
- The vapours that very hot oil releases can cause spontaneous combustion.
- Used oil, that can contain food remnants, can cause fire at a lower temperature than oil used for the first time.
- Do not put flammable products or items that are wet with flammable products in, near or on the appliance.



**WARNING!**  
Risk of damage to the appliance.

- Do not keep hot cookware on the control panel.
- Do not let cookware to boil dry.
- Be careful not to let objects or cookware fall on the appliance. The surface can be damaged.
- Do not activate the cooking zones with empty cookware or without cookware.
- Do not put aluminium foil on the appliance.
- Cookware made of cast iron, aluminium or with a damaged bottom can cause scratches on the glass / glass ceramic. Always lift these objects up when you have to move them on the cooking surface.

- Use only stable cookware with the correct shape and diameter larger than the dimensions of the burners.
- Make sure cookware is centrally positioned on the burners.
- Make sure the flame does not go out when you quickly turn the knob from the maximum to the minimum position.
- Use only the accessories supplied with the appliance.
- Do not install a flame diffuser on the burner.
- The use of a gas cooking appliance results in the production of heat and moisture. Provide good ventilation in the room where the appliance is installed.
- Prolonged intensive use of the appliance may call for additional ventilation, for example opening of a window, or more effective ventilation, for example increasing the level of mechanical ventilation where present.
- This appliance is for cooking purposes only. It must not be used for other purposes, for example room heating.
- Do not let acid liquids, for example vinegar, lemon juice or limescale remover, touch the hob. This can cause matt patches.
- Discoloration of the enamel or stainless steel has no effect on the performance of the appliance.
- Clean the appliance regularly to prevent the deterioration of the surface material.
- Deactivate the appliance and let it cool down before you clean it.
- Disconnect the appliance from the electrical supply before maintenance.
- Do not use water spray and steam to clean the appliance.
- Clean the appliance with a moist soft cloth. Only use neutral detergents. Do not use any abrasive products, abrasive cleaning pads, solvents or metal objects.
- Do not clean the burners in the dishwasher.

## 2.6 Service

- To repair the appliance contact an Authorised Service Centre.
- Use original spare parts only.

## 2.7 Disposal



### **WARNING!**

Risk of injury or suffocation.

- Contact your municipal authority for information on how to discard the appliance correctly.
- Disconnect the appliance from the mains supply.
- Cut off the mains electrical cable close to the appliance and dispose of it.
- Flat the external gas pipes.

## 2.5 Care and cleaning



### **WARNING!**

Do not remove the buttons, knobs or gaskets from the control panel. Water may get inside the appliance and cause damage.

# 3. INSTALLATION



### **WARNING!**

Refer to Safety chapters.

## 3.1 Before the installation

Before you install the hob, write down the information below from the rating

plate. The rating plate is on the bottom of the hob.

Model .....  
 PNC .....  
 Serial number .....

## 3.2 Important safety requirements

This hob must be installed in accordance with the Gas Safety (Installation and Use) Regulations (Current Edition) and the IEE Wiring Regulations (Current Edition).

For appliances installed in the Republic of Ireland please refer to NSAI- Domestic Gas Installation I.S. 813 Current Editions and the ETCI Rules for Electrical Installations.

### Provision for ventilation

Detailed recommendations are contained in the following British Standards Codes Of Practice: B.S. 6172/ B.S. 5440, Par. 2 and B.S. 6891 Current Editions.

The hob should not be installed in a bed sitting room with a volume of less than 20 m<sup>3</sup>. If it is installed in a room of volume less than 5 m<sup>3</sup> an air vent of effective area of 100 cm<sup>2</sup> is required. If it is installed in a room of volume between 5 m<sup>3</sup> and 10 m<sup>3</sup> an air vent of effective area of 50 cm<sup>2</sup> is required, while if the volume exceeds 11 m<sup>3</sup> no air vent is required.

However, if the room has a door which opens directly to the outside no air vent is required even if the volume is between 5 m<sup>3</sup> and 11 m<sup>3</sup>.

If there are other fuel burning appliances in the same room, B.S. 5440 Part 2 Current Edition, should be consulted to determine the requisite air vent requirements.

For appliances installed in the Republic of Ireland please refer to the NSAI- Domestic Gas Installation I.S. 813 Current Editions Table Four.

### Location

The hob may be located in a kitchen, a kitchen/diner or bed sitting room (with a volume greater than 20 m<sup>3</sup>), but not in a bathroom or shower room.

The minimum distance combustible material can be fitted above the hob in line with the edges of the hob is 400 mm. If it is fitted below 400 mm a space of 50 mm must be allowed from the edges of the hob.

For appliances installed in the Republic of Ireland please refer to NSAI- Domestic Gas Installation I.S 813 Current Edition Section 7- Permitted Locations of Appliance.

## 3.3 Gas Connection



### WARNING!

Any gas installation must be carried out by a GAS SAFE REGISTER installer.



Please refer to the technical instructions on how to adjust the hob to the gas specifications on Malta.



This appliance is certified for Malta.

Make sure that, once the hob is installed, it is easily accessible for the engineer in the event of a breakdown.

The manufacturer will not accept liability, should the above instructions or any of the other safety instructions incorporated in this instruction booklet be ignored.

On the end of the shaft, which includes the R 1/2" threaded elbow, adjustment is fixed so that the washer is fitted between the components as shown in the diagram. Screw the parts together without using excessive force.

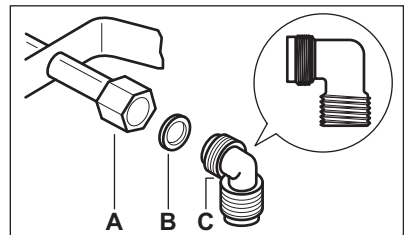

**A.** End of shaft with nut  
**B.** Washer supplied with the appliance  
**C.** Elbow supplied with the appliance  
 Connection to the gas supply should be with either rigid or semi-rigid pipe, i.e. steel or copper.

The connection should be suitable for connecting to R 1/2 (1/2 BSP male thread).



When the final connection has been made, it is essential that a thorough leak test is carried out on the hob and installation.

Make sure that the main connection pipe does not exert any strain on the hob.

If you use flexible metal pipes make sure that they agree to ISO 10380 and ISO 10807 standards. Be careful they do not come in touch with mobile parts or they are not squeezed. Also be careful when the hob is put together with an oven.



#### CAUTION!

It is important to install the elbow correctly, with the shoulder on the end of the thread, fitted to the hob connecting pipe.



#### CAUTION!

Failure to ensure the correct assembly will cause leakage of gas.



#### CAUTION!

Make sure that the gas supply pressure of the appliance obeys the recommended values.

#### Rigid connection:

Carry out connection by using metal rigid pipes (copper with mechanical end).

### 3.4 Injectors replacement

1. Remove the pan supports.
2. Remove the caps and crowns of the burner.
3. With a socket spanner 7 remove the injectors and replace them with the ones which are necessary for the type of gas you use (see table in "Technical Data" chapter).
4. Assemble the parts, follow the same procedure backwards.
5. Replace the rating plate (it is near the gas supply pipe) with the one for the new type of gas supply. You can find this plate in the package supplied with the appliance.

If the supply gas pressure is changeable or different from the necessary pressure, you must fit an applicable pressure adjuster on the gas supply pipe.

### 3.5 Adjustment of minimum level



#### WARNING!

Information for authorised installer only.

To adjust the minimum level of the burners:

1. Light the burner.
2. Turn the knob on the minimum position.
3. Remove the knob and using thin screwdriver lift up and remove the plastic magnet holder.

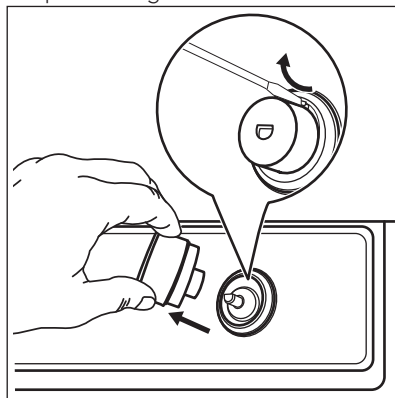

4. With a thin screwdriver, adjust the bypass screw position (A).

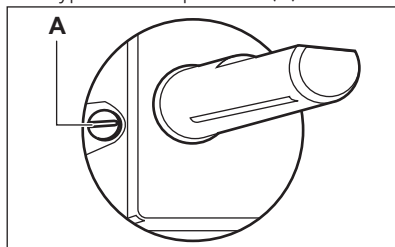

5. If you change:
  - from natural gas G20 20 mbar to liquid gas, fully tighten the bypass screw in.
  - from liquid gas to natural gas G20 20 mbar, undo the bypass screw approximately 1/4 of a turn (1/2 of a turn for Multi Crown burner).
6. Reassemble the magnet holder and the knob.

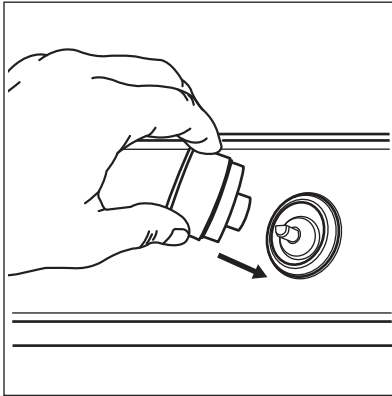
**WARNING!**

Make sure the flame does not go out when you quickly turn the knob from the maximum position to the minimum position.

**3.6 Electrical connection**

- Do not pull the mains cable to disconnect the appliance. Always pull the mains plug (if applicable).
- The appliance must not be connected with an extension cable, an adapter or a multiple socket. There is a risk of fire.
- Do not let the power cable to heat up to a temperature of more than 90° C. The cable should be guided by means of clamps fixed to the side of the cabinet, in order to avoid any contact with the appliance beneath the cooktop.
- Make sure that there is access to the mains plug after the installation.



If the pilot lights turn on after connecting the hob to the mains, turn on and off the control knob and wait until the residual heat indicator goes out.

**Electrical Requirements**

Permanent electrical installation must agree with the latest I.E.E. Regulations and local Electricity Board regulations. For your own safety the installation must be done by a qualified electrician (e.g. your local Electricity Board, or a

contractor who is on the roll of the National Inspection Council for Electrical Installation Contracting [NICEIC]).



**The manufacturer refuses to be held responsible, if these safety measures are not abided by.**

**Supply connections**

This hob has to be connected to 220-240 V (~ 50-60 Hz ) electricity supply.

**The hob has a terminal block which is marked as follows:**

- **L** — Live terminal
- **N** — Neutral terminal
-  or **E** — Earth terminal

Before carrying out the connection, make sure:

1. The limiter valve and the electrical system can take the appliance load (see the rating plate)
2. The supply system is equipped with an efficient earth connection in compliance with the current standards and regulations
3. The outlet or omnipolar switch used for connection is easily accessible with the appliance installed.

The appliance is supplied with a 3 core flexible power cable with a 3 amp plug. If it is necessary to change the fuse, use a 3 amp ASTA-approved (BS 1362) fuse.

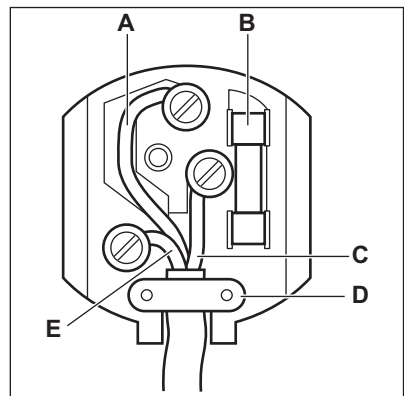

- A.** Green and Yellow
- B.** 3 amp fuse
- C.** Brown
- D.** Cord clamp
- E.** Blue

The wires in the cord are coloured as follows:

Green and yellow	- Earth
Blue	- Neutral
Brown	- Live



### WARNING!

A cut off plug inserted into a 13 amp socket is a serious shock hazard. Ensure that the cut off plug is disposed of safely.

## 3.7 Replacement of the connection cable



The replacement of electric cable must be carried out exclusively by the service force centre or by personnel with similar competencies, in accordance with the current regulations.



To replace the connection cable use only H03V2V2-F T90 or equivalent type. Make sure that the cable section is applicable to the voltage load and the working temperature. The yellow/green earth wire (B) must be approximately 2 cm longer than the live and neutral wire (A).

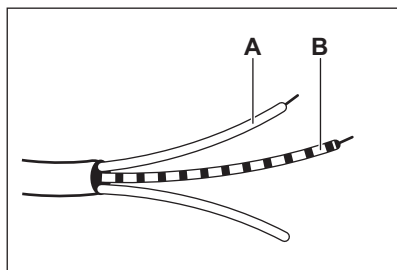

1. Connect the green and yellow (earth) wire to the terminal which is marked with the letter 'E', or the earth

symbol , or coloured green and yellow.

2. Connect the blue (neutral) wire to the terminal which is marked with the letter 'N' or coloured blue.
3. Connect the brown (live) wire to the terminal which is marked with the letter 'L'. It must always be connected to the network phase. There must be no cut or stray strands of wire present. The cord clamp must be correctly attached to the outer sheath.

## 3.8 Assembly

1.

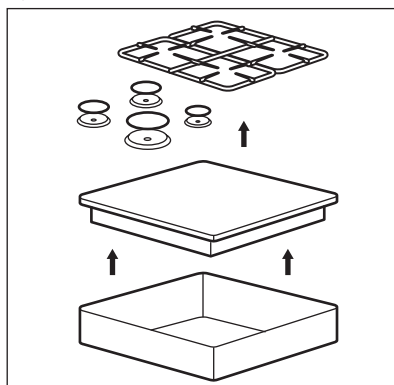

2.

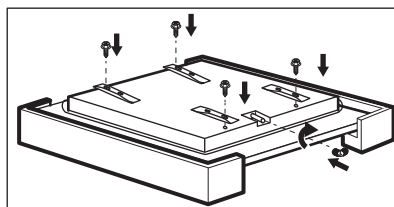

3.

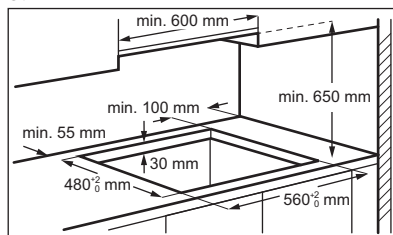

4.

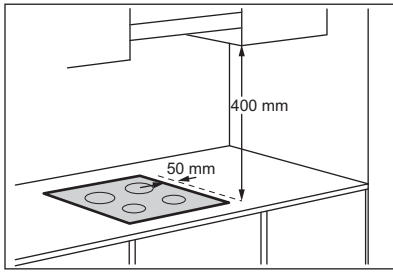

**i** If a furniture unit is installed at a distance of 400 mm above the hob, there must be a minimum safety distance of 50 mm to the left or right from the edge of the hob.

5.

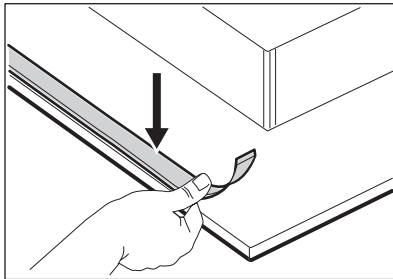

6.

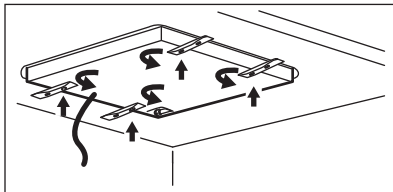

7.

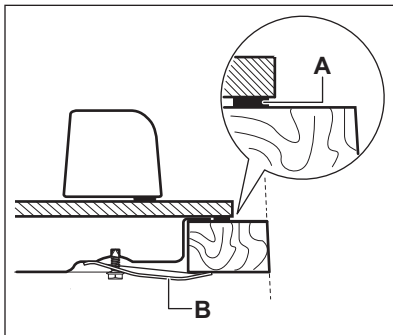

A) supplied seal

8. B) supplied brackets

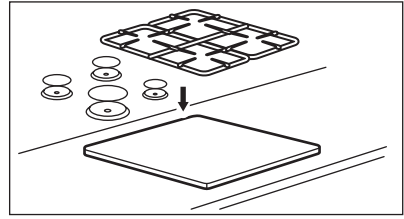

**!** **CAUTION!**  
Install the appliance only on a worktop with flat surface.

### 3.9 Installing hob under the hood

**i** If you install the hob under a hood, please see the installation instructions of the hood for the minimum distance between the appliances.

### 3.10 Possibilities for insertion

The panel installed below the hob must be easy to remove and let an easy access in case a technical assistance intervention is necessary.

#### Kitchen unit with door or drawer

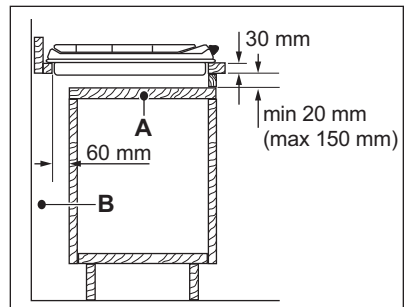

A. Removable panel  
B. Space for connections

#### Kitchen unit with oven

The electrical connection of the hob and the oven must be installed separately for safety reasons and to let easy remove oven from the unit.

## 4. PRODUCT DESCRIPTION

### 4.1 Cooking surface layout

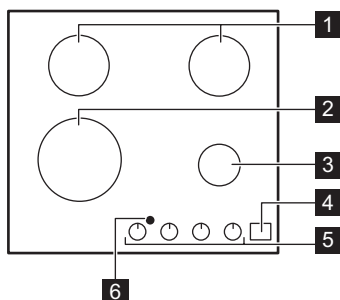



- 1 Semi-rapid burner
- 2 Multi Crown burner
- 3 Auxiliary burner
- 4 Control panel
- 5 Control knobs
- 6 Window for Hob<sup>2</sup>Hood infrared signal

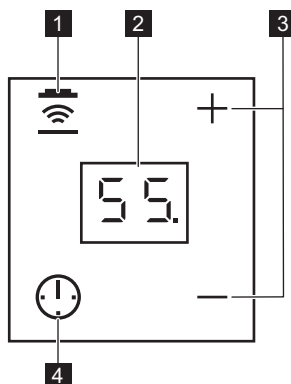

### 4.2 Control panel layout



Use the sensor fields to operate the Minute Minder and Hob<sup>2</sup>Hood. The displays, indicators and sounds tell which functions operate.

	Sensor field	Function	Comment
1		Hob <sup>2</sup> Hood	To activate and deactivate the manual mode of the function.
2	-	Timer display	To show the time in minutes.
3		-	To increase or decrease the time.
4		-	To select the Timer function.

### 4.3 Control knob

Symbol	Description
	no gas supply / off position
	ignition position / maximum gas supply
	minimum gas supply

### 4.4 Residual heat

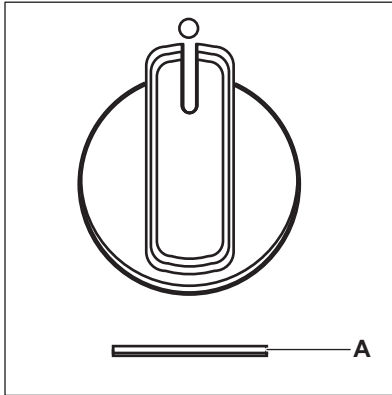

A. Residual heat indicator.



**WARNING!**

There is a risk of burns from residual heat.



The residual heat indicator lights up when you turn off the burner.

Knob of the burner	Time of cooking (min)	
	on < 5	on > 5
Multi Crown	off after 25	off after 25
Semi-rapid	off after 10	off after 20
Auxiliary	off after 5	off after 15

## 5. DAILY USE



**WARNING!**

Refer to Safety chapters.

## 5.1 Burner overview

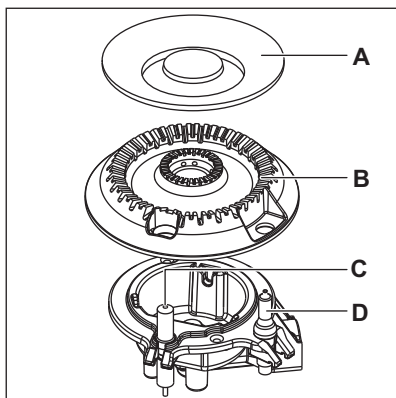
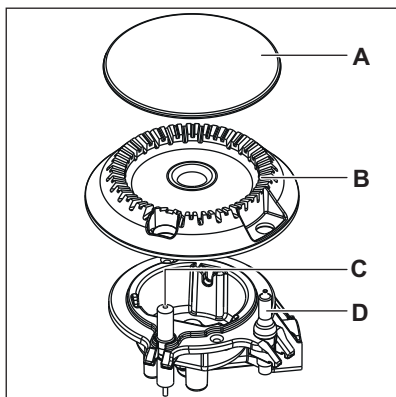

- A. Burner cap
- B. Burner crown
- C. Ignition candle
- D. Thermocouple

## 5.2 Ignition of the burner

- i** Always light the burner before you put on the cookware.



### **WARNING!**

Be very careful when you use open fire in the kitchen environment. The manufacturer declines any responsibility in case of the flame misuse.

1. Push the control knob down and turn it counterclockwise to the maximum gas supply position (Ⓐ).
2. Keep the control knob pushed for equal or less than 10 seconds. This lets the thermocouple warm up. If not, the gas supply is interrupted.
3. Adjust the flame after it is regular.



If after some tries the burner does not light, check if the crown and its cap are in correct positions.



### **WARNING!**

Do not keep the control knob pushed for more than 15 seconds. If the burner does not light after 15 seconds, release the control knob, turn it into off position and try to light the burner again after minimum 1 minute.



### **CAUTION!**

In the absence of electricity you can ignite the burner without electrical device; in this case approach the burner with a flame, turn the control knob counterclockwise to maximum gas supply position and push it down. Keep the control knob pushed for equal or less than 10 seconds to let the thermocouple warm up.



If the burner accidentally goes out, turn the control knob to the off position and try to light the burner again after minimum 1 minute.







The spark generator can start automatically when you switch on the mains, after installation or a power cut. It is normal.





Each control knob has a pilot light. It lights up when you turn the control knob.

 The hob is supplied with the progressive valves. They make the flame regulation more precise.

 **WARNING!**  
If you do not switch the knob to the off position, after two hours a warning sound is emitted and the symbols flash red. It reminds you that the burner is on. To stop the sound, touch , ,  or .



### 5.3 Turning the burner off

To put the flame out, turn the knob to the off position .





 **WARNING!**  
Always turn the flame down or switch it off before you remove the pans from the burner.

### 5.4 Minute Minder

You can use this function as a Minute Minder.

1. Touch .  
To activate the function.
2. Touch  or  of the timer to set the time (00 - 99 minutes).  
When the time comes to an end, the sound operates and **00** flashes.

 In the last minute the time decreases in seconds, and the last 10 seconds the timer emits a sound signal.

3. Touch , ,  or .  
To stop the sound.
4. To stop the timer, touch longer .

 You can use the Minute Minder at any time also if the appliance is off.

 The function has no effect on the operation of the burners.



### 5.5 Hob²Hood

It is an advanced automatic function which connects the hob to a special hood. Both the hob and the hood have an infrared signal communicator. You can also operate the fan from the hob manually.

 For most of the hoods, the remote system is originally deactivated. Activate it before you use the function. For more information refer to the hood user manual.

#### Automatic modes

Mode	Automatic light	Fan speed
H0	Off	Off
HL	On	Off
H1	On	Level 1
H2	On	Level 2
H3	On	Level 3

 Touch longer  to turn off the fan and the light.

 **WARNING!**  
After end of cooking, the hood does not turn off automatically. Turn it off manually.

## 6. HINTS AND TIPS

 **WARNING!**  
Refer to Safety chapters.



## 6.1 Cookware



### CAUTION!

Do not use cast iron pans, clay or earthenware pots, grill or toaster plates.



### WARNING!

Do not put the same pan on two burners.



### WARNING!

Do not put unstable or damaged pots on the burner to prevent spills and injuries.



### CAUTION!

Make sure that the bottoms of pots do not stand too close to the control knob, otherwise the flame heats the control knob up.



### CAUTION!

Make sure that pot handles are not above the front edge of the cooktop.



### CAUTION!

Make sure that the pots are placed centrally on the burner in order to get the maximum stability and a lower gas consumption.



### CAUTION!

Liquids spilt during cooking can cause the glass to break.

## 6.2 Diameters of cookware



Use cookware with diameters applicable to the size of burners.

Burner	Diameter of cookware (mm)
Multi Crown	180 - 260
Semi-rapid	120 - 220
Auxiliary	80 - 180

## 6.3 Hints and Tips for Hob<sup>2</sup>Hood

When you operate the hob with the function:

- Protect the hood panel from direct sunlight.
- Do not spot halogen light on the hood panel.
- Do not cover the hob control panel.
- Do not interrupt the signal between the hob and the hood (for example with a hand or a cookware handle). See the picture.

**The hood in the picture is only exemplary.**

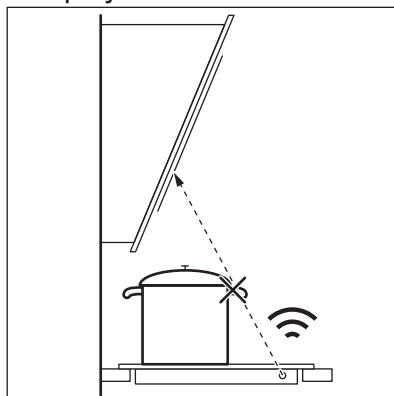

Keep the window for Hob<sup>2</sup>Hood infrared signal communicator clean.



Other remotely controlled appliances may block the signal. Do not use any remotely controlled appliances at the time when you use the function on the hob.

### Cooker hoods with the Hob<sup>2</sup>Hood function

To find the full range of cooker hoods which work with this function refer to our consumer website. The AEG cooker hoods that work with this function must have the symbol .

## 7. CARE AND CLEANING



### WARNING!

Refer to Safety chapters.

### 7.1 General information

- Clean the hob after each use.
- Always use cookware with a clean base.
- Scratches or dark stains on the surface have no effect on how the hob operates.
- Use a special cleaner suitable for the surface of the hob.



The presence of water or other liquids on the control panel can accidentally activate or deactivate the hob functions.



### WARNING!

Do not use knives, scrapers or similar instruments to clean the surface of the glass or the rims of the burners and the frame (if applicable).

- Wash stainless steel parts with water, and then dry them with a soft cloth.

### 7.2 Pan supports



The pan supports are not resistant to washing in a dishwasher. They must be washed by hand.

1. Remove the pan supports to easily clean the hob.



Be very careful when you replace the pan supports to prevent the hob top from damage.

2. The enamel coating occasionally can have rough edges, so be careful when you wash the pan supports by hand and dry them. If necessary, remove stubborn stains with a paste cleaner.
3. After you clean the pan supports, make sure that they are in correct positions.

4. For the burner to operate correctly, make sure that the arms of the pan supports are aligned with the centre of the burner.

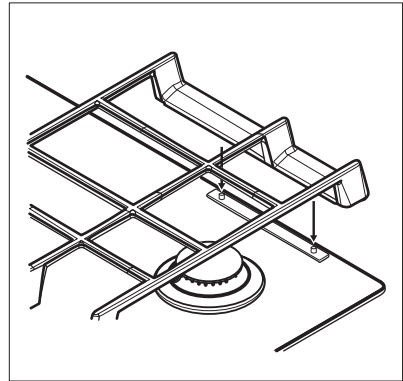

### 7.3 Removing pan supports

To keep the pan supports in the correct position, they are put on metal pins installed in the rear side of the hob. For easier cleaning, pan supports can be removed from the hob. Lift up the pan supports keeping them in horizontal position as shown in the graphic.



Do not lift the pan supports at an angle, as this will put strain on the metal pins. This can cause damage to the pins and cause them to break.

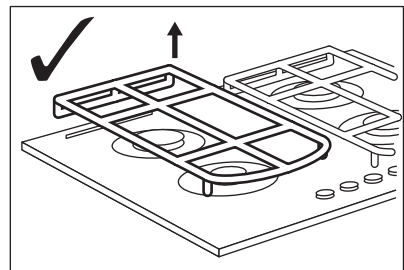

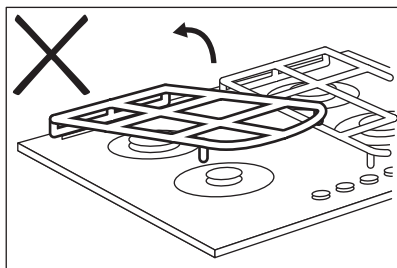
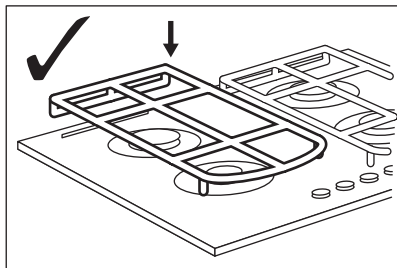

The shape of pan supports and the amount of burners can be different in other models of the appliance.

#### 7.4 Cleaning the hob

- **Remove immediately:** melted plastic, plastic foil, sugar and food with sugar,

otherwise, the dirt can cause damage to the hob. Take care to avoid burns.

- **Remove when the hob is sufficiently cool:** limescale rings, water rings, fat stains, shiny metallic discoloration. Clean the hob with a moist cloth and a non-abrasive detergent. After cleaning, wipe the hob dry with a soft cloth.
- To clean the enamelled parts, caps and crowns, wash them with warm soapy water and dry them carefully before you put them back on.

#### 7.5 Cleaning the spark plug

This feature is obtained through a ceramic ignition candle with a metal electrode. Keep these components well clean to prevent difficult lighting and check that the burner crown holes are not obstructed.

#### 7.6 Periodic maintenance

Speak to your local Authorised Service Centre periodically to check the conditions of the gas supply pipe and the pressure adjuster, if fitted.

## 8. TROUBLESHOOTING



**WARNING!**  
Refer to Safety chapters.

### 8.1 What to do if...

Problem	Possible cause	Remedy
There is no spark when you try to activate the spark generator.	The hob is not connected to an electrical supply or it is connected incorrectly.	Check if the hob is correctly connected to the electrical supply.
	The fuse is blown.	Make sure that the fuse is the cause of the malfunction. If the fuse is blown again and again, contact a qualified electrician.
	Burner cap and crown are placed incorrectly.	Place the burner cap and crown correctly.

Problem	Possible cause	Remedy
The flame extinguishes immediately after ignition.	Thermocouple is not heated up sufficiently.	After lighting the flame, keep the knob pushed for equal or less than 10 seconds.
The flame ring is uneven.	Burner crown is blocked with food residues.	Make sure that the injector is not blocked and the burner crown is clean.
The control panel brightness is reduced or it switches off.	The temperature of the plate is high. To ensure long life-time of the display the brightness is reduced depending on the temperature of the hob. Above a certain temperature the control panel switches off.	Let the hob cool down.
The control knob pilot lights turn on after connecting the hob to the mains or after a power outage.	Pilot light test.	Refer to "Installation".
Hob <sup>2</sup> Hood function does not work.	You covered the control panel.	Remove the object from the control panel.
You cannot activate or operate Hob <sup>2</sup> Hood and Minute Minder.	There is water or fat stains on the control panel.	Clean the control panel.

## 8.2 If you cannot find a solution...

If you cannot find a solution to the problem yourself, contact your dealer or an Authorised Service Centre. Give the data from the rating plate. Make sure, you operated the hob correctly. If not the servicing by a service technician or

dealer will not be free of charge, also during the warranty period. The instructions about the Service Centre and conditions of guarantee are in the guarantee booklet.

## 8.3 Labels supplied with the accessories bag

Stick the adhesive labels as indicated below:

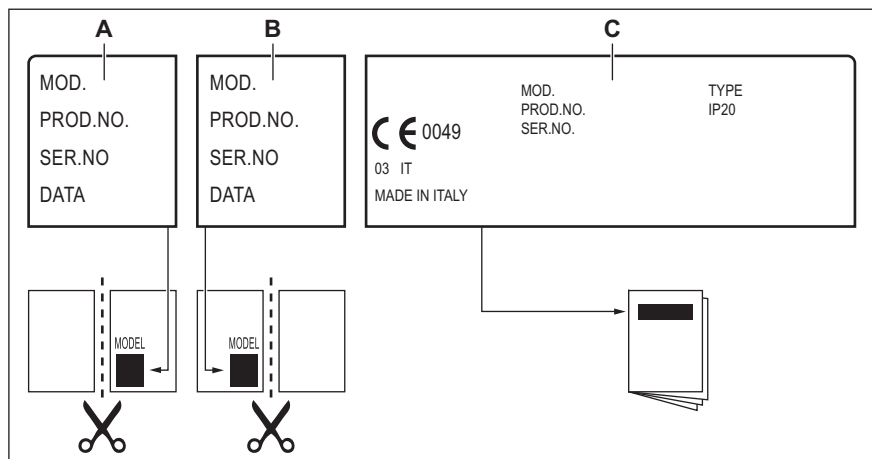

- A.** Stick it on Guarantee Card and send this part (if applicable).  
**B.** Stick it on Guarantee Card and keep this part (if applicable).  
**C.** Stick it on instruction booklet.

## 9. TECHNICAL DATA

### 9.1 Hob dimensions

Width	590 mm
Depth	520 mm

### 9.2 Bypass diameters

BURNER	Ø BYPASS 1/100 mm
Multi Crown	57
Semi-rapid	35
Auxiliary	28

### 9.3 Other technical data

TOTAL POWER:	Gas original:	G20 (2H) 20 mbar	8,9 kW
	Gas replacement:	G30 (3+) 28-30 mbar	607 g/h
		G31 (3+) 37 mbar	596 g/h
Electric supply:	220-240 V ~ 50-60 Hz 3 core flexible cable with non rewirable plug fitted with a 3 amp cartridge fuse		
Appliance category:	II2H3+		
Gas connection:	R 1/2"		
Appliance class:	3		

### 9.4 Gas burners for NATURAL GAS G20 20 mbar

BURNER	NORMAL POWER kW	MINIMUM POWER kW	INJECTOR MARK
Multi Crown	3,9	1,4	146
Semi-rapid	2,0	0,6	96x
Auxiliary	1,0	0,33	70



#### WARNING!

This appliance does not function with the existing gas settings if installed in Malta. Therefore, before connecting the appliance it is essential to change the nozzles according to the type of gas used according to the table below.

### 9.5 Gas burners for LPG G30/G31 28-30/37 mbar

BURNER	NORMAL POWER kW	MINIMUM POWER kW	INJECTOR MARK	NOMINAL GAS FLOW g/h	
				G30 28-30 mbar	G31 37 mbar
Multi Crown	3,55	1,4	095	258	254
Semi-rapid	1,9	0,6	71	138	136
Auxiliary	1,0	0,33	50	73	71



Data in the table is specified for Malta.

## 10. ENERGY EFFICIENCY

### 10.1 Product information according to EU 66/2014

Model identification	HKB64540NB, HKB64NB540	
Type of hob	Built-in hob	
Number of gas burners	4	
Energy efficiency per gas burner (EE gas burner)	Left rear - Semi-rapid	60.3%
	Right rear - Semi-rapid	60.3%
	Left front - Multi Crown	60.0%
	Right front - Auxiliary	not applicable
Energy efficiency for the gas hob (EE gas hob)	60.2%	

EN 30-2-1: Domestic cooking appliances burning gas - Part 2-1 : Rational use of energy - General

### 10.2 Energy saving

- Before use, make sure that the burners and pan supports are assembled correctly.
- Use cookware with diameters applicable to the size of burners.
- Center the pot on the burner.
- When you heat up water, use only the amount you need.
- If it is possible, always put the lids on the cookware.
- When the liquid starts to boil, turn down the flame to barely simmer the liquid.
- If it is possible, use a pressure cooker. Refer to its user manual.

## 11. ENVIRONMENTAL CONCERNS

Recycle materials with the symbol .  
Put the packaging in relevant containers to recycle it. Help protect the environment and human health by recycling waste of electrical and electronic appliances. Do not dispose of

appliances marked with the symbol  with the household waste. Return the product to your local recycling facility or contact your municipal office.

[www.aeg.com/shop](http://www.aeg.com/shop)



867345057-E-502018



**AEG**



## Free Manuals Download Website

<http://myh66.com>

<http://usermanuals.us>

<http://www.somanuals.com>

<http://www.4manuals.cc>

<http://www.manual-lib.com>

<http://www.404manual.com>

<http://www.luxmanual.com>

<http://aubethermostatmanual.com>

Golf course search by state

<http://golfingnear.com>

Email search by domain

<http://emailbydomain.com>

Auto manuals search

<http://auto.somanuals.com>

TV manuals search

<http://tv.somanuals.com>