

▶ BSB578270M
BSE578270M
BSS57807BM
BSS578270M

DE **Benutzerinformation**
Backofen

EN **User Manual**
Oven

FR **Notice d'utilisation**
Four

IT **Istruzioni per l'uso**
Forno

USER MANUAL



AEG

FÜR PERFEKTE ERGEBNISSE

Danke, dass Sie sich für dieses AEG Produkt entschieden haben. Wir haben es geschaffen, damit Sie viele Jahre von seiner ausgezeichneten Leistung und den innovativen Technologien, die Ihnen das Leben erleichtern, profitieren können. Es ist mit Funktionen ausgestattet, die in gewöhnlichen Geräten nicht vorhanden sind. Bitte nehmen Sie sich ein paar Minuten Zeit, um das Beste aus ihm herauszuholen.

Besuchen Sie uns auf unserer Website, um:



Anwendungshinweise, Prospekte, Informationen zu Fehlerbehebung, Service und Reparatur zu erhalten:

www.aeg.com/support



Registrieren Sie Ihr Produkt, um einen erstklassigen Service zu erhalten:

www.registreaeg.com



Um Zubehör, Verbrauchsmaterial und Original-Ersatzteile für Ihr Gerät zu kaufen:

www.aeg.com/shop



Für weitere Rezepte, Tipps und Fehlerbehebung laden Sie die App **My AEG Kitchen** herunter.





KUNDENDIENST UND SERVICE

Verwenden Sie immer Original-Ersatzteile.

Halten Sie folgende Angaben bereit, wenn Sie sich an einen autorisierten Kundendienst wenden: Modell, PNC, Seriennummer.

Die Daten finden Sie auf dem Typenschild.

-  Warnungs-/Sicherheitshinweise
-  Allgemeine Informationen und Empfehlungen
-  Informationen zum Umweltschutz

Änderungen vorbehalten.

INHALTSVERZEICHNIS

1. SICHERHEITSHINWEISE	4	2.8 Wartung.....	10
1.1 Sicherheit von Kindern und schutzbedürftigen Personen.....	4	2.9 Entsorgung.....	11
1.2 Allgemeine Sicherheit.....	5	3. MONTAGE	11
2. SICHERHEITSANWEISUNGEN	6	3.1 Montage.....	11
2.1 Montage.....	6	3.2 Befestigung des Ofens am Möbel..	12
2.2 Elektrischer Anschluss.....	7	4. GERÄTEBESCHREIBUNG	13
2.3 Gebrauch.....	8	4.1 Gesamtansicht.....	13
2.4 Reinigung und Pflege.....	9	4.2 Zubehör.....	13
2.5 Pyrolysereinigung.....	9	5. EIN- UND AUSSCHALTEN DES BACKOFENS	14
2.6 Dampfgaren.....	10	5.1 Versenkbare Knöpfe.....	14
2.7 Innenbeleuchtung.....	10		

5.2 Bedienfeld.....	14	11.2 Feuchte Umluft - Empfohlenes Zubehör.....	33
6. VOR DER ERSTEN VERWENDUNG.....	15	11.3 Gartabellen für Prüfinstitute.....	34
6.1 Erste Reinigung.....	15	12. REINIGUNG UND PFLEGE.....	35
6.2 Erstes Vorheizen.....	16	12.1 Hinweise zur Reinigung.....	36
6.3 Drahtlose Verbindung 	16	12.2 Entfernen: Einhängegitter.....	36
6.4 Softwarelizenzen.....	17	12.3 Benutzung:	
7. TÄGLICHER GEBRAUCH.....	17	Pyrolytische Reinigung.....	37
7.1 Einstellung: Ofenfunktionen.....	17	12.4 Erinnerungsfunktion Reinigen.....	38
7.2 Ofenfunktionen.....	18	12.5 Reinigung: Wassertank.....	38
7.3 Hinweise zu: Feuchte Umluft.....	19	12.6 Aus- und Einbau der: Tür.....	39
7.4 Wassertank.....	19	12.7 Austausch: Lampe.....	41
7.5 Einstellung: Koch-Assistent.....	20	13. FEHLERSUCHE.....	42
7.6 Koch-Assistent mit Rezepten.....	21	13.1 Was zu tun ist, wenn	42
8. UHRFUNKTIONEN.....	26	13.2 Servicedaten.....	44
8.1 Uhrfunktionen.....	26	14. ENERGIEEFFIZIENZ.....	44
8.2 Einstellung: Uhrfunktionen.....	27	14.1 Produktinformationen und Produktdatenblatt*.....	44
9. VERWENDUNG: ZUBEHÖR.....	28	14.2 Energiesparen.....	45
9.1 Einsetzen des Zubehörs.....	28	15. MENÜSTRUKTUR.....	46
9.2 Temperatursensor.....	29	15.1 Menü.....	46
10. ZUSATZFUNKTIONEN.....	31	16. UMWELTTIPPS.....	47
10.1 Verriegelung.....	31		
10.2 Automatische Abschaltung.....	31		
10.3 Kühlgebläse.....	31		
11. TIPPS UND HINWEISE.....	31		
11.1 Feuchte Umluft.....	31		



1. ⚠ SICHERHEITSHINWEISE

Lesen Sie vor der Montage und dem Gebrauch des Geräts zuerst die Bedienungsanleitung. Bei Verletzungen oder Schäden infolge nicht ordnungsgemäßer Montage oder Verwendung übernimmt der Hersteller keine Haftung. Bewahren Sie die Anleitung zum Nachschlagen an einem sicheren und zugänglichen Ort auf.

1.1 Sicherheit von Kindern und schutzbedürftigen Personen

- Das Gerät kann von Kindern ab 8 Jahren und Personen mit eingeschränkten physischen, sensorischen oder geistigen Fähigkeiten oder mit mangelnder Erfahrung/mangelndem Wissen benutzt werden, wenn sie durch eine für ihre Sicherheit zuständige Person beaufsichtigt werden oder von dieser Person Anweisungen erhalten haben, wie das Gerät sicher zu bedienen ist und welche Gefahren bei nicht ordnungsgemäßer Bedienung bestehen. Kinder unter 8 Jahren und Personen mit schweren Behinderungen oder

Mehrfachbehinderung sollten vom Gerät ferngehalten werden, wenn sie nicht ständig beaufsichtigt werden.

- Kinder sollten beaufsichtigt werden, um sicherzustellen, dass sie nicht mit dem Gerät und mit Mobilgeräten über My AEG Kitchen spielen.
- Halten Sie sämtliches Verpackungsmaterial von Kindern fern und entsorgen Sie es ordnungsgemäß.
- **WARNUNG:** Halten Sie Kinder und Haustiere von dem Gerät fern, wenn es in Betrieb oder in der Abkühlphase ist. Die zugänglichen Geräteteile werden beim Betrieb sehr heiß.
- Falls Ihr Gerät mit einer Kindersicherung ausgestattet ist, empfehlen wir, diese einzuschalten.
- Kinder dürfen keine Reinigung und Wartung des Geräts ohne Beaufsichtigung durchführen.

1.2 Allgemeine Sicherheit

- Die Montage des Geräts und der Austausch des Kabels muss von einer Fachkraft vorgenommen werden.
- Verwenden Sie das Gerät nicht, bevor es in den Einbauschrank gesetzt wird.
- Vor Wartungsarbeiten ist das Gerät von der elektrischen Stromversorgung zu trennen.
- Wenn das Netzkabel beschädigt ist, muss es vom Hersteller, seinem autorisierten Kundenservice oder einer gleichermaßen qualifizierten Person ausgetauscht werden, um Gefahren durch elektrischen Strom zu vermeiden.
- **WARNUNG:** Vergewissern Sie sich, dass das Gerät ausgeschaltet ist, bevor Sie die Lampe austauschen, um einen Stromschlag zu vermeiden.
- **WARNUNG:** Das Gerät und die zugänglichen Geräteteile werden während des Betriebs heiß. Seien Sie vorsichtig und berühren Sie niemals die Heizelemente.
- Verwenden Sie stets Topfhandschuhe, um Zubehör oder Geschirr zu entfernen oder zu verstauen.

SICHERHEITSANWEISUNGEN

- Verwenden Sie ausschließlich den für dieses Gerät empfohlenen KT Sensor (Kerntempersensur).
- Ziehen Sie die Einhängegitter zuerst vorne und dann hinten von den Seitenwänden weg. Setzen Sie die Einhängegitter in umgekehrter Reihenfolge ein.
- Reinigen Sie das Gerät nicht mit einem Dampfstrahlreiniger.
- Benutzen Sie zum Reinigen der Glastür keine scharfen Scheuermittel oder Metallschwämmchen; sie könnten die Glasfläche verkratzen und zum Zersplittern der Scheibe führen.
- Vor der pyrolytischen Reinigung müssen verschüttete Flüssigkeiten entfernt werden. Nehmen Sie das gesamte Zubehör aus dem Backofen.

2. SICHERHEITSANWEISUNGEN

2.1 Montage

**WARNUNG!**

Die Montage des Geräts darf nur von einer qualifizierten Fachkraft durchgeführt werden.

- Entfernen Sie das gesamte Verpackungsmaterial.
- Montieren Sie ein beschädigtes Gerät nicht und benutzen Sie es nicht.
- Halten Sie sich an die mitgelieferte Montageanleitung.
- Seien Sie beim Umsetzen des Gerätes vorsichtig, da es sehr schwer ist. Tragen Sie stets Sicherheitshandschuhe und festes Schuhwerk.
- Ziehen Sie das Gerät nicht am Griff.
- Montieren Sie das Gerät an einem sicheren und geeigneten Ort, der den Montageanforderungen entspricht.
- Die Mindestabstände zu anderen Geräten und Küchenmöbeln sind einzuhalten.
- Überprüfen Sie vor der Montage des Gerätes, ob sich die Ofentür ohne Kraftanwendung öffnen lässt.
- Das Gerät ist mit einem elektrischen Kühlsystem ausgestattet. Es muss mit der elektrischen Stromversorgung betrieben werden.

Mindesthöhe des Einbaumöbels (Mindesthöhe des Schrankes unter der Arbeitsplatte)	590 (600) mm
Schrankbreite	560 mm
Schranktiefe	550 (550) mm

Höhe der Gerätevorderseite	594 mm
Höhe der Geräterückseite	576 mm
Breite der Gerätevorderseite	595 mm
Breite der Geräterückseite	559 mm
Gerätetiefe	569 mm
Geräteeinbautiefe	548 mm
Tiefe bei geöffneter Tür	1022 mm
Mindestgröße der Belüftungsöffnung. Öffnung auf der Rückseite unten	560x20 mm
Länge des Netzanschlusskabels. Das Kabel befindet sich in der rechten Ecke auf der Rückseite	1500 mm
Befestigungsschrauben	4x25 mm

2.2 Elektrischer Anschluss



WARNUNG!

Brand- und Stromschlaggefahr.

- Alle elektrischen Anschlüsse sind von einem geprüften Elektriker vorzunehmen.
- Das Gerät muss geerdet sein.
- Stellen Sie sicher, dass die Daten auf dem Typenschild mit den elektrischen Nennwerten der Netzspannung übereinstimmen.
- Schließen Sie das Gerät nur an eine ordnungsgemäß installierte Schutzkontaktsteckdose an.
- Verwenden Sie keine Mehrfachsteckdosen oder Verlängerungskabel.
- Achten Sie darauf, Netzstecker und Netzkabel nicht zu beschädigen. Falls das Netzkabel des Geräts ersetzt werden muss, lassen Sie diese Arbeit durch unseren autorisierten Kundendienst durchführen.
- Achten Sie darauf, dass das Netzkabel die Gerätetür oder die Nische unter dem Gerät nicht berührt oder in ihre Nähe gelangt, insbesondere wenn das Gerät eingeschaltet oder die Tür heiß ist.
- Alle Teile, die gegen direktes Berühren schützen, sowie die isolierten Teile müssen so befestigt werden, dass sie nicht ohne Werkzeug entfernt werden können.
- Stecken Sie den Netzstecker erst nach Abschluss der Montage in die Steckdose. Stellen Sie sicher, dass der Netzstecker nach der Montage noch zugänglich ist.
- Falls die Steckdose lose ist, schließen Sie den Netzstecker nicht an.
- Ziehen Sie nicht am Netzkabel, wenn Sie das Gerät von der Stromversorgung trennen möchten. Ziehen Sie stets am Netzstecker.

SICHERHEITSANWEISUNGEN

- Verwenden Sie nur geeignete Trenneinrichtungen: Überlastschalter, Sicherungen (Schraubsicherungen müssen aus dem Halter entfernt werden können), Fehlerstromschutzschalter und Schütze.
- Die elektrische Installation muss eine Trenneinrichtung aufweisen, mit der Sie das Gerät allpolig von der Stromversorgung trennen können. Die Trenneinrichtung muss mit einer Kontaktöffnungsbreite von mindestens 3 mm ausgeführt sein.
- Schließen Sie die Gerätetür ganz, bevor Sie den Netzstecker in die Steckdose stecken.
- Das Gerät wird mit einem Netzstecker und Netzkabel geliefert.

Einsetzbare Kabeltypen für Einbau oder Austausch in Europa:

H07 RN-F, H05 RN-F, H05 RRF, H05 VV-F, H05 V2V2-F (T90), H05 BB-F

Für den Kabelabschnitt siehe die Gesamtleistung auf dem Typenschild. Sie können auch die Tabelle heranziehen:

Gesamtleistung (W)	Kabelquerschnitt (mm ²)
maximal 1380	3 x 0.75
maximal 2300	3 x 1
maximal 3680	3 x 1.5

Das Erdkabel (grün/gelb) muss 2 cm länger sein als die Phasen- und Nullleiter (blaue und braune Kabel).

2.3 Gebrauch



WARNUNG!

Verletzungs-, Verbrennungs-, Stromschlag- oder Explosionsgefahr.

- Dieses Gerät ist ausschließlich zur Verwendung im Haushalt (in Innenräumen) bestimmt.
- Nehmen Sie keine technischen Änderungen am Gerät vor.
- Vergewissern Sie sich, dass die Lüftungsöffnungen nicht blockiert sind.
- Lassen Sie das Gerät während des Betriebs nicht unbeaufsichtigt.
- Schalten Sie das Gerät nach jedem Gebrauch aus.
- Gehen Sie beim Öffnen der Tür vorsichtig vor, wenn das Gerät in Betrieb ist. Es kann heiße Luft freigesetzt werden.
- Benutzen Sie das Gerät nicht mit nassen Händen oder wenn es mit Wasser Kontakt hat.
- Üben Sie keinen Druck auf die offene Tür aus.
- Verwenden Sie das Gerät nicht als Arbeits- oder Abstellfläche.
- Öffnen Sie die Gerätetür vorsichtig. Die Verwendung von Zutaten mit Alkohol kann eine Mischung aus Alkohol und Luft verursachen.
- Lassen Sie beim Öffnen der Tür keine Funken oder offenen Flammen mit dem Gerät in Kontakt kommen.
- Platzieren Sie keine entflammaren Produkte oder Gegenstände, die mit entflammaren Produkten benetzt sind, im Gerät, auf dem Gerät oder in der Nähe des Geräts.
- Geben Sie Ihr Wi-Fi-Passwort nicht weiter.

**WARNUNG!**

Risiko von Schäden am Gerät.

- Um Beschädigungen und Verfärbungen der Emailbeschichtung zu vermeiden:
 - Stellen Sie feuerfestes Geschirr oder andere Gegenstände nicht direkt auf den Boden des Geräts.
 - Legen Sie keine Alufolie direkt auf den Boden des Garraums.
 - Füllen Sie kein Wasser in das heiße Gerät.
 - Lassen Sie nach Abschluss des Garvorgangs kein feuchtes Geschirr oder feuchte Speisen im Gerät stehen.
 - Gehen Sie beim Herausnehmen oder Einsetzen des Zubehörs sorgfältig vor.
- Verfärbungen der Emaille- oder Edelstahlbeschichtung haben keine Auswirkung auf die Leistung des Geräts.
- Verwenden Sie eine tiefe Pfanne für feuchte Kuchen. Fruchtsäfte verursachen Flecken, die dauerhaft sein können.
- Dieses Gerät ist nur zum Kochen bestimmt. Es darf nicht für andere Zwecke z. B. zum Erwärmen von Räumen verwendet werden.
- Die Backofentür muss beim Betrieb geschlossen sein.
- Ist das Gerät hinter einer Möbelfront (wie etwa einer Tür) installiert, achten Sie darauf, dass die Tür während des Gerätebetriebs nicht geschlossen wird. Hinter einer geschlossenen Möbelfront können sich Hitze und Feuchtigkeit ansammeln und das Gerät, das Gehäuse oder den Boden beschädigen. Schließen Sie die Möbelfront nicht, bevor das Gerät nach dem Gebrauch völlig abgekühlt ist.

2.4 Reinigung und Pflege

**WARNUNG!**

Verletzungs-, Brandgefahr sowie Risiko von Schäden am Gerät.

- Schalten Sie das Gerät immer aus und ziehen Sie den Netzstecker aus der Steckdose, bevor Reinigungsarbeiten durchgeführt werden.
- Vergewissern Sie sich, dass das Gerät abgekühlt ist. Es besteht die Gefahr, dass die Glasscheiben brechen.
- Ersetzen Sie die Türglasscheiben umgehend, wenn sie beschädigt sind. Wenden Sie sich an einen autorisierten Kundendienst.
- Gehen Sie beim Aushängen der Tür vorsichtig vor. Die Tür ist schwer!
- Reinigen Sie das Gerät regelmäßig, um eine Verschlechterung des Oberflächenmaterials zu verhindern.
- Reinigen Sie das Geräts mit einem weichen, feuchten Tuch. Verwenden Sie ausschließlich Neutralreiniger. Benutzen Sie keine Scheuermittel, scheuernde Reinigungsschwämmchen, Lösungsmittel oder Metallgegenstände.
- Falls Sie ein Backofenspray verwenden, befolgen Sie die Sicherheitsanweisungen auf seiner Verpackung.

2.5 Pyrolysereinigung

**WARNUNG!**

Im Pyrolyse-Modus besteht Verletzungs- und Brandgefahr und es können chemische Emissionen (Dämpfe) austreten.

SICHERHEITSSANWEISUNGEN

- Entfernen Sie vor der pyrolytischen Selbstreinigung und vor der Erstinbetriebnahme Folgendes aus dem Ofeninnenraum:
 - Alle größeren Lebensmittelrückstände, Öl- und Fettablagerungen.
 - Alle zum Gerät dazugehörigen herausnehmbaren Teile (Bleche, Einhängegitter) sowie Töpfe, Pfannen, Bleche und Utensilien mit Antihafbeschichtung usw.
- Lesen Sie die Anleitung zur Pyrolyse sorgfältig durch.
- Halten Sie Kinder während der Pyrolyse vom Gerät fern.
Das Gerät wird sehr heiß, und aus den vorderen Kühlungsöffnungen tritt heiße Luft aus.
- Die pyrolytische Reinigung erfolgt bei sehr hoher Temperatur und kann Dämpfe von Lebensmittelrückständen und Gerätematerialien freisetzen. Beachten Sie unbedingt Folgendes:
 - Sorgen Sie während und nach der Pyrolyse für eine gute Belüftung.
 - Sorgen Sie während und nach dem ersten Gebrauch mit der Höchsttemperatur für eine gute Belüftung.
- Einige Vögel und Reptilien können im Gegensatz zu den Menschen sehr empfindlich auf die während des Reinigungsvorgangs freigesetzten Dämpfe von Pyrolyse-Backöfen reagieren.
 - Bringen Sie Tiere (besonders Vögel) für die Zeit während und nach der Pyrolyse und nach der ersten Anwendung der Höchsttemperatur in einen gut belüfteten Bereich.
- Kleine Tiere reagieren auch während des laufenden Reinigungsprogramms empfindlich auf die lokalen Temperaturschwankungen in der Nähe von Pyrolyse-Backöfen.
- Antihafbeschichtungen auf Töpfen, Pfannen, Blechen und Kochutensilien usw. können durch die hohen Temperaturen während der pyrolytischen Reinigung beschädigt werden und geringfügige Mengen an gesundheitsschädlichen Dämpfen freisetzen.
- Die von den Pyrolyse-Backöfen/Speiseresten freigesetzten Dämpfe sind ungefährlich für Menschen, einschließlich Kinder und Personen mit Gesundheitsbeschwerden.

2.6 Dampfaren



WARNUNG!

Verbrennungsgefahr sowie Risiko von Schäden am Gerät.

- Freigesetzter Dampf kann Verbrennungen verursachen:
 - Öffnen Sie während des Dampfarens nicht die Gerätetür.
 - Öffnen Sie die Gerätetür vorsichtig nach dem Dampfaren.

2.7 Innenbeleuchtung



WARNUNG!

Stromschlaggefahr.

- Bezüglich der Lampe(n) in diesem Gerät und separat verkaufter Ersatzlampen: Diese Lampen müssen extremen physikalischen Bedingungen in Haushaltsgeräten standhalten, wie z.B. Temperatur, Vibration, Feuchtigkeit, oder sollen Informationen über den Betriebszustand des Gerätes anzeigen. Sie sind nicht für den Einsatz in anderen Geräten vorgesehen und nicht für die Raumbeleuchtung geeignet.
- Verwenden Sie nur Lampen mit der gleichen Leistung .

2.8 Wartung

- Wenden Sie sich zur Reparatur des Geräts an den autorisierten Kundendienst.
- Dabei dürfen ausschließlich Originalersatzteile verwendet werden.

2.9 Entsorgung



WARNUNG!

Verletzungs- und Erstickungsgefahr.

- Informationen zur Entsorgung des Geräts erhalten Sie von Ihrer Gemeindeverwaltung.
- Trennen Sie das Gerät von der Stromversorgung.
- Schneiden Sie das Netzkabel in der Nähe des Geräts ab, und entsorgen Sie es.
- Entfernen Sie das Türschloss, um zu verhindern, dass sich Kinder, oder Haustiere im Gerät einschließen.

3. MONTAGE



WARNUNG!

Siehe Kapitel Sicherheitshinweise.

3.1 Montage



YouTube

www.youtube.com/electrolux
www.youtube.com/aeg

How to install your AEG/Electrolux
Oven - Column installation

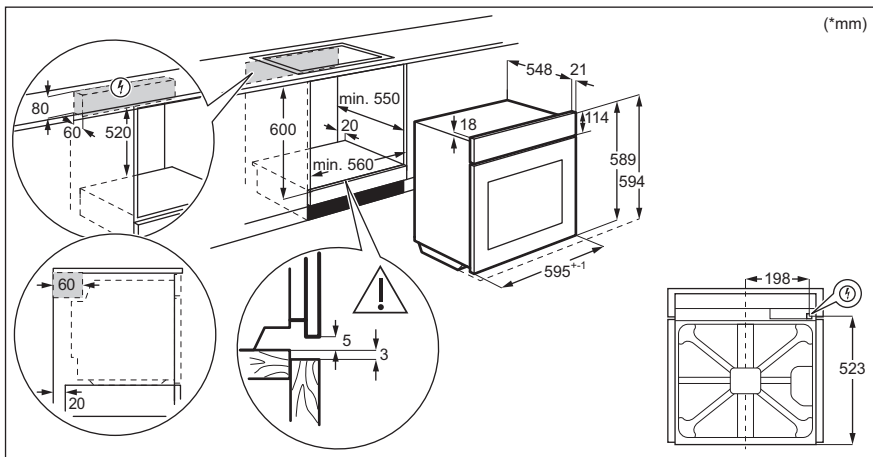

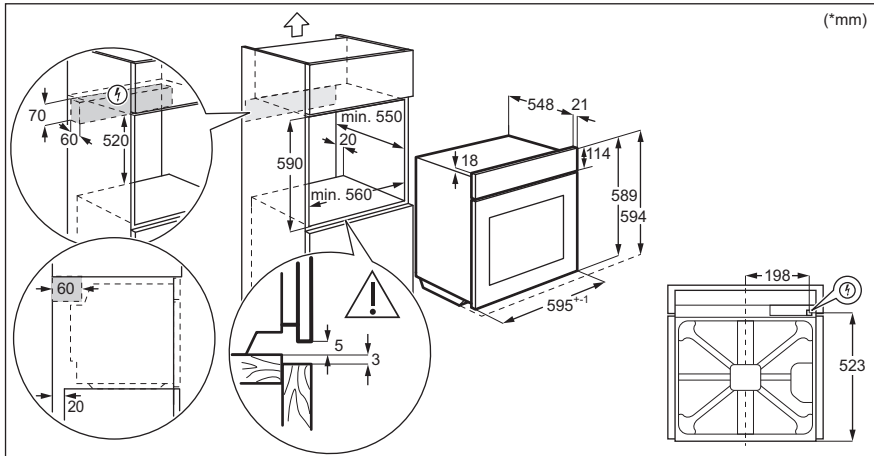

3.2 Befestigung des Ofens am Möbel

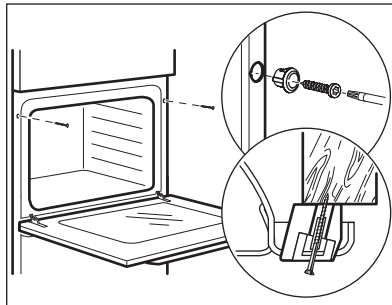

4. GERÄTEBESCHREIBUNG

4.1 Gesamtansicht

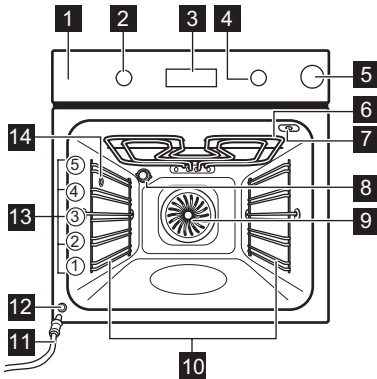

- 1** Bedienfeld
- 2** Einstellknopf für die Ofenfunktionen
- 3** Anzeige
- 4** Einstellknopf
- 5** Wassertank
- 6** Heizelement
- 7** Buchse für den Temperatursensor
- 8** Lampe
- 9** Ventilator
- 10** Einschubschienen, herausnehmbar
- 11** Ablaufschlauch
- 12** Wasserauslassventil
- 13** Einschubebenen
- 14** Dampfeinlass

4.2 Zubehör







- **Kombirost**
Für Kochgeschirr, Kuchenformen, Braten.
- **Backblech**
Für Kuchen und Plätzchen.
- **Brat- und Fettpfanne**
Zum Backen und Braten oder als Pfanne zum Aufsammeln von Fett.
- **Temperatursensor**
Zum Messen der restlichen Garzeit.

5. EIN- UND AUSSCHALTEN DES BACKOFENS

5.1 Versenkbare Knöpfe

Drücken Sie zum Benutzen des Geräts den Knopf. Der Knopf kommt dann heraus.





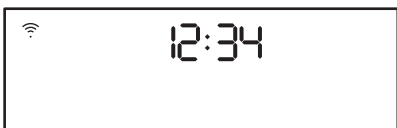
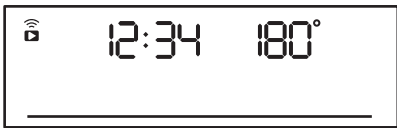
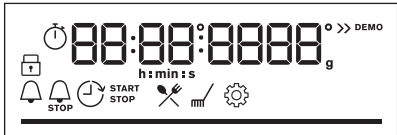











5.2 Bedienfeld

Sensorfelder des Bedienfelds					Drücken Sie	Drehen Sie den Knopf
 Kurzzeit- wecker	 Schnell- aufhei- zung	 Back- ofen- be- leuch- tung	 Temperatur- sensor	OK		
Wählen Sie eine Ofenfunktion, um den Backofen einzuschalten.						
Drehen Sie den Knopf für die Ofenfunktionen in die Aus-Position, um den Backofen auszuschalten.						

	Wenn sich der Einstellknopf für die Ofenfunktionen in der Aus-Position befindet, schaltet das Display in den Standby-Modus.
	Wenn Sie kochen, zeigt das Display die eingestellte Temperatur, Uhrzeit und andere verfügbare Optionen an.
	Display mit der maximalen Anzahl wählbarer Funktionen.

Display-Anzeigen





VOR DER ERSTEN VERWENDUNG

 Verriegelung	 Koch-Assistent	 Reinigung	 Einstellungen	 Schnellaufheizung
Timer-Anzeigen:		 STOP		
Wi-Fi Anzeige - blinkt, wenn der Backofen mit WLAN verbunden werden kann.			Fernsteuerung-Anzeige – Der Backofen kann aus der Ferne gesteuert werden.	
 Die Wi-Fi-Verbindung ist eingeschaltet.			 Fernsteuerung ist eingeschaltet.	
Fortschrittsbalken - für Temperatur oder Zeit.				
Wassertank-Füllstandsanzeigen				
				
Temperatursensor Kontrolllampe				



6. VOR DER ERSTEN VERWENDUNG

 **WARNUNG!**
Siehe Kapitel Sicherheitshinweise.

6.1 Erste Reinigung

Reinigen Sie den leeren Backofen vor der ersten Inbetriebnahme und stellen Sie die Uhrzeit ein:			
			 00:00 angezeigt. Stellen Sie die Zeit ein. Drücken Sie OK.

6.2 Erstes Vorheizen

Heizen Sie den leeren Ofen vor der ersten Inbetriebnahme vor.	
Schritt 1	Nehmen Sie die Zubehörteile und die herausnehmbaren Einhängegitter aus dem Ofen.
Schritt 2	Stellen Sie die Höchsttemperatur für folgende Funktion ein:  Lassen Sie den Ofen 1 Stunde lang eingeschaltet.
Schritt 3	Stellen Sie die Höchsttemperatur für folgende Funktion ein:  Lassen Sie den Ofen 15 Min. lang eingeschaltet.
<p> Der Ofen kann während des Vorheizens Geruch und Rauch verströmen. Stellen Sie sicher, dass der Raum belüftet ist.</p>	

6.3 Drahtlose Verbindung

Zur Verbindung des Ofens benötigen Sie:

- Ein drahtloses Netzwerk mit Internetverbindung.
- Ein Mobilgerät, das mit Ihrem drahtlosen Netzwerk verbunden ist.

Schritt 1	Laden Sie die mobile App herunter My AEG Kitchen und folgen Sie den Anweisungen für die nächsten Schritte.
Schritt 2	Drehen Sie den Knopf, um Folgendes auszuwählen:  .

Frequenz	2,4 GHz WLAN	5 GHz WLAN
	2.400 - 2.483,5 MHz	5.150 - 5.350 MHz 5.470 - 5.725 MHz
Protokoll	IEEE 802.11b DSSS, 802.11g/n OFDM	IEEE 802.11a/n OFDM
Max. Leistung	EIRP < 20 dBm (100 mW)	EIRP < 23 dBm (200 mW)
Wi-Fi-Modul	NIU5-50	

Frequenz Bluetooth	2.400 - 2.483,5 MHz
Protokoll	LE: DSSS

Max. Leistung	EIRP < 4 dBm (2,5 mW)
---------------	-----------------------

Länder, die von der Bestimmung der Richtlinie 2014/53/EU erfasst sind: Belgien, Bulgarien, Tschechische Republik, Dänemark, Deutschland, Estland, Irland, Griechenland, Spanien, Frankreich, Kroatien, Italien, Zypern, Lettland, Litauen, Luxemburg, Ungarn, Malta, Niederlande, Nordirland, Österreich, Polen, Portugal, Rumänien, Slowenien, Slowakei, Finnland, Schweden, Norwegen, Island, Liechtenstein, Schweiz, Türkei.

6.4 Softwarelizenzen

Die Software in diesem Produkt enthält Bauteile, die auf kostenloser und Open-Source-Software basieren. AEG anerkennt die Beiträge der offenen Software- und Roboter-Communities zum Entwicklungsprojekt.

Um den Quellcode dieser kostenlosen und Open-Source-Software-Bauteile aufzurufen, deren Lizenzbedingungen veröffentlicht werden müssen, und um deren vollständige Copyright-Informationen und Lizenzbedingungen einzusehen, besuchen Sie bitte: <http://aeg.opensoftwarerepository.com> (Ordner NIU5).

7. TÄGLICHER GEBRAUCH



WARNUNG!







Siehe Kapitel Sicherheitshinweise.

7.1 Einstellung: Ofenfunktionen

Beginnen Sie mit dem Kochen	
Schritt 1	Schritt 2
Stellen Sie eine Backofenfunktion ein.	Stellen Sie die Temperatur ein.





Garen mit Dampf				
Schritt 1	Schritt 2	Schritt 3	Schritt 4	Schritt 5





TÄGLICHER GEBRAUCH

Garen mit Dampf				
			 	 °C
Drücken Sie auf den Deckel des Wassertanks, um ihn zu öffnen.	Füllen Sie den Wassertank mit 900 ml Wasser.	Schieben Sie den Wassertank in seine ursprüngliche Position.	Stellen Sie die Dampfheizfunktion ein.	Stellen Sie die Temperatur ein.

7.2 Ofenfunktionen

Standard-Ofenfunktionen

Ofenfunktion	Gerät
 Heißluft	Zum Backen auf bis zu drei Einschubebenen gleichzeitig und zum Dörren von Lebensmitteln. Stellen Sie eine 20 - 40 °C niedrigere Backofentemperatur als bei Ober-/Unterhitze ein.
 Ober-/Unterhitze	Zum Backen und Braten von Speisen auf einer Einschubebene.
 Feuchtigkeit, niedrig	Diese Funktion ist geeignet für Fleisch, Geflügel, Ofengerichte und Aufläufe. Durch die Kombination von Dampf und Hitze werden Fleischstücke zart und saftig und erhalten eine knusprige Oberfläche.
 Pizzastufe	Zum Backen von Pizza. Für ein intensives Überbacken und einen knusprigen Boden.
 Unterhitze	Zum Backen von Kuchen mit knusprigen Böden und zum Einkochen von Lebensmitteln.

Ofenfunktion	Gerät
 Tiefkühlgerichte	Lässt Fertiggerichte (z. B. Pommes frites, Kroketten oder Frühlingsrollen) schön knusprig werden.
 Feuchte Umluft	Diese Funktion ist entwickelt worden, um während des Kochvorgangs Energie zu sparen. Wenn Sie diese Funktion nutzen, kann die Temperatur im Garraum von der eingestellten Temperatur abweichen. Es wird die Restwärme genutzt. Die Wärmeleistung kann geringer sein. Weitere Informationen zu folgenden Themen finden Sie im Kapitel „Täglicher Gebrauch“: Feuchte Umluft.
 Grill	Zum Grillen dünner Lebensmittel und zum Toasten von Brot.
 Heißluftgrillen	Zum Braten großer Fleischstücke oder von Geflügel mit Knochen auf einer Ebene. Zum Gratinieren und Überbacken.
 Menü	Aufrufen des Menüs: Koch-Assistent, Reinigung, Einstellungen.

7.3 Hinweise zu: Feuchte Umluft



Diese Funktion wurde zur Bestimmung der Energieeffizienzklasse und den Anforderungen an die umweltgerechte Gestaltung EU 65/2014 und EU 66/2014 verwendet. Tests nach EN 60350-1.

Die Backofentür sollte während des Garvorgangs geschlossen bleiben, damit die Funktion nicht unterbrochen wird. So wird gewährleistet, dass der Backofen mit der höchsten Energieeffizienz arbeitet.

Wenn Sie diese Funktion verwenden, schaltet sich die Backofenbeleuchtung automatisch nach 30 Sekunden aus.

Näheres zum Garen finden Sie im Kapitel „Tipps und Hinweise“, Feuchte Umluft. Allgemeine Empfehlungen zum Energiesparen finden Sie im Kapitel „Energieeffizienz“, Energiesparen.

7.4 Wassertank

Wassertank-Füllstandsanzeige	
	Der Tank ist voll.
	Der Tank ist halb voll.

TÄGLICHER GEBRAUCH

Wassertank-Füllstandsanzeige	
	Der Tank ist leer. Füllen Sie den Tank auf.
Wenn Sie zu viel Wasser in den Tank füllen, leitet der Sicherheitsauslass das überschüssige Wasser in den Boden des Garraums. Saugen Sie das Wasser mit einem Schwamm auf.	

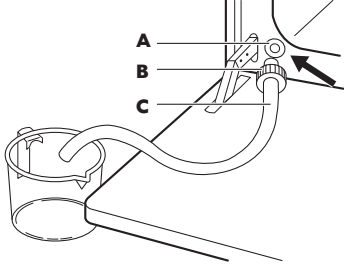
Entleeren des Wasserbehälters		
Schritt t 1	Schalten Sie den Backofen aus, lassen Sie ihn bei geöffneter Tür stehen und warten Sie, bis der Backofen abgekühlt ist.	
Schritt t 2	Schließen Sie den Abflussschlauch (C) am Auslassventil (A) über das Verbindungsteil (B) an.	
Schritt t 3	Halten Sie wiederholt das Ende des Schlauchs unter der Höhe A und B, damit das restliche Wasser aufgefangen werden kann.	
Schritt t 4	Nehmen Sie C und B ab, und trocknen Sie den Backofen mit einem weichen Schwamm.	





7.5 Einstellung: Koch-Assistent

Jedes Gericht in diesem Untermenü hat eine empfohlene Funktion und Temperatur. Sie können die Zeit und Temperatur während des Garvorgangs einstellen.





Einige der Speisen können Sie auch mit der folgenden Funktion zubereiten:	Die Garstufe für die Speise:
<ul style="list-style-type: none"> • Temperatursensor 	<ul style="list-style-type: none"> • Blutig • Mittel • Durch

Koch-Assistent - Verwenden Sie diese Funktion, um ein Gericht schnell mit den Standardeinstellungen zuzubereiten:			
Schritt 1	Schritt 2	Schritt 3	Schritt 4



Koch-Assistent - Verwenden Sie diese Funktion, um ein Gericht schnell mit den Standardeinstellungen zuzubereiten:

			
Öffnen Sie das Menü.	Wählen Koch-Assistent. Drücken Sie OK .	Wählen Sie das Gericht. Drücken Sie OK .	Geben Sie das Gericht in den Backofen. Bestätigen Sie die Einstellung.











7.6 Koch-Assistent mit Rezepten

















Legende	
	Temperatursensor verfügbar. Platzieren Sie Temperatursensor im dicksten Teil des Gerichts. Der Backofen schaltet sich ab, wenn die eingestellte Temperatursensor Temperatur erreicht ist.
	Geben Sie Wasser in den Wassertank.
	Heizen Sie den Backofen vor, bevor Sie mit dem Kochen beginnen.
	Einschubebene.

Wenn die Funktion beendet ist, prüfen Sie, ob das Gericht fertig ist.





























	Speise	Gewicht	Einschubebene / Zubehör	Dauer
Rindfleisch 🍖				
P1	Roastbeef, blutig	1 - 1,5 kg; 4 - 5 cm dicke Stücke	  2 Backblech Braten Sie das Fleisch einige Minuten in einer heißen Pfanne. Setzen Sie es in den Backofen ein.	~ 40 Min.
P2	Roastbeef, rosa			~ 50 Min.
P3	Roastbeef, durch			~ 60 Min.





















TÄGLICHER GEBRAUCH

	Speise	Gewicht	Einschubebene / Zubehör	Dauer
P4	Steak, rosa	180 - 220 g pro Stück; 3 cm dicke Scheiben	  3; Bräter auf Kombirost Braten Sie das Fleisch einige Minuten in einer heißen Pfanne. Setzen Sie es in den Backofen ein.	~ 15 Min.
P5	Rinderbraten/ geschmort (Prime Rib, obere runde, dicke Flanke)	1,5 - 2 kg	  2; Bräter auf Kombirost Braten Sie das Fleisch einige Minuten in einer heißen Pfanne. Flüssigkeit hinzugeben. Setzen Sie es in den Backofen ein.	~ 120 Min.
P6	Roastbeef, blutig (Niedertemperatur-Garen)	1 - 1,5 kg; 4 - 5 cm dicke Stücke	  2; Backblech Verwenden Sie Ihre Lieblingsgewürze oder einfach Salz und frisch gemahlene Pfeffer. Braten Sie das Fleisch einige Minuten in einer heißen Pfanne. Setzen Sie es in den Backofen ein.	~ 75 Min.
P7	Roastbeef, rosa (Niedertemperatur-Garen)			~ 85 Min.
P8	Roastbeef, durch (Niedertemperatur-Garen)			~ 130 Min.
P9	Filet, blutig (Niedertemperatur-Garen)	0,5 - 1,5 kg; 5 - 6 cm dicke Stücke	  2; Backblech Verwenden Sie Ihre Lieblingsgewürze oder einfach Salz und frisch gemahlene Pfeffer. Braten Sie das Fleisch einige Minuten in einer heißen Pfanne. Setzen Sie es in den Backofen ein.	~ 75 Min.
P10	Filet, rosa (Niedertemperatur-Garen)			~ 90 Min.
P11	Filet, fertig (Niedertemperatur-Garen)			~ 120 Min.
Kalb 				
P12	Kalbsbraten (z. B. Schulter)	0,8 - 1,5 kg; 4 cm dicke Stücke	  2; Bräter auf Kombirost Verwenden Sie Ihre Lieblingsgewürze. Flüssigkeit hinzugeben. Braten zugeeckt.	~ 80 Min.













	Speise	Gewicht	Einschubebene / Zubehör	Dauer
Schweinefleisch 				
P13	Schweinebraten oder Schulter	1,5 - 2 kg	   1; Bräter auf Kombirost Wenden Sie das Fleisch nach der Hälfte der Gardauer.	~ 165 Min.
P14	Pulled Pork LTC	1,5 - 2 kg	  2; Backblech Verwenden Sie Ihre Lieblingsgewürze. Wenden Sie das Fleisch nach der Hälfte der Garzeit, um eine gleichmäßige Bräunung zu erzielen.	~ 215 Min.
P15	Lende, frisch	1 - 1,5 kg; 5 - 6 cm dicke Stücke	  2; Bräter auf Kombirost Verwenden Sie Ihre Lieblingsgewürze.	~ 55 Min.
P16	Rippchen	2 - 3 kg; roh, 2 - 3 cm dünne Rippchen	 3; tiefe Pfanne Flüssigkeit hinzufügen, um den Boden eines Gerichts zu bedecken. Wenden Sie das Fleisch nach der Hälfte der Gardauer.	90 Min.
Lamm 				
P17	Lammkeule mit Knochen	1,5 - 2 kg; 7 - 9 cm dicke Stücke	  2; Bräter auf Backblech Flüssigkeit hinzugeben. Wenden Sie das Fleisch nach der Hälfte der Gardauer.	~ 130 Min.
Geflügel 				
P18	Hähnchen, ganz	1 - 1,5 kg; frisch	  2 Auflaufform auf Backblech Verwenden Sie Ihre Lieblingsgewürze. Das Hähnchen nach der Hälfte der Garzeit wenden, um eine gleichmäßige Bräunung zu erzielen.	~ 60 Min.
P19	Halbes Hähnchen	0,5 - 0,8 kg	  3; Backblech Verwenden Sie Ihre Lieblingsgewürze.	~ 40 Min.

TÄGLICHER GEBRAUCH

	Speise	Gewicht	Einschubebene / Zubehör	Dauer
P20	Hähnchenbrust	180 - 200 g pro Stück	   2 Auflaufform auf Kombirost Verwenden Sie Ihre Lieblingsgewürze. Braten Sie das Fleisch einige Minuten in einer heißen Pfanne.	~ 25 Min.
P21	Hähnchenschenkel, frisch	-	   3; Backblech Wenn Sie zuerst Hähnchenschenkel marinieren, stellen Sie die niedrigere Temperatur ein und garen Sie länger.	~ 30 Min.
P22	Ente, ganz	2 - 3 kg	   2; Bräter auf Kombirost Verwenden Sie Ihre Lieblingsgewürze. Legen Sie das Fleisch in den Bräter. Die Ente nach der Hälfte der Garzeit wenden.	~ 100 Min.
P23	Gans, ganz	4 - 5 kg	   2; tiefe Pfanne Verwenden Sie Ihre Lieblingsgewürze. Legen Sie das Fleisch auf das tiefe Backblech. Die Gans nach der Hälfte der Garzeit wenden.	~ 110 Min.
Sonstige 				
P24	Hackbraten	1 kg	   2; Kombirost Verwenden Sie Ihre Lieblingsgewürze.	~ 60 Min.
 Fisch				
P25	Fisch, gegrillt	0,5 - 1 kg pro Fisch	   2; Backblech Fisch mit Butter füllen und Ihre Lieblingsgewürze und Kräuter verwenden.	~ 30 Min.
P26	Fischfilet	-	   3 Auflaufform auf Kombirost Verwenden Sie Ihre Lieblingsgewürze.	35 Min.
Süßes Backen/Desserts   				
P27	Käsekuchen	-	  2;  Springform 28 cm auf Kombirost	90 Min.





	Speise	Gewicht	Einschubebene / Zubehör	Dauer
P28	Apfelkuchen	-	 3; Backblech	45 Min.
P29	Apfelkuchen	-	 2; Kuchenform auf Kombirost	40 Min.
P30	Apfelkuchen	-	 1; 22 cm Kuchenform auf  Kombi-rost	60 Min.
P31	Brownies	2 kg	 3; tiefe Pfanne	30 Min.
P32	Schokoladenmuffins	-	 3; Muffin-Blech auf Kombirost	25 Min.
P33	Brotkuchen	-	 2; Brotpfanne auf Kombirost	50 Min.
Gemüse / Beilagen   				
P34	Kartoffeln	1 kg	 2; Backblech Die ganzen Kartoffeln mit der Haut auf das Backblech geben.	50 Min.
P35	Wegdes	1 kg	 3; Backblech mit Backpapier auskleidet Verwenden Sie Ihre Lieblingsgewürze. Kartoffeln in Stücke schneiden.	35 Min.
P36	Gegrilltes Gemüse	1 - 1,5 kg	 3; Backblech mit Backpapier auskleidet Verwenden Sie Ihre Lieblingsgewürze. Gemüse in Stücke schneiden.	30 Min.
P37	Kroketten, gefroren	0,5 kg	 3; Backblech	25 Min.
P38	Pommes frites, gefroren	0,75 kg	 3; Backblech	25 Min.
Gratins, Brot und Pizza   				
P39	Lasagne / Nudelauflauf	1 - 1,5 kg	  2; Auflaufform auf Kombirost	55 Min.

UHRFUNKTIONEN



	Speise	Gewicht	Einschubebene / Zubehör	Dauer
P40	Kartoffelgratin	1 - 1,5 kg	  1; Auflaufform auf Kombirost	60 Min.
P41	Pizza frisch, dünn	-	   2 Backblech mit Backpapier auskleidet	35 Min.
P42	Pizza frisch, dick	-	  2; Backblech mit Backpapier auskleidet	25 Min.
P43	Quiche	-	 2; Backform auf Kombirost	45 Min.
P44	Baguette/ Ciabatta/ Weißbrot	0,8 kg	   2; Backblech mit Backpapier auskleidet Mehr Zeit für Weißbrot.	50 Min.
P45	Alle Getreide/ Roggen/dunkles Brot, alle Getreide	1 kg	  2; Backblech mit Backpapier / Kombirost	60 Min.







8. UHRFUNKTIONEN







8.1 Uhrfunktionen

Uhrfunktion	Verwendung
	Kurzzeit-Wecker. Nach Ablauf der Zeit ertönt der Signalton.
	Garzeitdauer. Nach Ablauf des Timers ertönt ein akustisches Signal und die Ofenfunktion stoppt.
	Zeitvorwahl. Verzögerung des Starts und/oder Endes des Kochens.
	Uptimer. Max. 23 Std. 59 Min. Diese Funktion wirkt sich nicht auf den Betrieb des Backofens aus. Um den Uptimer ein- oder auszuschalten, wählen Sie: Menü, Einstellungen.

8.2 Einstellung: Uhrfunktionen

Einstellung: Uhrzeit		
Schritt 1	Schritt 2	Schritt 3
		
Um die Uhrzeit zu ändern, rufen Sie das Menü auf und wählen Sie Einstellungen, Tageszeit.	Stellen Sie die Uhrzeit ein.	Drücken Sie: OK.

Einstellung: Kurzzeit-Wecker			
Schritt 1	Im Display wird Folgendes angezeigt: 0:00 angezeigt. 	Schritt 2	Schritt 3
			
Drücken Sie:  .		Stellen Sie Kurzzeit-Wecker	Drücken Sie: OK.
 Der Countdown des Timers startet umgehend.			

Einstellung: Garzeitdauer				
Schritt 1	Schritt 2	Im Display wird Folgendes angezeigt: 0:00 angezeigt.  <small>STOP</small>	Schritt 3	Schritt 4
				
Wählen Sie eine Ofenfunktion und stellen Sie die Temperatur ein.	Drücken Sie wiederholt:  .		Stellen Sie die Gardauer ein.	Drücken Sie: OK.
 Der Countdown des Timers startet umgehend.				

VERWENDUNG: ZUBEHÖR

Einstellung: Zeitvorwahl							
Schritt 1	Schritt 2		Schritt 3	Schritt 4		Schritt 5	Schritt 6
		Das Display zeigt die Uhrzeit an START 			Im Display wird Folgendes angezeigt: --:--  STOPP		
Wählen Sie die Ofenfunktion.	Drücken Sie wiederholt: 		Stellen Sie die Startzeit ein.	Drücken Sie: OK.		Stellen Sie die Endzeit ein.	Drücken Sie: OK.
 Der Countdown des Timers beginnt zu der eingestellten Startzeit.							

9. VERWENDUNG: ZUBEHÖR

9.1 Einsetzen des Zubehörs

Die kleine Einkerbung auf der Oberseite erhöht die Sicherheit. Die Vertiefungen sind auch Kippsicherungen. Durch den umlaufend erhöhten Rand des Rosts ist das Kochgeschirr gegen Abrutschen vom Rost gesichert.

Kombirost:

Schieben Sie den Rost zwischen die Führungsschienen der Einhängegitter mit den Füßen nach unten zeigend.

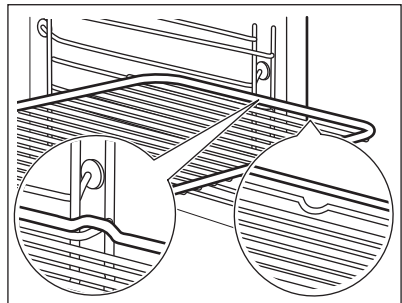

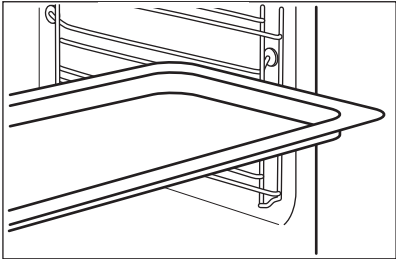
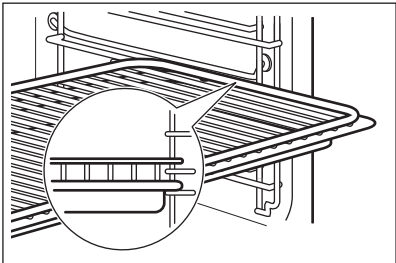
<p>Backblech / Auflaufpfanne: Schieben Sie das Backblech zwischen die Führungsstäbe der Einhängegitter.</p>	
<p>Kombirost, Backblech / Auflaufpfanne: Schieben Sie das Backblech zwischen die Führungsstäbe der Einhängegitter und dem Kombirost auf die Führungsstäbe darüber.</p>	

9.2 Temperatursensor

Temperatursensor misst die Temperatur im Inneren der Speise.



Es gibt zwei Temperatureinstellungen:	
<p style="text-align: center;">°C Die Backofentemperatur.</p>	<p style="text-align: center;"> Die Backofentemperatur.</p>

Für beste Garergebnisse:		
Die Zutaten sollten Raumtemperatur haben.	Verwenden Sie ihn nicht für flüssige Speisen.	Er muss während des Garvorgangs in der Speise bleiben.

Benutzung: Temperatursensor

<p>Schritt 1</p>	Schalten Sie den Backofen ein.
<p>Schritt 2</p>	Stellen Sie die Ofenfunktion und, falls notwendig, die Temperatur ein.

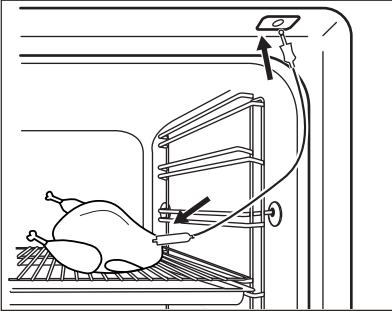
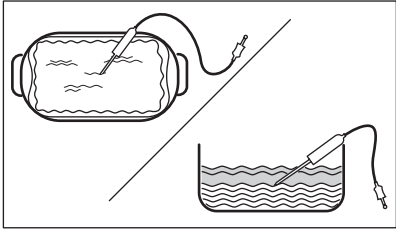
VERWENDUNG: ZUBEHÖR

Schritt 3	Einsetzen: Temperatursensor.
Fleisch, Geflügel und Fisch	Auflauf
Führen Sie die Spitze des Temperatursensor so ein, dass er sich in der Mitte des Fleischstücks oder Fisches befindet, möglichst im dicksten Teil. Achten Sie darauf, dass sich mindestens 3/4 des Temperatursensor in der Speise befinden.	Führen Sie die Spitze des Temperatursensor so ein, dass sie sich in der Mitte des Auflaufs befindet. Temperatursensor sollte während des Backvorgangs an einer Stelle abgestützt werden. Verwenden Sie hierzu etwas Festes. Verwenden Sie den Rand des Gerichts, um den Silikongriff der Temperatursensor zu stützen. Die Spitze der Temperatursensor darf den Boden der Backform nicht berühren.
	
Schritt 4	Stecken Sie den Stecker des Temperatursensor in die Buchse an der Vorderseite des Ofens. Das Display zeigt die aktuelle Temperatur an: Temperatursensor.
Schritt 5	Drücken Sie  , um die Kerntemperatur des Sensors einzustellen.
Schritt 6	OK - Zur Bestätigung drücken. Wenn die Speise die eingestellte Temperatur erreicht, ertönt ein Signalton. Sie können den Garprozess anhalten oder fortsetzen, um sicherzustellen, dass die Speise durchgegart ist.
Schritt 7	Ziehen Sie den Stecker des Temperatursensor aus der Buchse und nehmen Sie das Gericht aus dem Ofen. <div style="border: 1px solid black; padding: 5px;"> WARNUNG! Es besteht Verbrennungsgefahr, da der Temperatursensor heiß wird. Seien Sie vorsichtig, wenn Sie den Stecker ziehen und den Sensor aus dem Gargut nehmen.</div>

10. ZUSATZFUNKTIONEN

10.1 Verriegelung

Diese Funktion verhindert ein versehentliches Verstellen der Ofenfunktion.

Einschalten, wenn der Backofen in Betrieb ist – das eingestellte Garen wird fortgesetzt und das Bedienfeld ist verriegelt.

Einschalten, wenn der Backofen ausgeschaltet ist – der Backofen kann nicht eingeschaltet werden, das Bedienfeld ist verriegelt.





 OK – gedrückt halten, um die Funktion einzuschalten. Ein Signal ertönt.

 OK – gedrückt halten, um sie auszuschalten.

 3 x  – blinkt, wenn die Verriegelung eingeschaltet ist.

10.2 Automatische Abschaltung

Der Backofen wird aus Sicherheitsgründen nach einiger Zeit ausgeschaltet, wenn eine Ofenfunktion eingeschaltet ist und Sie die Einstellungen nicht ändern.

 (°C)	 (Std.)
30 - 115	12.5
120 - 195	8.5
200 - 245	5.5
250 - max.	3

Die Abschaltautomatik funktioniert nicht mit den Funktionen: Backofenbeleuchtung, Temperatursensor, Zeitvorwahl.

10.3 Kühlgebläse





Wenn der Backofen in Betrieb ist, wird das Kühlgebläse automatisch eingeschaltet, um die Ofenoberflächen zu kühlen. Wenn Sie den Backofen ausschalten kann das Kühlgebläse weiter laufen, bis der Ofen abgekühlt ist.





11. TIPPS UND HINWEISE

11.1 Feuchte Umluft

Beachten Sie für beste Ergebnisse die unten in der Tabelle aufgeführten Empfehlungen.



TIPPS UND HINWEISE

		 (°C)		 (Min.)
Brötchen, süß, 16 Stück	Backblech oder tiefes Blech	180	2	20 - 30
Brötchen, 9 Stück	Backblech oder tiefes Blech	180	2	30 - 40
Pizza, gefroren, 0,35 kg	Kombirost	220	2	10 - 15
Biskuitrolle	Backblech oder tiefes Blech	170	2	25 - 35
Brownie	Backblech oder tiefes Blech	175	3	25 - 30
Soufflé, 6 Stück	Keramikförmchen auf Kombirost	200	3	25 - 30
Biskuitboden	Biskuitform auf Kombirost	180	2	15 - 25
Englischer Sandwichkuchen à la Victoria	Backform auf Kombirost	170	2	40 - 50
Fisch, pochiert, 0,3 kg	Backblech oder tiefes Blech	180	3	20 - 25
Fisch, ganz, 0,2 kg	Backblech oder tiefes Blech	180	3	25 - 35
Fischfilet, 0,3 kg	Pizzapfanne auf Kombirost	180	3	25 - 30
Fleisch, pochiert, 0,25 kg	Backblech oder tiefes Blech	200	3	35 - 45
Schaschlik, 0,5 kg	Backblech oder tiefes Blech	200	3	25 - 30
Plätzchen, 16 Stück	Backblech oder tiefes Blech	180	2	20 - 30

		 (°C)		 (Min.)
Makronen, 24 Stück	Backblech oder tiefes Blech	180	2	25 - 35
Muffins, 12 Stück	Backblech oder tiefes Blech	170	2	30 - 40
Kleingebäck, pikant, 20 Stück	Backblech oder tiefes Blech	180	2	25 - 30
Mürbeteigplätzchen, 20 Stück	Backblech oder tiefes Blech	150	2	25 - 35
Törtchen, 8 Stück	Backblech oder tiefes Blech	170	2	20 - 30
Gemüse, pochiert, 0,4 kg	Backblech oder tiefes Blech	180	3	35 - 45
Vegetarisches Omelett	Pizzapfanne auf Kombi-rost	200	3	25 - 30
Mediterranes Gemüse, 0,7 kg	Backblech oder tiefes Blech	180	4	25 - 30

11.2 Feuchte Umluft - Empfohlenes Zubehör







Verwenden Sie die dunklen und nicht reflektierenden Formen und Behälter. Sie haben eine bessere Wärmeabsorption als helle Farbe und reflektierende Schüsseln.







			
Pizzapfanne	Backform	Förmchen	Tortenbodenform
Dunkel, nicht reflektierend 28 cm Durchmesser	Dunkel, nicht reflektierend 26 cm Durchmesser	Keramikform 8 cm Durchmesser, 5 cm Höhe	Dunkel, nicht reflektierend 28 cm Durchmesser

11.3 Gartabellen für Prüfinstitute

Informationen für Prüfinstitute

Tests gemäß IEC 60350-1.

				 (°C)	 (Min.)	
Törtchen, 20 pro Blech	Ober-/ Unterhitze	Backblech	3	170	20 - 30	-
Törtchen, 20 pro Blech	Heißluft	Backblech	3	150 - 160	20 - 35	-
Törtchen, 20 pro Blech	Heißluft	Backblech	2 und 4	150 - 160	20 - 35	-
Apfelkuchen, 2 Formen à Ø 20 cm	Ober-/ Unterhitze	Kombirost	2	180	70 - 90	-
Apfelkuchen, 2 Formen à Ø 20 cm	Heißluft	Kombirost	2	160	70 - 90	-
Biskuit, Kuchenform Ø 26 cm	Ober-/ Unterhitze	Kombirost	2	170	40 - 50	Backofen 10 Minuten vorheizen.
Biskuit, Kuchenform Ø 26 cm	Heißluft	Kombirost	2	160	40 - 50	Backofen 10 Minuten vorheizen.

				 (°C)	 (Min.)	
Biskuit, Kuchenform Ø 26 cm	Heißluft	Kombirost	2 und 4	160	40 - 60	Backofen 10 Minuten vorheizen.
Mürbe- teigge- bäck	Heißluft	Back- blech	3	140 - 150	20 - 40	-
Mürbe- teigge- bäck	Heißluft	Back- blech	2 und 4	140 - 150	25 - 45	-
Mürbe- teigge- bäck	Ober-/ Unterhitze	Back- blech	3	140 - 150	25 - 45	-
Toast, 4 - 6 Stück	Grill	Kombirost	4	Max.	2 - 3 Mi- nuten auf der ers- ten Seite, 2 - 3 Mi- nuten auf der zwei- ten Seite	Backofen 3 Minu- ten vorheizen.
Hambur- ger aus Rind- fleisch, 6 Stück, 0,6 kg	Grill	Kombirost und Fett- pfanne	4	Max.	20 - 30	Kombirost in die vierte und Fett- pfanne in die drit- te Einschubebene des Backofens einschieben. Wenden Sie das Gericht nach der Hälfte der Gar- dauer. Backofen 3 Minu- ten vorheizen.



12. REINIGUNG UND PFLEGE



WARNUNG!

Siehe Kapitel Sicherheitshinweise.

12.1 Hinweise zur Reinigung

 <p>Reinigungs- mittel</p>	<p>Feuchten Sie ein weiches Tuch mit warmem Wasser und etwas mildem Reinigungsmittel an, und reinigen Sie damit die Vorderseite des Backofens.</p>
	<p>Reinigen Sie die Metalloberflächen mit einer Reinigungslösung.</p>
	<p>Reinigen Sie Flecken mit einem milden Reinigungsmittel.</p>
 <p>Täglicher Ge- brauch</p>	<p>Reinigen Sie den Garraum nach jedem Gebrauch. Fettansammlungen oder andere Speisereste könnten einen Brand verursachen.</p>
	<p>Es kann sich Feuchtigkeit im Ofen oder an den Glasscheiben der Tür niederschlagen. Um die Kondensation zu reduzieren, schalten Sie den Backofen immer 10 Minuten vor dem Garen ein. Lassen Sie die Speisen nicht länger als 20 Minuten im Backofen stehen. Trocknen Sie den Garraum nach jedem Gebrauch mit einem weichen Tuch ab.</p>
 <p>Zubehör</p>	<p>Reinigen Sie alle Zubehörteile nach jedem Gebrauch und lassen Sie sie trocknen. Feuchten Sie ein weiches Tuch mit warmem Wasser und einem milden Reinigungsmittel an. Reinigen Sie die Zubehörteile nicht im Geschirrpüler.</p>
	<p>Reinigen Sie das Zubehör mit Antihafbeschichtung nicht mit Scheuermitteln oder scharfkantigen Gegenständen.</p>

12.2 Entfernen: Einhängegitter

Entfernen Sie Eihängegitter zur Reinigung des Backofens.

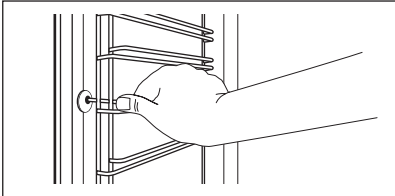
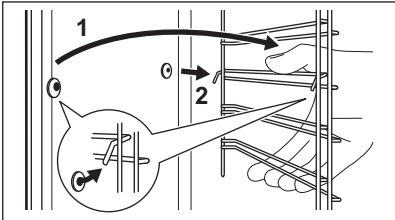
<p>Schritt 1</p>	<p>Schalten Sie den Backofen aus und warten Sie, bis er abgekühlt ist.</p>	
<p>Schritt 2</p>	<p>Ziehen Sie das Eihängegitter vorne von der Seitenwand weg.</p>	
<p>Schritt 3</p>	<p>Ziehen Sie das Eihängegitter hinten von der Seitenwand weg und nehmen Sie es heraus.</p>	
<p>Schritt 4</p>	<p>Führen Sie zum Einsetzen der Eihängegitter die oben aufgeführten Schritte in umgekehrter Reihenfolge durch.</p>	

12.3 Benutzung: Pyrolytische Reinigung

Reinigen Sie den Backofen mit Pyrolytische Reinigung.



WARNUNG!

Es besteht das Risiko von Verbrennungen.



VORSICHT!

Befinden sich weitere Geräte in demselben Küchenmöbel, verwenden Sie diese nicht während dieser Funktion. Andernfalls kann der Backofen beschädigt werden.

Vor dem Pyrolytische Reinigung:

Schalten Sie den Backofen aus und warten Sie, bis er abgekühlt ist.	Entfernen Sie alle Zubehörteile aus dem Backofen.	Reinigen Sie den Backofenboden und die innere Türglasscheibe mit warmem Wasser, einem weichen Tuch und einem milden Reinigungsmittel.
---	---	---

Pyrolytische Reinigung

Schritt 1	Menü eingeben: Reinigung .	
	Option	Dauer
	C1 - Leichte Reinigung	1 h
	C2 - Normale Reinigung	1 h 30 min
	C3 - Gründliche Reinigung	2 h 30 min
Schritt 2	OK - drücken, um das Reinigungsprogramm auszuwählen.	
Schritt 3	OK - Drücken, um die Reinigung zu starten.	
Schritt 4	Drehen Sie nach der Reinigung den Knopf für die Backofenfunktionen in die Aus-Position.	
Während der Reinigung ist die Backofenlampe ausgeschaltet.		
Sobald der Backofen die eingestellte Temperatur erreicht hat, wird die Tür verriegelt. Bis die Tür entriegelt wird, zeigt das Display Folgendes an: .		

Nach Abschluss der Reinigung:

Schalten Sie den Backofen aus und warten Sie, bis er abgekühlt ist.	Reinigen Sie den Garraum mit einem weichen Tuch.	Entfernen Sie die Rückstände vom Garraumboden.
---	--	--

12.4 Erinnerungsfunktion Reinigen

Der Backofen erinnert Sie daran, wann er mit der pyrolytischen Reinigung gereinigt werden muss.

 blinkt 5 Sekunden nach jedem Kochvorgang im Display.	Zum Ausschalten der Erinnerung geben Sie die Menü ein und wählen Sie Einstellungen, Erinnerungsfunktion Reinigen.
--	---





12.5 Reinigung: Wassertank

Schritt 1	Schalten Sie den Backofen aus.
Schritt 2	Setzen Sie eine Auflauffanne unter dem Dampfeinlass ein.
Schritt 3	Füllen Sie Wasser in den Wassertank: 850 ml. Zitronensäure hinzugeben: 5 Teelöffel. Warten Sie 60 Min.
Schritt 4	Schalten Sie dann den Ofen ein und stellen Sie die Funktion ein: Feuchtigkeit niedrig. Stellen Sie die Temperatur auf 230 °C. Schalten Sie den Backofen nach 25 Min. aus und warten Sie, bis er abgekühlt ist.
Schritt 5	Schalten Sie dann den Ofen ein und stellen Sie die Funktion ein: Feuchtigkeit niedrig. Stellen Sie die Temperatur auf 130 bis 230 °C. Schalten Sie den Backofen nach 10 Min. aus und warten Sie, bis er abgekühlt ist.
 Leeren Sie den Wassertank nach dem Dampfgaren, um Kalkrückstände zu verhindern.	

Nach Abschluss der Reinigung:

Schalten Sie den Backofen aus.	Leeren Sie den Wassertank. Siehe Kapitel Täglicher Gebrauch, „Entleeren des Wassertanks“.	Spülen Sie den Wassertank aus und reinigen Sie die restlichen Kalkrückstände mit einem weichen Tuch.	Reinigen Sie das Ablaufrohr mit warmem Wasser und einem milden Spülmittel.
--------------------------------	---	--	--

Die Tabelle unten zeigt den Wasserhärtebereich (dH) mit dem zugehörigen Kalkgehalt und die Qualität des Wassers. Übersteigt die Wasserhärte 4, füllen Sie den Wassertank mit abgefülltem Wasser.

Wasserhärte		Teststreifen	Kalkgehalt (mg/l)	Wassereinstufung	Reinigen Sie den Wassertank alle
Ebene	dH				
1	0 - 7		0 - 50	weich	75 Zyklen - 2,5 Monate
2	8 - 14		51 - 100	mittelhart	50 Zyklen - 2 Monate
3	15 - 21		101 - 150	hart	40 Zyklen - 1,5 Monate
4	22 - 28		über 151	sehr hart	30 Zyklen - 1 Monat

12.6 Aus- und Einbau der: Tür

Die Backofentür hat drei Glasscheiben. Die Backofentür und die inneren Glasscheiben können zur Reinigung herausgenommen werden. Lesen Sie die gesamte Anleitung „Aus- und Einbauen der Tür“, bevor Sie die Glasscheiben entfernen.



VORSICHT!

Benutzen Sie den Backofen nicht ohne die Glasscheiben.

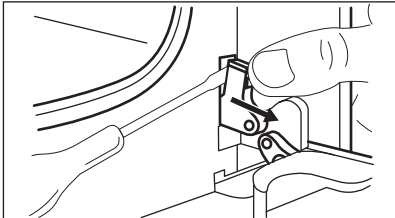
Schritt 1	Öffnen Sie die Backofentür vollständig und suchen Sie nach dem Scharnier auf der rechten Seite der Tür.	
Schritt 2	Benutzen Sie einen Schraubenzieher, um den rechten Scharnierhebel anzuheben und zu drehen.	

REINIGUNG UND PFLEGE

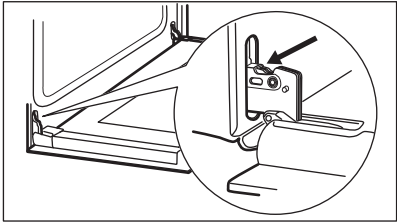
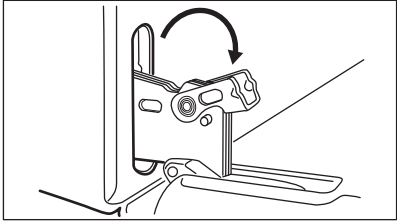
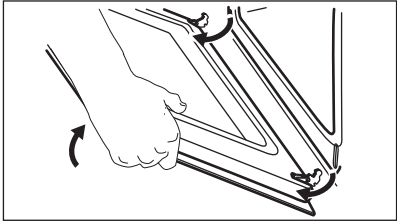
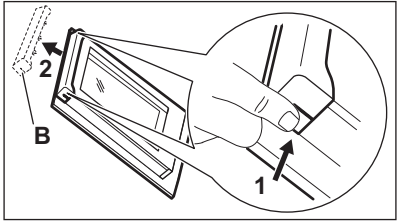
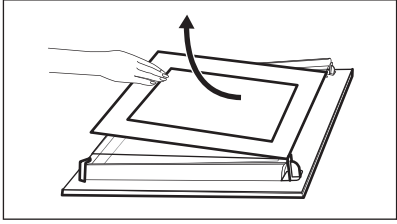
<p>Schritt 3</p>	<p>Fassen Sie das Scharnier auf der linken Seite der Tür an.</p>	
<p>Schritt 4</p>	<p>Heben und drehen Sie den Hebel am linken Scharnier vollständig.</p>	
<p>Schritt 5</p>	<p>Schließen Sie die Backofentür halb bis zur ersten Raststellung. Anschließend heben und ziehen Sie die Tür nach vorn aus der Aufnahme heraus.</p>	
<p>Schritt 6</p>	<p>Legen Sie die Backofentür auf ein weiches Tuch auf einer stabilen Fläche.</p>	
<p>Schritt 7</p>	<p>Fassen Sie die Türabdeckung (B) an der Oberkante der Tür an beiden Seiten an. Drücken Sie sie nach innen, um den Klippverschluss zu lösen.</p>	
<p>Schritt 8</p>	<p>Ziehen Sie die Türabdeckung nach vorn, um sie abzunehmen.</p>	
<p>Schritt 9</p>	<p>Halten Sie die Oberkanten der Türglasscheiben fest und ziehen Sie sie vorsichtig nacheinander heraus. Beginnen Sie mit der obersten Glasscheibe. Achten Sie darauf, dass die Glasscheiben vollständig aus den Halterungen gezogen werden.</p>	
<p>Schritt 10</p>	<p>Reinigen Sie die Glasscheiben mit Wasser und Spülmittel. Trocknen Sie die Glasscheiben sorgfältig ab. Reinigen Sie die Glasscheiben nicht im Geschirrspüler.</p>	
<p>Schritt 11</p>	<p>Setzen Sie nach der Reinigung die Glasscheiben und die Backofentür ein.</p>	

Achten Sie beim Wiedereinsetzen der Glasscheiben (A und B) auf die richtige Reihenfolge. Überprüfen Sie das Symbol/den Aufdruck auf der Seite der Glasscheibe. Jede Glasscheibe sieht anders aus, um den Aus- und Einbau zu erleichtern.
Bei korrektem Einbau macht die Türabdeckung ein Klickgeräusch.
Achten Sie darauf, die mittlere Glasscheibe richtig in die Aufnahmen einzusetzen.

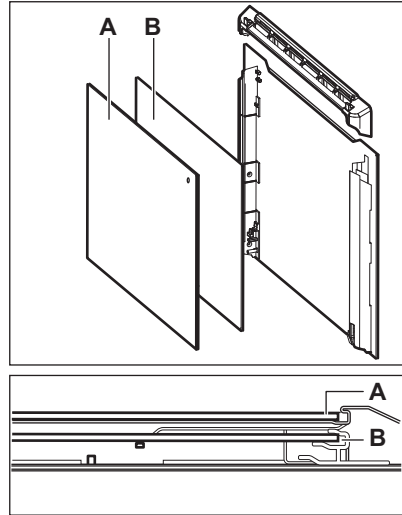

12.7 Austausch: Lampe



WARNUNG!

Stromschlaggefahr.
Die Lampe kann heiß sein.

Halten Sie die Halogenlampe stets mit einem Tuch, um zu verhindern, dass Fettrückstände auf der Lampe einbrennen.

Bevor Sie die Lampe austauschen:

Schritt 1	Schritt 2	Schritt 3
Schalten Sie den Backofen aus. Warten Sie, bis der Ofen kalt ist.	Trennen Sie den Ofen von der Netzversorgung.	Breiten Sie ein Tuch auf dem Garraumboden aus.

Hintere Lampe

Schritt 1	Drehen Sie die Glasabdeckung und nehmen Sie sie ab.
Schritt 2	Reinigen Sie die Glasabdeckung.

Schritt 3	Ersetzen Sie die Lampe durch eine geeignete, bis 300 °C hitzebeständige Lampe.
Schritt 4	Bringen Sie die Glasabdeckung wieder an.

13. FEHLERSUCHE



WARNUNG!

Siehe Kapitel Sicherheitshinweise.



13.1 Was zu tun ist, wenn ...

In allen Fällen, die nicht in dieser Tabelle aufgeführt sind, wenden Sie sich bitte an einen autorisierten Kundendienst.

Der Backofen schaltet sich nicht ein oder heizt nicht auf	
Störung	Prüfen Sie, ob Folgendes zutrifft ...
Der Backofen kann nicht eingeschaltet oder bedient werden.	Der Backofen ist ordnungsgemäß an die Spannungsversorgung angeschlossen.
Der Backofen heizt nicht auf.	Die ist Abschaltautomatik ausgeschaltet.
Der Backofen heizt nicht auf.	Die Backofen-Tür ist geschlossen.
Der Backofen heizt nicht auf.	Die Sicherung ist nicht durchgebrannt.
Der Backofen heizt nicht auf.	Die Kindersicherung ist ausgeschaltet.

Komponenten	
Störung	Prüfen Sie, ob Folgendes zutrifft ...
Die Lampe ist ausgeschaltet.	Feuchte Umluft - ist eingeschaltet.
Die Lampe funktioniert nicht.	Die Lampe ist durchgebrannt.
Der Temperatursensor funktioniert nicht.	Der Stecker des Temperatursensor ist vollständig in die Buchse eingesteckt.

Fehlercodes	
Im Display erscheint ...	Prüfen Sie, ob Folgendes zutrifft ...
Err C2	Sie haben den Temperatursensor Stecker aus der Buchse entfernt.
Err C3	Die Backofen-Tür ist geschlossen und die Türverriegelung ist nicht beschädigt.
Err F102	Die Backofen-Tür ist geschlossen.
Err F102	Die Türverriegelung nicht defekt ist.
00:00 angezeigt.	Es gab einen Stromausfall. Stellen Sie die Uhrzeit ein.
<p>Wenn das Display einen Fehlercode anzeigt, der nicht in dieser Tabelle enthalten ist, schalten Sie die Haussicherung aus und wieder ein, um den Ofen neu zu starten. Wenn der Fehlercode erneut angezeigt wird, wenden Sie sich an einen autorisierten Kundendienst.</p>	

Reinigung	
Störung	Prüfen Sie, ob Folgendes zutrifft ...
Es befindet sich Wasser in der Trommel.	Es ist nicht zu viel Wasser im Wassertank.
 - Anzeige leuchtet nicht.	Es ist genug Wasser im Wassertank. Wenn bereits Wasser in den Ofeninnenraum dringt, die Anzeige jedoch noch immer nicht aufleuchtet, wenden Sie sich an den autorisierten Kundendienst.
 - Anzeige leuchtet.	Es ist nicht genug Wasser im Wassertank. Wenn der Tank voll ist und die Anzeige immer noch leuchtet, wenden Sie sich an den autorisierten Kundendienst.
Die Funktion Dampfgaren wird nicht ausgeführt.	Es sind keine Kalkrückstände in der Dampfeinlassöffnung vorhanden.
Die Funktion Dampfgaren wird nicht ausgeführt.	Wasser ist im Wassertank.

Reinigung	
Das Entleeren des Wassertanks dauert länger als drei Minuten, oder es tritt Wasser aus der Dampfeinlassöffnung aus.	Es sind keine Kalkrückstände in der Dampfeinlassöffnung vorhanden. Reinigen Sie den Wassertank.

13.2 Servicedaten

Wenn Sie das Problem nicht selbst lösen können, wenden Sie sich an Ihren Händler oder einen autorisierten Kundendienst.

Die vom Kundendienst benötigten Daten finden Sie auf dem Typenschild. Das Typenschild befindet sich auf dem vorderen Rahmen des Garraums. Entfernen Sie das Typenschild nicht vom Garraum.

Wir empfehlen Ihnen, die Daten hier zu notieren:	
Modell (MOD.):
Produktnummer (PNC)
Seriennummer (S.N.)

14. ENERGIEEFFIZIENZ

14.1 Produktinformationen und Produktdatenblatt*

Herstellername	AEG
Modellidentifikation	BSB578270M 949494787 BSE578270M 949494772 BSS57807BM 949494790 BSS578270M 949494786
Energieeffizienzindex	81.2
Energieeffizienzklasse	A+
Energieverbrauch bei Standardbeladung, Ober-/Unterhitze	0.93 kWh/Programm
Energieverbrauch bei Standardbeladung, Umluft	0.69 kWh/Programm
Anzahl der Garräume	1

Wärmequelle	Strom	
Fassungsvermögen	72 l	
Backofentyp	Einbau-Backofen	
Gewicht	BSB578270M	33.7 kg
	BSE578270M	32.9 kg
	BSS57807BM	34.8 kg
	BSS578270M	33.8 kg

* Für die Europäische Union gemäß EU-Richtlinien 65/2014 und 66/2014.
Für die Republik Weißrussland gemäß STB 2478-2017, Anhang G; STB 2477-2017, Anlagen A und B.
Für die Ukraine gemäß 568/32020.

Die Energieeffizienzklasse gilt nicht für Russland.

EN 60350-1 - Elektrische Kochgeräte für den Hausgebrauch - Teil 1: Herde, Backöfen, Dampfgarer und Grillgeräte - Verfahren zur Messung der Gebrauchseigenschaften.

14.2 Energiesparen



Der Backofen verfügt über Funktionen, mit deren Hilfe Sie beim täglichen Kochen Energie sparen können.

Achten Sie darauf, dass die Backofentür während des Ofenbetriebs geschlossen ist. Die Backofentür darf während des Garvorgangs nicht zu oft geöffnet werden. Halten Sie die Türdichtung sauber und stellen Sie sicher, dass sie sich fest in der richtigen Position befindet. Verwenden Sie Kochgeschirr aus Metall, um mehr Energie zu sparen. Heizen Sie, wenn möglich, den Backofen nicht vor. Wenn Sie mehrere Speisen gleichzeitig zubereiten, halten Sie die Unterbrechungen beim Backen so kurz wie möglich.

Garen mit Heißluft

Nutzen Sie, wenn möglich, die Garfunktionen mit Heißluft, um Energie zu sparen.

Restwärme

Ventilator und Lampe funktionieren weiter. Sobald Sie den Backofen ausschalten, wird im Display die Restwärme angezeigt. Die Restwärme kann zum Warmhalten von Speisen genutzt werden.

Beträgt die Garzeit mehr als 30 Minuten, reduzieren Sie die Ofentemperatur 3 - 10 Min. vor Ablauf des Garvorgangs. Die Restwärme im Backofen wird weiterhin garen.

Nutzen Sie die Restwärme, um andere Speisen aufzuwärmen.

MENÜSTRUKTUR

Warmhalten von Speisen

Wählen Sie die niedrigste Temperatureinstellung, wenn Sie die Restwärme zum Warmhalten von Speisen nutzen möchten. Die Restwärmeanzeige oder Temperatur werden auf dem Display angezeigt.

Garen bei ausgeschalteter Backofenbeleuchtung

Schalten Sie die Lampe während des Garvorgangs aus. Schalten Sie sie nur ein, wenn Sie sie benötigen.

Feuchte Umluft



Diese Funktion soll während des Garvorgangs Energie sparen.







Bei Verwendung dieser Funktion schaltet sich die Lampe automatisch nach 30 Sekunden aus. Sie können die Lampe wieder einschalten, aber dadurch werden die erwarteten Energieeinsparungen reduziert.

15. MENÜSTRUKTUR

15.1 Menü

	≡ - Wählen Sie , um die Menü einzugeben.
---	--



Menü Struktur		
Koch-Assistent 	Reinigung 	Einstellungen 

Schritt 1	Schritt 2	Schritt 3	Schritt 4	Schritt 5
 ≡ 	 OK	 O1 - O15	 OK	
Wählen Sie Menü, Einstellungen.	Bestätigen Sie die Einstellung.	Wählen Sie die Einstellung.	Bestätigen Sie die Einstellung.	Stellen Sie den Wert ein und drücken Sie OK.

Einstellungen					
O1	Uhrzeit	Ändern	O2	Helligkeit	1 - 5
O3	Tastentöne	1 - Signalton 2 - Klicken 3 - Ausschalten	O4	Lautstärke	1 - 4

Einstellungen					
O5	Temperatursensor Aktion	1 - Alarm und Stopp 2 - Alarm	O6	Uptimer	Ein / Aus
O7	Backofenbeleuchtung	Ein / Aus	O8	Schnellaufheizung	Ein / Aus
O9	Erinnerungsfunktion Reinigen	Ein / Aus	O10	Wi-Fi	Ein / Aus
O11	Automatischer Fernbetrieb	Ein / Aus	O12	Netzwerk ignorieren	Ja / Nein
O13	DEMO	Aktivierungscode: 2468	O14	Softwareversion	Prüfen
O15	Gerät auf Werkseinstellungen zurücksetzen	Ja / Nein			

16. UMWELTTIPPS

Recyceln Sie Materialien mit dem Symbol . Entsorgen Sie die Verpackung in den entsprechenden Recyclingbehältern. Recyceln Sie zum Umwelt- und Gesundheitsschutz elektrische und elektronische Geräte. Entsorgen Sie Geräte mit diesem Symbol  nicht mit dem Hausmüll. Bringen Sie das Gerät zu Ihrer örtlichen Sammelstelle oder wenden Sie sich an Ihr Gemeindeamt.

CONTENTS

FOR PERFECT RESULTS

Thank you for choosing this AEG product. We have created it to give you impeccable performance for many years, with innovative technologies that help make life simpler – features you might not find on ordinary appliances. Please spend a few minutes reading to get the very best from it.

Visit our website to:



Get usage advice, brochures, trouble shooter, service and repair information:
www.aeg.com/support



Register your product for better service:
www.registeraeg.com



Buy Accessories, Consumables and Original spare parts for your appliance:
www.aeg.com/shop



For more recipes, hints, troubleshooting download **My AEG Kitchen** app.



CUSTOMER CARE AND SERVICE

Always use original spare parts.

When contacting our Authorised Service Centre, ensure that you have the following data available: Model, PNC, Serial Number.

The information can be found on the rating plate.

 Warning / Caution-Safety information

 General information and tips

 Environmental information

Subject to change without notice.

CONTENTS

1. SAFETY INFORMATION.....	50	2.8 Service.....	55
1.1 Children and vulnerable people safety.....	50	2.9 Disposal.....	56
1.2 General Safety.....	50	3. INSTALLATION.....	56
2. SAFETY INSTRUCTIONS.....	51	3.1 Building in.....	56
2.1 Installation.....	51	3.2 Securing the oven to the cabinet...	57
2.2 Electrical connection.....	52	4. PRODUCT DESCRIPTION.....	58
2.3 Use.....	53	4.1 General overview.....	58
2.4 Care and cleaning.....	54	4.2 Accessories.....	58
2.5 Pyrolytic cleaning.....	54	5. HOW TO TURN OVEN ON AND OFF.....	59
2.6 Steam Cooking.....	55	5.1 Retractable knobs.....	59
2.7 Internal lighting.....	55		

5.2 Control panel.....	59	11. HINTS AND TIPS.....	75
6. BEFORE FIRST USE.....	60	11.1 Moist Fan Baking.....	75
6.1 Initial cleaning.....	60	11.2 Moist Fan Baking - recommended accessories.....	77
6.2 Initial preheating.....	60	11.3 Cooking tables for test institutes..	77
6.3 Wireless connection 	61	12. CARE AND CLEANING.....	79
6.4 Software licences.....	62	12.1 Notes on cleaning.....	79
7. DAILY USE.....	62	12.2 How to remove: Shelf supports ...	80
7.1 How to set: Heating functions.....	62	12.3 How to use: Pyrolytic Cleaning...	80
7.2 Heating functions.....	63	12.4 Cleaning Reminder.....	81
7.3 Notes on: Moist Fan Baking.....	64	12.5 How to clean: Water tank.....	81
7.4 Water tank.....	64	12.6 How to remove and install: Door..	82
7.5 How to set: Assisted Cooking.....	65	12.7 How to replace: Lamp.....	84
7.6 Assisted Cooking with recipes.....	65	13. TROUBLESHOOTING.....	85
8. CLOCK FUNCTIONS.....	70	13.1 What to do if.....	85
8.1 Clock functions.....	70	13.2 Service data.....	87
8.2 How to set: Clock functions.....	70	14. ENERGY EFFICIENCY.....	87
9. HOW TO USE: ACCESSORIES.....	72	14.1 Product Information and Product Information Sheet*.....	87
9.1 Inserting accessories.....	72	14.2 Energy saving.....	88
9.2 Food Sensor.....	73	15. MENU STRUCTURE.....	89
10. ADDITIONAL FUNCTIONS.....	74	15.1 Menu.....	89
10.1 Lock.....	74	16. ENVIRONMENTAL CONCERNS.....	90
10.2 Automatic switch-off.....	75		
10.3 Cooling fan.....	75		



1. ⚠ SAFETY INFORMATION

Before the installation and use of the appliance, carefully read the supplied instructions. The manufacturer is not responsible for any injuries or damage that are the result of incorrect installation or usage. Always keep the instructions in a safe and accessible location for future reference.

1.1 Children and vulnerable people safety

- This appliance can be used by children aged from 8 years and above and persons with reduced physical, sensory or mental capabilities or lack of experience and knowledge if they have been given supervision or instruction concerning the use of the appliance in a safe way and understand the hazards involved. Children of less than 8 years of age and persons with very extensive and complex disabilities shall be kept away from the appliance unless continuously supervised.
- Children should be supervised to ensure that they do not play with the appliance and mobile devices with My AEG Kitchen.
- Keep all packaging away from children and dispose of it appropriately.
- **WARNING:** Keep children and pets away from the appliance when it operates or when it cools down. Accessible parts become hot during use.
- If the appliance has a child safety device, it should be activated.
- Children shall not carry out cleaning and user maintenance of the appliance without supervision.

1.2 General Safety

- Only a qualified person must install this appliance and replace the cable.

- Do not use the appliance before installing it in the built-in structure.
- Disconnect the appliance from the power supply before carrying out any maintenance.
- If the mains power supply cable is damaged, it must be replaced by the manufacturer, its Authorised Service Centre or similarly qualified persons to avoid an electrical hazard.
- **WARNING:** Ensure that the appliance is switched off before replacing the lamp to avoid the possibility of electric shock.
- **WARNING:** The appliance and its accessible parts become hot during use. Care should be taken to avoid touching heating elements.
- Always use oven gloves to remove or put in accessories or ovenware.
- Use only the food sensor (core temperature sensor) recommended for this appliance.
- To remove the shelf supports first pull the front of the shelf support and then the rear end away from the side walls. Install the shelf supports in the opposite sequence.
- Do not use a steam cleaner to clean the appliance.
- Do not use harsh abrasive cleaners or sharp metal scrapers to clean the glass door since they can scratch the surface, which may result in shattering of the glass.
- Excessive spillage must be removed before the pyrolytic cleaning. Remove all parts from the oven.

2. SAFETY INSTRUCTIONS

2.1 Installation

**WARNING!**

Only a qualified person must install this appliance.

- Remove all the packaging.
- Do not install or use a damaged appliance.
- Follow the installation instructions supplied with the appliance.
- Always take care when moving the appliance as it is heavy. Always use safety gloves and enclosed footwear.
- Do not pull the appliance by the handle.

SAFETY INSTRUCTIONS

- Install the appliance in a safe and suitable place that meets installation requirements.
- Keep the minimum distance from other appliances and units.
- Before mounting the appliance, check if the oven door opens without restraint.
- The appliance is equipped with an electric cooling system. It must be operated with the electric power supply.

Cabinet minimum height (Cabinet under the work-top minimum height)	590 (600) mm
Cabinet width	560 mm
Cabinet depth	550 (550) mm
Height of the front of the appliance	594 mm
Height of the back of the appliance	576 mm
Width of the front of the appliance	595 mm
Width of the back of the appliance	559 mm
Depth of the appliance	569 mm
Built in depth of the appliance	548 mm
Depth with open door	1022 mm
Ventilation opening minimum size. Opening placed on the bottom rear side	560x20 mm
Mains supply cable length. Cable is placed in the right corner of the back side	1500 mm
Mounting screws	4x25 mm

2.2 Electrical connection



WARNING!

Risk of fire and electric shock.

- All electrical connections should be made by a qualified electrician.
- The appliance must be earthed.
- Make sure that the parameters on the rating plate are compatible with the electrical ratings of the mains power supply.
- Always use a correctly installed shockproof socket.
- Do not use multi-plug adapters and extension cables.
- Make sure not to cause damage to the mains plug and to the mains cable. Should the mains cable need to be replaced, this must be carried out by our Authorised Service Centre.

- Do not let mains cables touch or come near the appliance door or the niche below the appliance, especially when it operates or the door is hot.
- The shock protection of live and insulated parts must be fastened in such a way that it cannot be removed without tools.
- Connect the mains plug to the mains socket only at the end of the installation. Make sure that there is access to the mains plug after the installation.
- If the mains socket is loose, do not connect the mains plug.
- Do not pull the mains cable to disconnect the appliance. Always pull the mains plug.
- Use only correct isolation devices: line protecting cut-outs, fuses (screw type fuses removed from the holder), earth leakage trips and contactors.
- The electrical installation must have an isolation device which lets you disconnect the appliance from the mains at all poles. The isolation device must have a contact opening width of minimum 3 mm.
- Fully close the appliance door before you connect the mains plug to the mains socket.
- This appliance is supplied with a main plug and a main cable.

Cable types applicable for installation or replacement for Europe:

H07 RN-F, H05 RN-F, H05 RRF, H05 VV-F, H05 V2V2-F (T90), H05 BB-F

For the section of the cable refer to the total power on the rating plate. You can also refer to the table:

Total power (W)	Section of the cable (mm ²)
maximum 1380	3 x 0.75
maximum 2300	3 x 1
maximum 3680	3 x 1.5

The earth cord (green / yellow cable) must be 2 cm longer than phase and neutral cables (blue and brown cables).

2.3 Use



WARNING!

Risk of injury, burns and electric shock or explosion.

- This appliance is for household (indoors) use only.
- Do not change the specification of this appliance.
- Make sure that the ventilation openings are not blocked.
- Do not let the appliance stay unattended during operation.
- Deactivate the appliance after each use.
- Be careful when you open the appliance door while the appliance is in operation. Hot air can release.
- Do not operate the appliance with wet hands or when it has contact with water.
- Do not apply pressure on the open door.
- Do not use the appliance as a work surface or as a storage surface.

SAFETY INSTRUCTIONS

- Open the appliance door carefully. The use of ingredients with alcohol can cause a mixture of alcohol and air.
- Do not let sparks or open flames to come in contact with the appliance when you open the door.
- Do not put flammable products or items that are wet with flammable products in, near or on the appliance.
- Do not share your Wi-Fi password.



WARNING!

Risk of damage to the appliance.

- To prevent damage or discoloration to the enamel:
 - do not put ovenware or other objects in the appliance directly on the bottom.
 - do not put aluminium foil directly on the bottom of cavity of the appliance.
 - do not put water directly into the hot appliance.
 - do not keep moist dishes and food in the appliance after you finish the cooking.
 - be careful when you remove or install the accessories.
- Discoloration of the enamel or stainless steel has no effect on the performance of the appliance.
- Use a deep pan for moist cakes. Fruit juices cause stains that can be permanent.
- This appliance is for cooking purposes only. It must not be used for other purposes, for example room heating.
- Always cook with the oven door closed.
- If the appliance is installed behind a furniture panel (e.g. a door) make sure the door is never closed when the appliance operates. Heat and moisture can build up behind a closed furniture panel and cause subsequent damage to the appliance, the housing unit or the floor. Do not close the furniture panel until the appliance has cooled down completely after use.

2.4 Care and cleaning



WARNING!

Risk of injury, fire, or damage to the appliance.

- Before maintenance, deactivate the appliance and disconnect the mains plug from the mains socket.
- Make sure the appliance is cold. There is the risk that the glass panels can break.
- Replace immediately the door glass panels when they are damaged. Contact the Authorised Service Centre.
- Be careful when you remove the door from the appliance. The door is heavy!
- Clean regularly the appliance to prevent the deterioration of the surface material.
- Clean the appliance with a moist soft cloth. Use only neutral detergents. Do not use abrasive products, abrasive cleaning pads, solvents or metal objects.
- If you use an oven spray, follow the safety instructions on its packaging.

2.5 Pyrolytic cleaning



WARNING!

Risk of Injury / Fires / Chemical Emissions (Fumes) in Pyrolytic Mode.

- Before carrying out a Pyrolytic self-cleaning function or the First Use please remove from the oven cavity:
 - any excess food residues, oil or grease spills / deposits.

- any removable objects (including shelves, side rails etc., provided with the product) particularly any non-stick pots, pans, trays, utensils etc.
- Read carefully all the instructions for Pyrolytic cleaning.
- Keep children away from the appliance while the Pyrolytic cleaning operates. The appliance becomes very hot and hot air is released from the front cooling vents.
- Pyrolytic cleaning is a high temperature operation that can release fumes from cooking residues and construction materials, as such consumers are strongly advised to:
 - provide good ventilation during and after each Pyrolytic cleaning.
 - provide good ventilation during and after the first use at maximum temperature operation.
- Unlike all humans, some birds and reptiles can be extremely sensitive to potential fumes emitted during the cleaning process of all Pyrolytic Ovens.
 - Remove any pets (especially birds) from the vicinity of the appliance location during and after the Pyrolytic cleaning and first use maximum temperature operation to a well ventilated area.
- Small pets can also be highly sensitive to the localized temperature changes in the vicinity of all Pyrolytic Ovens when the Pyrolytic self cleaning program is in operation.
- Non-stick surfaces on pots, pans, trays, utensils etc., can be damaged by the high temperature Pyrolytic cleaning operation of all Pyrolytic Ovens and can be also a source for low level harmful fumes.
- Fumes released from all Pyrolytic Ovens / Cooking Residues as described are not harmful to humans, including children, or persons with medical conditions.

2.6 Steam Cooking



WARNING!

Risk of burns and damage to the appliance.

- Released Steam can cause burns:
 - Do not open the appliance door during the steam cooking operation.
 - Open the appliance door with care after the steam cooking operation.

2.7 Internal lighting



WARNING!

Risk of electric shock.

- Concerning the lamp(s) inside this product and spare part lamps sold separately: These lamps are intended to withstand extreme physical conditions in household appliances, such as temperature, vibration, humidity, or are intended to signal information about the operational status of the appliance. They are not intended to be used in other applications and are not suitable for household room illumination.
- Use only lamps with the same specifications.

2.8 Service

- To repair the appliance contact the Authorised Service Centre.
- Use original spare parts only.

INSTALLATION

2.9 Disposal



WARNING!

Risk of injury or suffocation.

- Contact your municipal authority for information on how to dispose of the appliance.
- Disconnect the appliance from the mains supply.
- Cut off the mains electrical cable close to the appliance and dispose of it.
- Remove the door catch to prevent children or pets from becoming trapped in the appliance.

3. INSTALLATION



WARNING!

Refer to Safety chapters.

3.1 Building in



YouTube

www.youtube.com/electrolux
www.youtube.com/aeg

How to install your AEG/Electrolux
Oven - Column installation

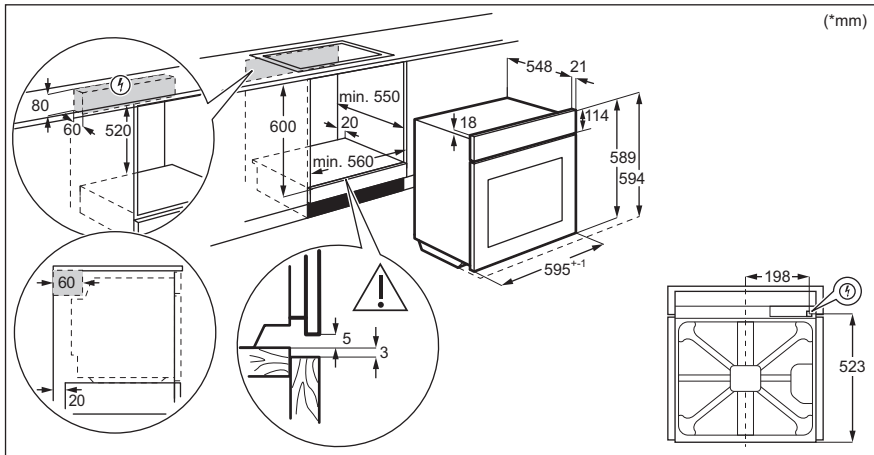

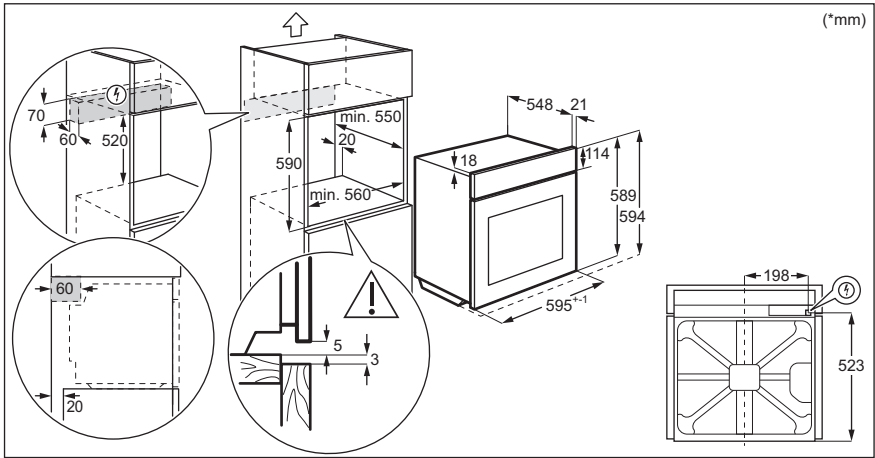

3.2 Securing the oven to the cabinet

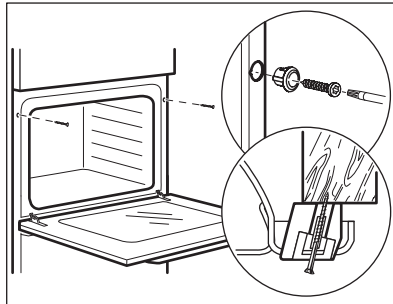

4. PRODUCT DESCRIPTION

4.1 General overview

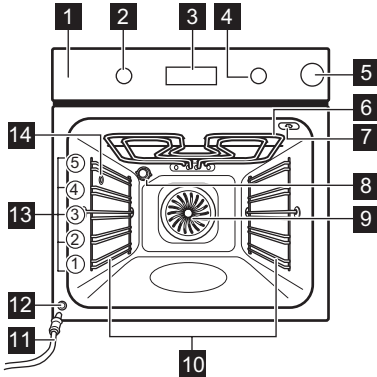

- 1** Control panel
- 2** Knob for the heating functions
- 3** Display
- 4** Control knob
- 5** Water drawer
- 6** Heating element
- 7** Socket for the food sensor
- 8** Lamp
- 9** Fan
- 10** Shelf support, removable
- 11** Draining pipe
- 12** Water outlet valve
- 13** Shelf positions
- 14** Steam inlet

4.2 Accessories







- **Wire shelf**
For cookware, cake tins, roasts.
- **Baking tray**
For cakes and biscuits.
- **Grill- / Roasting pan**
To bake and roast or as pan to collect fat.
- **Food sensor**
To measure how far the food is cooked.

5. HOW TO TURN OVEN ON AND OFF





5.1 Retractable knobs

To use the appliance press the knob. The knob comes out.

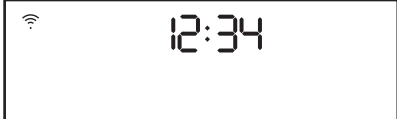
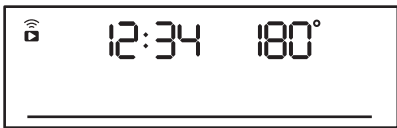
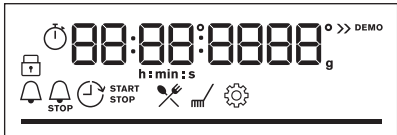









5.2 Control panel

Control panel sensor fields					Press	Turn the knob
 Timer	 Fast Heat Up	 Light	 Food Sensor	OK		
Select a heating function to turn on the oven.						
Turn the knob for the heating functions to the off position to turn the oven off.						

	When the knob for the heating functions is in the off position, the display goes to standby.
	When you cook, the display shows the set temperature, time of day and other available options.
	The display with the maximum number of functions set.

Display indicators				
 Lock	 Assisted Cooking	 Cleaning	 Settings	 Fast Heat Up





BEFORE FIRST USE

Timer indicators:				
Wi-Fi indicator - flashes when the oven can be connected to Wi-Fi.			Remote operation indicator - the oven can be controlled remotely.	
 Wi-Fi connection is turned on.			 Remote operation is turned on.	
Progress bar - for temperature or time.				
Water tank indicators				
				
Food sensor indicator				

6. BEFORE FIRST USE



	WARNING! Refer to Safety chapters.
--	--

6.1 Initial cleaning

Before the first use clean the empty oven and set the time:			
			 00:00 Set the time. Press OK .

6.2 Initial preheating

Preheat the empty oven before the first use.	
Step 1	Remove all accessories and removable shelf supports from the oven.

Preheat the empty oven before the first use.	
Step 2	Set the maximum temperature for the function:  Let the oven operate for 1 h.
Step 3	Set the maximum temperature for the function:  Let the oven operate for 15 min.
 The oven can emit an odour and smoke during preheating. Make sure that the room is ventilated.	

6.3 Wireless connection

To connect the oven you need:

- Wireless network with the Internet connection.
- Mobile device connected to your wireless network.

Step 1	Download the mobile app My AEG Kitchen and follow the instructions for the next steps.
Step 2	Turn the knob to select:  .

Frequency	2.4 GHz WLAN	5 GHz WLAN
	2400 - 2483.5 MHz	5150 - 5350 MHz 5470 - 5725 MHz
Protocol	IEEE 802.11b DSSS, 802.11g/n OFDM	IEEE 802.11 a/n OFDM
Max Power	EIRP < 20 dBm (100 mW)	EIRP < 23 dBm (200 mW)
Wi-Fi module	NIU5-50	

Frequency Bluetooth	2400 - 2483.5 MHz
Protocol	LE: DSSS
Max Power	EIRP < 4 dBm (2.5 mW)

Countries covered by the provision of Directive 2014/53/EU: Belgium, Bulgaria, Czech Republic, Denmark, Germany, Estonia, Ireland, Greece, Spain, France, Croatia, Italy, Cyprus, Latvia, Lithuania, Luxemburg, Hungary, Malta, Netherlands, Northern Ireland, Austria, Poland,

DAILY USE

Portugal, Romania, Slovenia, Slovakia, Finland, Sweden, Norway, Iceland, Liechtenstein, Switzerland, Turkey.

6.4 Software licences

The software in this product contains components that are based on free and open source software. AEG gratefully acknowledges the contributions of the open software and robotics communities to the development project.

To access the source code of these free and open source software components whose license conditions require publishing, and to see their full copyright information and applicable license terms, please visit: <http://aeg.opensoftwarerepository.com> (folder NIU5).

7. DAILY USE



WARNING!

Refer to Safety chapters.









7.1 How to set: Heating functions

Start cooking	
Step 1	Step 2
Set a heating function.	Set the temperature.

Steam cooking				
Step 1	Step 2	Step 3	Step 4	Step 5
Press the cover of the water drawer to open it.	Fill the water drawer with 900 ml of water.	Push the water drawer to its initial position.	Set the steam heating function.	Set the temperature.

7.2 Heating functions

Standard heating functions

Heating function	Application
 <p>True Fan Cooking</p>	To bake on up to three shelf positions at the same time and to dry food. Set the temperature 20 - 40 °C lower than for Conventional Cooking.
 <p>Conventional Cooking</p>	To bake and roast food on one shelf position.
 <p>Humidity Low</p>	The function is suitable for meat, poultry, oven dishes and casseroles. Thanks to the combination of steam and heat, meat gets a tender and juicy texture along with a crusty surface.
 <p>Pizza Function</p>	To bake pizza. To make intensive browning and a crispy bottom.
 <p>Bottom Heat</p>	To bake cakes with crispy bottom and to preserve food.
 <p>Frozen Foods</p>	To make convenience food (e.g., french fries, potato wedges or spring rolls) crispy.
 <p>Moist Fan Baking</p>	This function is designed to save energy during cooking. When you use this function, the temperature in the cavity may differ from the set temperature. The residual heat is used. The heating power may be reduced. For more information refer to "Daily Use" chapter, Notes on: Moist Fan Baking.
 <p>Grill</p>	To grill thin pieces of food and to toast bread.
 <p>Turbo Grilling</p>	To roast large meat joints or poultry with bones on one shelf position. To make gratins and to brown.

Heating function	Application
 Menu	To enter the Menu: Assisted Cooking, Cleaning, Settings.

7.3 Notes on: Moist Fan Baking



This function was used to comply with the energy efficiency class and ecodesign requirements according to EU 65/2014 and EU 66/2014. Tests according to EN 60350-1.

The oven door should be closed during cooking so that the function is not interrupted and the oven operates with the highest energy efficiency possible.

When you use this function the lamp automatically turns off after 30 sec.

For the cooking instructions refer to "Hints and tips" chapter, Moist Fan Baking. For general energy saving recommendations refer to "Energy Efficiency" chapter, Energy Saving.

7.4 Water tank

Water tank indicator	
	The tank is full.
	The tank is half full.
	The tank is empty. Refill the tank.
If you put too much water into the tank, the safety outlet moves the excess water to the bottom of the cavity. Remove the water with a sponge.	



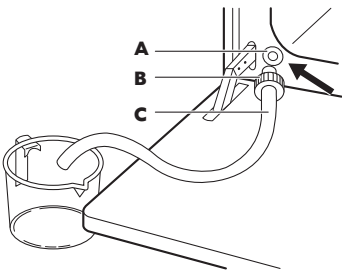

Emptying the water tank	
Step 1	Turn off the oven, leave it with the door open and wait until the oven is cold.
Step 2	Connect the draining pipe (C) to the outlet valve (A) through the connector (B).
Step 3	Keep the end of the pipe below the level of A and push B repeatedly to collect remaining water.
Step 4	Detach the C and B and dry the oven with a soft sponge.







7.5 How to set: Assisted Cooking

Every dish in this submenu has a recommended function and temperature. You can adjust the time and the temperature during cooking.

For some of the dishes you can also cook with:	The degree to which a dish is cooked:
<ul style="list-style-type: none"> Food Sensor 	<ul style="list-style-type: none"> Rare Medium Well done





















Assisted Cooking - use it to prepare a dish quickly with default settings:			
Step 1	Step 2	Step 3	Step 4
			
Enter the menu.	Select Assisted Cooking. Press OK .	Select the dish. Press OK .	Insert the dish to the oven. Confirm setting.

7.6 Assisted Cooking with recipes























Legend	
	Food sensor available. Place the Food sensor in the thickest part of the dish. The oven turns off when the set Food sensor temperature is reached.
	Add water to the tank.
	Preheat the oven before you start cooking.
	Shelf level.





















When the function ends check if the food is ready.

	Dish	Weight	Shelf level / Accessory	Duration time
Beef 🍖				
P1	Roast Beef, rare	1 - 1,5 kg; 4 - 5 cm thick pieces	🔪 📦 2; baking tray Fry the meat for a few minutes on a hot pan. Insert to the oven.	~ 40 min
P2	Roast Beef, medium			~ 50 min
P3	Roast Beef, well done			~ 60 min
P4	Steak, medium	180 - 220 g per piece; 3 cm thick slices	🔪 📦 3; roasting dish on wire shelf Fry the meat for a few minutes on a hot pan. Insert to the oven.	~ 15 min
P5	Beef roast / braised (prime rib, top round, thick flank)	1,5 - 2 kg	🔪 📦 2; roasting dish on wire shelf Fry the meat for a few minutes on a hot pan. Add liquid. Insert to the oven.	~ 120 min
P6	Roast Beef, rare (slow cooking)	1 - 1,5 kg; 4 - 5 cm thick pieces	🔪 📦 2; baking tray Use your favourite spices or simply salt and fresh ground pepper. Fry the meat for a few minutes on a hot pan. Insert to the oven.	~ 75 min
P7	Roast Beef, medium (slow cooking)			~ 85 min
P8	Roast Beef, well done (slow cooking)			~ 130 min
P9	Fillet, rare (slow cooking)	0,5 - 1,5 kg; 5 - 6 cm thick pieces	🔪 📦 2; baking tray Use your favourite spices or simply salt and fresh ground pepper. Fry the meat for a few minutes on a hot pan. Insert to the oven.	~ 75 min
P10	Fillet, medium (slow cooking)			~ 90 min
P11	Fillet, done (slow cooking)			~ 120 min
Veal 🍖				









	Dish	Weight	Shelf level / Accessory	Duration time
P12	Veal roast (e.g. shoulder)	0,8 - 1,5 kg; 4 cm thick pieces	  2; roasting dish on wire shelf Use your favourite spices. Add liquid. Roast covered.	~ 80 min
Pork  				
P13	Pork roast neck or shoulder	1,5 - 2 kg	   1; roasting dish on wire shelf Turn the meat after half of the cooking time.	~ 165 min
P14	Pulled pork LTC	1,5 - 2 kg	  2; baking tray Use your favourite spices. Turn the meat after half of the cooking time to get an even browning.	~ 215 min
P15	Loin, fresh	1 - 1,5 kg; 5 - 6 cm thick pieces	  2; roasting dish on wire shelf Use your favourite spices.	~ 55 min
P16	Spare Ribs	2 - 3 kg; use raw, 2 - 3 cm thin spare ribs	 3; deep pan Add liquid to cover the bottom of a dish. Turn the meat after half of the cooking time.	90 min
Lamb 				
P17	Lamb leg with bones	1,5 - 2 kg; 7 - 9 cm thick pieces	  2; roasting dish on baking tray Add liquid. Turn the meat after half of the cooking time.	~ 130 min
Poultry 				
P18	Whole chicken	1 - 1,5 kg; fresh	  2; casserole dish on baking tray Use your favourite spices. Turn the chicken after half of the cooking time to get an even browning.	~ 60 min
P19	Half chicken	0,5 - 0,8 kg	  3; baking tray Use your favourite spices.	~ 40 min

DAILY USE

	Dish	Weight	Shelf level / Accessory	Duration time
P20	Chicken breast	180 - 200 g per piece	  2; casserole dish on wire shelf Use your favourite spices. Fry the meat for a few minutes on a hot pan.	~ 25 min
P21	Chicken legs, fresh	-	  3; baking tray If you marinated chicken legs first, set lower temperature and cook them longer.	~ 30 min
P22	Duck, whole	2 - 3 kg	  2; roasting dish on wire shelf Use your favourite spices. Put the meat on roasting dish. Turn the duck after half of the cooking time.	~ 100 min
P23	Goose, whole	4 - 5 kg	  2; deep pan Use your favourite spices. Put the meat on deep baking tray. Turn the goose after half of the cooking time.	~ 110 min
Other 				
P24	Meat loaf	1 kg	  2; wire shelf Use your favourite spices.	~ 60 min
 Fish				
P25	Whole fish, grilled	0,5 - 1 kg per fish	  2; baking tray Fill the fish with butter and use your favourite spices and herbs.	~ 30 min
P26	Fish fillet	-	  3; casserole dish on wire shelf Use your favourite spices.	35 min
Sweet baking / desserts   				
P27	Cheesecake	-	 2;  28 cm springform tin on wire shelf	90 min
P28	Apple cake	-	 3; baking tray	45 min





	Dish	Weight	Shelf level / Accessory	Duration time
P29	Apple tart	-	 2; pie form on wire shelf	40 min
P30	Apple pie	-	 1;  22 cm pie form on wire shelf	60 min
P31	Brownies	2 kg	 3; deep pan	30 min
P32	Chocolate muffins	-	 3; muffin tray on wire shelf	25 min
P33	Loaf cake	-	 2; loaf pan on wire shelf	50 min
Vegetable / Side dishes   				
P34	Baked potatoes	1 kg	 2; baking tray Put the whole potatoes with skin on baking tray.	50 min
P35	Wedges	1 kg	 3; baking tray lined with baking paper Use your favourite spices. Cut potatoes into pieces.	35 min
P36	Grilled mixed vegetables	1 - 1,5 kg	 3; baking tray lined with baking paper Use your favourite spices. Cut the vegetables into pieces.	30 min
P37	Croquets, frozen	0,5 kg	 3; baking tray	25 min
P38	Pommes, frozen	0,75 kg	 3; baking tray	25 min
Gratins, bread and pizza   				
P39	Lasagna / Noodle casserole	1 - 1,5 kg	  2; casserole dish on wire shelf	55 min
P40	Potato gratin	1 - 1,5 kg	  1; casserole dish on wire shelf	60 min

CLOCK FUNCTIONS

	Dish	Weight	Shelf level / Accessory	Duration time
P41	Pizza fresh, thin	-	  2; baking tray lined with baking paper	35 min
P42	Pizza fresh, thick	-	  2; baking tray lined with baking paper	25 min
P43	Quiche	-	 2; baking tin on wire shelf	45 min
P44	Baguette / Ciabatta / White bread	0.8 kg	  2; baking tray lined with baking paper More time needed for white bread.	50 min
P45	All grain / rye / dark bread all grain in loaf pan	1 kg	  2; baking tray lined with baking paper / wire shelf	60 min

8. CLOCK FUNCTIONS



8.1 Clock functions

Clock Function	Application
	Minute minder. When the timer ends, the signal sounds.
	Cooking time. When the timer ends, the signal sounds and the heating function stops.
	Time Delay. To postpone the start and / or end of cooking.
	Uptimer. Maximum is 23 h 59 min. This function has no effect on the operation of the oven. To turn on and off the Uptimer select: Menu, Settings.







8.2 How to set: Clock functions

How to set: Time of day		
Step 1	Step 2	Step 3







How to set: Time of day

		
To change the time of day enter the menu and select Settings, Time of day.	Set the clock.	Press: OK.











How to set: Minute minder

Step 1	The display shows: 0:00 	Step 2	Step 3
			
Press: 		Set the Minute minder	Press: OK.
 Timer starts counting down immediately.			

How to set: Cooking time

Step 1	Step 2	The display shows: 0:00  STOP	Step 3	Step 4
				
Choose a heating function and set the temperature.	Press repeatedly: 		Set the cooking time.	Press: OK.
 Timer starts counting down immediately.				

HOW TO USE: ACCESSORIES

How to set: Time Delay							
Step 1	Step 2		Step 3	Step 4		Step 5	Step 6
		The display shows: the time of day  START			The display shows: ---  STOP		
Select the heating function.	Press repeatedly: 		Set the start time.	Press: OK.		Set the end time.	Press: OK.
 Timer starts counting down at a set start time.							

9. HOW TO USE: ACCESSORIES

9.1 Inserting accessories

A small indentation at the top increases safety. The indentations are also anti-tip devices. The high rim around the shelf prevents cookware from slipping of the shelf.

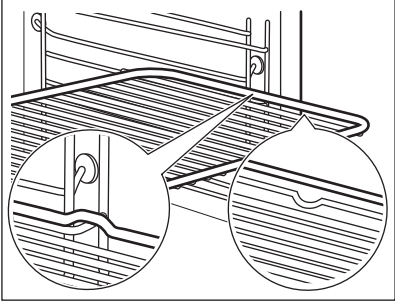
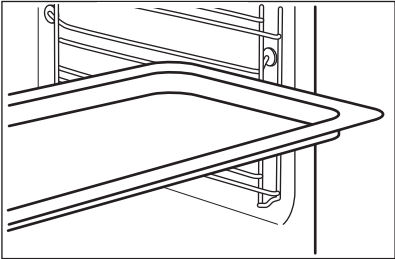
<p>Wire shelf: Push the shelf between the guide bars of the shelf support and make sure that the feet point down.</p>	
<p>Baking tray / Deep pan: Push the tray between the guide bars of the shelf support.</p>	

Wire shelf, Baking tray / Deep pan:
Push the tray between the guide bars of the shelf support and the wire shelf on the guide bars above.

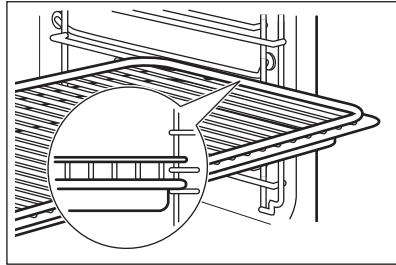

9.2 Food Sensor

Food Sensor- measures the temperature inside the food.

There are two temperatures to be set:



The oven temperature.



The core temperature.

For the best cooking results:

Ingredients should be at room temperature.



Do not use it for liquid dishes.

During cooking it must remain in the dish.

How to use: Food Sensor



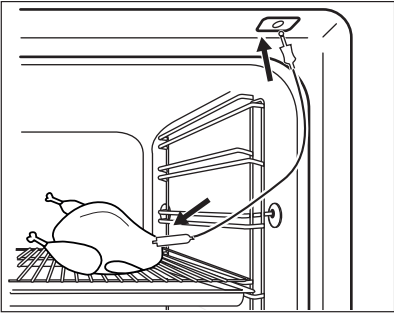
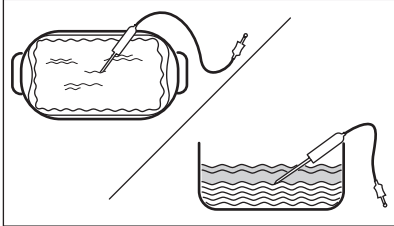

Step 1	Turn on the oven.
Step 2	Set a heating function and, if necessary, the oven temperature.
Step 3	Insert: Food Sensor.
Meat, poultry and fish	Casserole
Insert the tip of Food Sensor into the centre of meat, fish, in the thickest part if possible. Make sure that at least 3/4 of Food Sensor is inside of the dish.	Insert the tip of Food Sensor exactly in the centre of the casserole. Food Sensor should be stabilized in one place during baking. Use a solid ingredient to achieve that. Use the rim of the baking dish to support the silicone handle of Food Sensor. The tip of Food Sensor should not touch the bottom of a baking dish.

ADDITIONAL FUNCTIONS

	
Step 4	Plug Food Sensor into the socket at the front of the oven. The display shows the current temperature of: Food Sensor.
Step 5	 - press to set the core temperature of the sensor.
Step 6	OK - press to confirm. When food reaches the set temperature, the signal sounds. You can choose to stop or to continue cooking to make sure the food is well done.
Step 7	Remove Food Sensor plug from the socket and remove the dish from the oven. <div style="border: 1px solid black; padding: 5px; margin-top: 10px;">  <p>WARNING! There is a risk of burns as Food Sensor becomes hot. Be careful when you unplug it and remove it from the food.</p> </div>



10. ADDITIONAL FUNCTIONS

10.1 Lock

This function prevents an accidental change of the oven function.		
Turn it on when the oven works - the set cooking continues, the control panel is locked. Turn it on when the oven is off - the oven cannot be turned on, the control panel is locked.		
	 OK - press and hold to turn on the function. A signal sounds.	 OK - press and hold to turn it off.
 3 x  - flashes when the lock is turned on.		

10.2 Automatic switch-off

For safety reasons the oven turns off after some time, if a heating function works and you do not change any settings.

 (°C)	 (h)
30 - 115	12.5
120 - 195	8.5
200 - 245	5.5
250 - maximum	3

The Automatic switch-off does not work with the functions: Light, Food sensor, Time Delay.





10.3 Cooling fan

When the oven operates, the cooling fan turns on automatically to keep the surfaces of the oven cool. If you turn off the oven, the cooling fan can continue to operate until the oven cools down.





11. HINTS AND TIPS





11.1 Moist Fan Baking

For the best results follow suggestions listed in the table below.

		 (°C)		 (min)
Sweet rolls, 16 pieces	baking tray or dripping pan	180	2	20 - 30
Rolls, 9 pieces	baking tray or dripping pan	180	2	30 - 40
Pizza, frozen, 0.35 kg	wire shelf	220	2	10 - 15
Swiss Roll	baking tray or dripping pan	170	2	25 - 35
Brownie	baking tray or dripping pan	175	3	25 - 30



HINTS AND TIPS

		 (°C)		 (min)
Soufflè, 6 pieces	ceramic ramekins on wire shelf	200	3	25 - 30
Sponge flan base	flan base tin on wire shelf	180	2	15 - 25
Victoria sandwich	baking dish on wire shelf	170	2	40 - 50
Poached fish, 0.3 kg	baking tray or dripping pan	180	3	20 - 25
Whole fish, 0.2 kg	baking tray or dripping pan	180	3	25 - 35
Fish fillet, 0.3 kg	pizza pan on wire shelf	180	3	25 - 30
Poached meat, 0.25 kg	baking tray or dripping pan	200	3	35 - 45
Shashlik, 0.5 kg	baking tray or dripping pan	200	3	25 - 30
Cookies, 16 pieces	baking tray or dripping pan	180	2	20 - 30
Macaroons, 24 pieces	baking tray or dripping pan	180	2	25 - 35
Muffins, 12 pieces	baking tray or dripping pan	170	2	30 - 40
Savory pastry, 20 pieces	baking tray or dripping pan	180	2	25 - 30
Short crust biscuits, 20 pieces	baking tray or dripping pan	150	2	25 - 35
Tartlets, 8 pieces	baking tray or dripping pan	170	2	20 - 30
Vegetables, poached, 0.4 kg	baking tray or dripping pan	180	3	35 - 45

		 (°C)		 (min)
Vegetarian omelette	pizza pan on wire shelf	200	3	25 - 30
Mediterranean vegetables, 0.7 kg	baking tray or dripping pan	180	4	25 - 30

11.2 Moist Fan Baking - recommended accessories

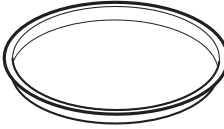
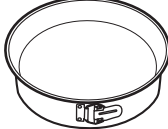





Use the dark and non-reflective tins and containers. They have better heat absorption than the light colour and reflective dishes.

			
Pizza pan	Baking dish	Ramekins	Flan base tin
Dark, non-reflective 28 cm diameter	Dark, non-reflective 26 cm diameter	Ceramic 8 cm diameter, 5 cm height	Dark, non-reflective 28 cm diameter







11.3 Cooking tables for test institutes

Information for test institutes







Tests according to IEC 60350-1.

				 (°C)	 (min)	
Small cakes, 20 per tray	Conventional Cooking	Baking tray	3	170	20 - 30	-
Small cakes, 20 per tray	True Fan Cooking	Baking tray	3	150 - 160	20 - 35	-

HINTS AND TIPS

				 (°C)	 (min)	
Small cakes, 20 per tray	True Fan Cooking	Baking tray	2 and 4	150 - 160	20 - 35	-
Apple pie, 2 tins Ø20 cm	Conventional Cooking	Wire shelf	2	180	70 - 90	-
Apple pie, 2 tins Ø20 cm	True Fan Cooking	Wire shelf	2	160	70 - 90	-
Sponge cake, cake mould Ø26 cm	Conventional Cooking	Wire shelf	2	170	40 - 50	Preheat the oven for 10 minutes.
Sponge cake, cake mould Ø26 cm	True Fan Cooking	Wire shelf	2	160	40 - 50	Preheat the oven for 10 minutes.
Sponge cake, cake mould Ø26 cm	True Fan Cooking	Wire shelf	2 and 4	160	40 - 60	Preheat the oven for 10 minutes.
Short bread	True Fan Cooking	Baking tray	3	140 - 150	20 - 40	-
Short bread	True Fan Cooking	Baking tray	2 and 4	140 - 150	25 - 45	-
Short bread	Conventional Cooking	Baking tray	3	140 - 150	25 - 45	-

CARE AND CLEANING

				 (°C)	 (min)	
Toast, 4 - 6 pieces	Grill	Wire shelf	4	max.	2 - 3 minutes first side; 2 - 3 minutes second side	Preheat the oven for 3 minutes.
Beef burger, 6 pieces, 0.6 kg	Grill	Wire shelf and dripping pan	4	max.	20 - 30	Put the wire shelf on the fourth level and the dripping pan on the third level of the oven. Turn the food half-way through the cooking time. Preheat the oven for 3 minutes.



12. CARE AND CLEANING



WARNING!

Refer to Safety chapters.

12.1 Notes on cleaning

 <p>Cleaning Agents</p>	Clean the front of the oven with a soft cloth with warm water and a mild detergent.
	Use a cleaning solution to clean metal surfaces.
	Clean stains with a mild detergent.
 <p>Everyday Use</p>	Clean the cavity after each use. Fat accumulation or other residue may cause fire.
	Moisture can condense in the oven or on the door glass panels. To decrease the condensation, let the oven work for 10 minutes before cooking. Do not store the food in the oven for longer than 20 minutes. Dry the cavity with a soft cloth after each use.

CARE AND CLEANING

 <p>Accessories</p>	<p>Clean all accessories after each use and let them dry. Use a soft cloth with warm water and a mild detergent. Do not clean the accessories in a dishwasher.</p>
	<p>Do not clean the non-stick accessories using abrasive cleaner or sharp-edged objects.</p>

12.2 How to remove: Shelf supports

Remove the shelf supports to clean the oven.

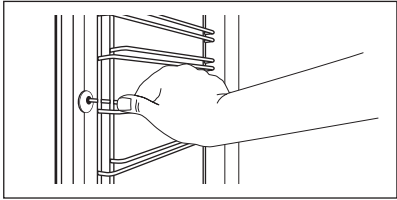
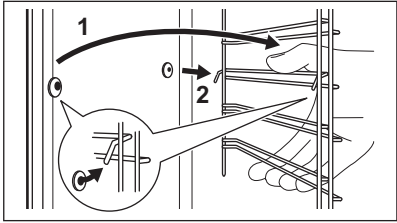
Step 1	Turn off the oven and wait until it is cold.	
Step 2	Pull the front of the shelf support away from the side wall.	
Step 3	Pull the rear end of the shelf support away from the side wall and remove it.	
Step 4	Install the shelf supports in the opposite sequence.	



12.3 How to use: Pyrolytic Cleaning

Clean the oven with Pyrolytic Cleaning.

 <p>WARNING! There is a risk of burns.</p>

 <p>CAUTION! If there are other appliances installed in the same cabinet, do not use them at the same time as this function. It can cause damage to the oven.</p>
--

Before the Pyrolytic Cleaning:		
Turn off the oven and wait until it is cold.	Remove all accessories.	Clean the oven floor and the inner door glass with warm water, a soft cloth and a mild detergent.

Pyrolytic Cleaning	
Step 1	Enter menu: Cleaning  .
Option	Duration
C1 - Light cleaning	1 h
C2 - Normal cleaning	1 h 30 min
C3 - Thorough cleaning	2 h 30 min
Step 2	OK - press to select the cleaning programme.
Step 3	OK - press to start the cleaning.
Step 4	After cleaning, turn the knob for the heating functions to the off position.
 During the cleaning the oven lamp is off.	
When the oven is at the set temperature, the door locks. Until the door unlocks the display shows:  .	

When the cleaning ends:		
Turn off the oven and wait until it is cold.	Clean the cavity with a soft cloth.	Remove the residue from the bottom of the cavity.

12.4 Cleaning Reminder

The oven reminds you when to clean it with pyrolytic cleaning.	
 flashes in the display for 5 sec after each cooking session.	To turn off the reminder enter the Menu and select Settings, Cleaning Reminder.

12.5 How to clean: Water tank





Step 1	Turn off the oven.
---------------	--------------------

CARE AND CLEANING

Step 2	Place a deep pan below the steam inlet.
Step 3	Pour water into the water drawer: 850 ml. Add citric acid: 5 teaspoons. Wait for 60 min.
Step 4	Turn on the oven and set the function: Humidity Low. Set the temperature to 230 °C. Turn off the oven after 25 min and wait until it is cold.
Step 5	Turn on the oven and set the function: Humidity Low. Set the temperature between 130 and 230 °C. Turn off the oven after 10 minutes and wait until it is cold.
 To prevent limestone residue empty the water tank after each steam cooking.	

When the cleaning ends:			
Turn off the oven.	Empty the water tank. Refer to Daily use, "Emptying the water tank" chapter.	Rinse the water tank and clean the remaining limestone residue with a soft cloth.	Clean the drain pipe with warm water and a mild detergent.

The table below shows water hardness range (dH) with the corresponding level of calcium deposit and the quality of water. When water hardness exceeds level 4, fill the water drawer with bottled water.

Water hardness		Test strip	Calcium deposit (mg/l)	Water classification	Clean the water tank every
Level	dH				
1	0 - 7		0 - 50	soft	75 cycles - 2.5 months
2	8 - 14		51 - 100	moderately hard	50 cycles - 2 months
3	15 - 21		101 - 150	hard	40 cycles - 1.5 months
4	22 - 28		over 151	very hard	30 cycles - 1 month

12.6 How to remove and install: Door

The oven door has three glass panels. You can remove the oven door and the internal glass panels to clean them. Read the whole "Removing and installing door" instruction before you remove the glass panels.

CARE AND CLEANING



CAUTION!

Do not use the oven without the glass panels.

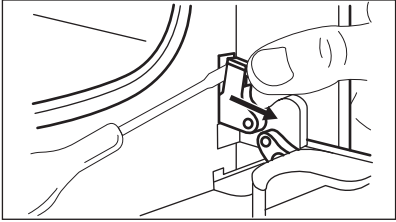
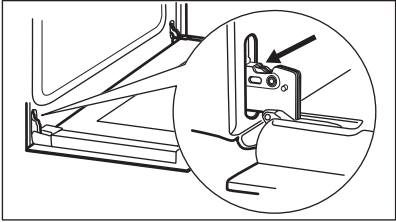
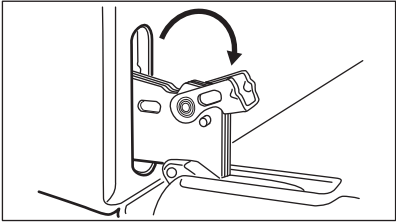
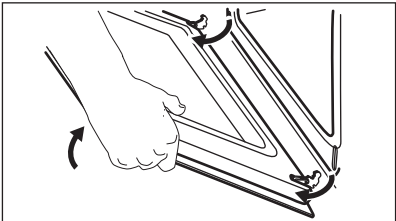
Step 1	Fully open the door and find the hinge to the right side of the door.	
Step 2	Use a screwdriver to lift and turn fully the right side hinge lever.	
Step 3	Find the hinge to the left side of the door.	
Step 4	Lift and turn the lever fully on the left hinge.	
Step 5	Close the oven door halfway to the first opening position. Then lift and pull forward and remove the door from its seat.	
Step 6	Put the door on a soft cloth on a stable surface.	
Step 7	Hold the door trim (B) on the top edge of the door at the two sides and push inwards to release the clip seal.	
Step 8	Pull the door trim to the front to remove it.	

CARE AND CLEANING

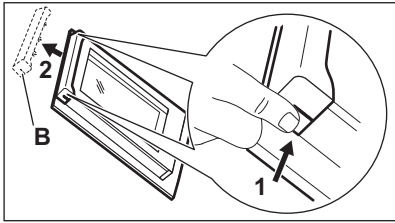
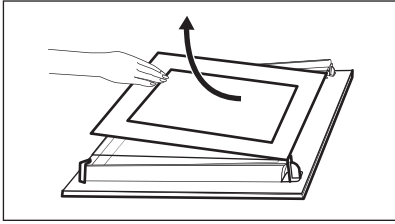
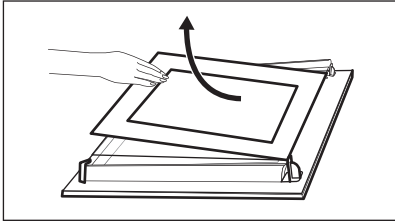
Step 9	Hold the door glass panels by their top edge and carefully pull them out one by one. Start from the top panel. Make sure the glass slides out of the supports completely.	
Step 10	Clean the glass panels with water and soap. Dry the glass panels carefully. Do not clean the glass panels in the dishwasher.	
Step 11	After cleaning, install the glass panels and the oven door.	

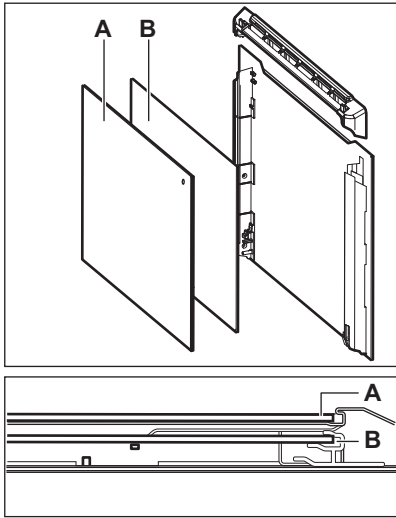
<p>Make sure that you put the glass panels (A and B) back in the correct sequence. Check for the symbol / printing on the side of the glass panel, each of the glass panels looks different to make the disassembly and assembly easier.</p> <p>When installed correctly the door trim clicks. Make sure that you install the middle panel of glass in the seats correctly.</p>	
---	--

12.7 How to replace: Lamp

	<p>WARNING! Risk of electric shock. The lamp can be hot.</p>
--	---

Always hold the halogen lamp with a cloth to prevent grease residue from burning on the lamp.

Before you replace the lamp:

Step 1	Step 2	Step 3
Turn off the oven. Wait until the oven is cold.	Disconnect the oven from the mains.	Put a cloth on the bottom of the cavity.

Back lamp

Step 1	Turn the glass cover to remove it.
Step 2	Clean the glass cover.
Step 3	Replace the lamp with a suitable 300 °C heat-resistant lamp.
Step 4	Install the glass cover.

13. TROUBLESHOOTING



WARNING!

Refer to Safety chapters.

13.1 What to do if...

In any cases not included in this table please contact with an Authorised Service Centre.

The oven does not turn on or does not heat up

Problem	Check if...
You cannot activate or operate the oven.	The oven is correctly connected to an electrical supply.
The oven does not heat up.	The automatic switch-off is deactivated.
The oven does not heat up.	The oven door is closed.
The oven does not heat up.	The fuse is not blown.
The oven does not heat up.	The Child Lock is off.



Components

Problem	Check if...

TROUBLESHOOTING

Components	
The lamp is turned off.	Moist Fan Baking - is turned on.
The lamp does not work.	The lamp is burnt out.
The Food sensor does not operate.	The plug of the Food sensor is fully inserted into the socket.

Error codes	
The display shows...	Check if...
Err C2	You removed the Food sensor plug from the socket.
Err C3	The oven door is closed or the door lock is not broken.
Err F102	The oven door is closed.
Err F102	The door lock is not broken.
00:00	There was a power cut. Set the time of day.
If the display shows an error code that is not in this table turn the house fuse off and on to restart the oven. If the error code recurs contact an Authorised Service Centre.	

Cleaning	
Problem	Check if...
There is water in the oven cavity.	There is not too much water in the water tank.
 - indicator is off.	There is enough water in the water tank. If water starts to leak in the oven, and the indicator is still off contact an Authorised Service Centre.
 - indicator is on.	There is enough water in the tank. If the tank is full and the indicator is still on contact an Authorised Service Centre.
The steam cooking does not work.	There is no lime residue in the steam inlet opening.

Cleaning	
The steam cooking does not work.	There is water in the water tank.
It takes more than three minutes to empty the water tank or the water leaks from the steam inlet opening.	There is no lime residue in the steam inlet opening. Clean the water tank.

13.2 Service data

If you cannot find a solution to the problem yourself, contact your dealer or an Authorised Service Centre.

The necessary data for the service centre is on the rating plate. The rating plate is on the front frame of the oven cavity. Do not remove the rating plate from the oven cavity.

We recommend that you write the data here:	
Model (MOD.)
Product number (PNC)
Serial number (S.N.)

14. ENERGY EFFICIENCY

14.1 Product Information and Product Information Sheet*

Supplier's name	AEG
Model identification	BSB578270M 949494787 BSE578270M 949494772 BSS57807BM 949494790 BSS578270M 949494786
Energy Efficiency Index	81.2
Energy efficiency class	A+
Energy consumption with a standard load, conventional mode	0.93 kWh/cycle
Energy consumption with a standard load, fan-forced mode	0.69 kWh/cycle

ENERGY EFFICIENCY

Number of cavities	1	
Heat source	Electricity	
Volume	72 l	
Type of oven	Built-In Oven	
Mass	BSB578270M	33.7 kg
	BSE578270M	32.9 kg
	BSS57807BM	34.8 kg
	BSS578270M	33.8 kg

* For European Union according to EU Regulations 65/2014 and 66/2014.
 For Republic of Belarus according to STB 2478-2017, Appendix G; STB 2477-2017, Annexes A and B.
 For Ukraine according to 568/32020.

Energy efficiency class is not applicable for Russia.

EN 60350-1 - Household electric cooking appliances - Part 1: Ranges, ovens, steam ovens and grills - Methods for measuring performance.

14.2 Energy saving



The oven has features which help you save energy during everyday cooking.

Make sure that the oven door is closed when the oven operates. Do not open the oven door too often during cooking. Keep the door gasket clean and make sure it is well fixed in its position.

Use metal cookware to improve energy saving.

When possible, do not preheat the oven before cooking.

Keep breaks between baking as short as possible when you prepare a few dishes at one time.

Cooking with fan

When possible, use the cooking functions with fan to save energy.

Residual heat

The fan and lamp continue to operate. When you turn off the oven, the display shows the residual heat. You can use that heat to keep the food warm.

When the cooking duration is longer than 30 min, reduce the oven temperature to minimum 3 - 10 min before the end of cooking. The residual heat inside the oven will continue to cook.

Use the residual heat to warm up other dishes.

Keep food warm

Choose the lowest possible temperature setting to use residual heat and keep a meal warm.

The residual heat indicator or temperature appears on the display.

Cooking with the lamp off

Turn off the lamp during cooking. Turn it on only when you need it.



Moist Fan Baking



Function designed to save energy during cooking.







When you use this function the lamp automatically turns off after 30 sec. You may turn on the lamp again but this action will reduce the expected energy savings.

15. MENU STRUCTURE

15.1 Menu

	 - select to enter the Menu.
---	---

Menu structure		
Assisted Cooking 	Cleaning 	Settings 



Step 1	Step 2	Step 3	Step 4	Step 5
 	 OK	 O1 - O15	 OK	
Select the Menu, Settings.	Confirm setting.	Select the setting.	Confirm setting.	Adjust the value and press OK.

Settings					
O1	Time of day	Change	O2	Display brightness	1 - 5
O3	Key tones	1 - Beep 2 - Click 3 - Sound off	O4	Buzzer volume	1 - 4
O5	Food Sensor Action	1 - Alarm and stop 2 - Alarm	O6	Uptimer	On / Off
O7	Light	On / Off	O8	Fast Heat Up	On / Off
O9	Cleaning Reminder	On / Off	O10	Wi-Fi	On / Off

MENU STRUCTURE

Settings					
O11	Auto remote operation	On / Off	O12	Forget network	Yes / No
O13	Demo mode	Activation code: 2468	O14	Software version	Check
O15	Reset all settings	Yes / No			

16. ENVIRONMENTAL CONCERNS

Recycle materials with the symbol . Put the packaging in relevant containers to recycle it. Help protect the environment and human health by recycling waste of electrical and electronic appliances. Do not dispose of appliances marked with the symbol  with the household waste. Return the product to your local recycling facility or contact your municipal office.

POUR DES RÉSULTATS PARFAITS

Merci d'avoir choisi ce produit AEG. Nous l'avons conçu pour qu'il vous offre des performances irréprochables pendant de nombreuses années, en intégrant des technologies innovantes vous simplifiant la vie – fonctions que vous ne trouverez peut-être pas sur des appareils ordinaires. Veuillez prendre quelques instants pour lire cette notice afin d'utiliser au mieux votre appareil. Consultez notre site pour :



Obtenir des conseils d'utilisation, des brochures, un dépanneur, des informations sur le service et les réparations :

www.aeg.com/support



Enregistrer votre produit pour un meilleur service :

www.registeraeg.com



Acheter des accessoires, consommables et pièces de rechange d'origine pour votre appareil :

www.aeg.com/shop



Pour plus de recettes, conseils, informations de dépannage, téléchargez l'application **My AEG Kitchen**.



SERVICE ET ASSISTANCE À LA CLIENTÈLE

N'utilisez que des pièces de rechange d'origine.

Avant de contacter notre centre de service agréé, assurez-vous de disposer des informations suivantes : Modèle, PNC, numéro de série.

Ces informations figurent sur la plaque signalétique.

 Avertissement/Consignes de sécurité

 Informations générales et conseils

 Informations environnementales

Sous réserve de modifications.

TABLE DES MATIÈRES

1. INFORMATION SUR LA SÉCURITÉ.....93	2.7 Éclairage intérieur..... 99
1.1 Sécurité des enfants et des personnes vulnérables.....93	2.8 Service..... 99
1.2 Sécurité générale..... 94	2.9 Mise au rebut..... 100
2. CONSIGNES DE SÉCURITÉ.....95	3. INSTALLATION..... 100
2.1 Installation.....95	3.1 Encastrement.....100
2.2 Branchement électrique.....96	3.2 Fixation du four au meuble..... 101
2.3 Utilisation..... 97	4. DESCRIPTION DE L'APPAREIL..... 102
2.4 Entretien et Nettoyage..... 98	4.1 Vue d'ensemble..... 102
2.5 Nettoyage par pyrolyse.....98	4.2 Accessoires..... 102
2.6 Cuisson à la vapeur.....99	

TABLE DES MATIÈRES

5. COMMENT ALLUMER ET ÉTEINDRE LE FOUR.....	103	10.3 Ventilateur de refroidissement...	120
5.1 Manettes rétractables.....	103	11. CONSEILS.....	120
5.2 Bandeau de commande.....	103	11.1 Circulation d'air humide.....	120
6. AVANT LA PREMIÈRE UTILISATION....	104	11.2 Circulation d'air humide - accessoires recommandés.....	122
6.1 Nettoyage initial.....	104	11.3 Tableaux de cuisson pour les instituts de tests.....	123
6.2 Préchauffage initial.....	104	12. ENTRETIEN ET NETTOYAGE.....	125
6.3 Connexion Wi-Fi 	105	12.1 Remarques concernant l'entretien.....	125
6.4 Licences du logiciel.....	106	12.2 Comment enlever : Supports de grille	126
7. UTILISATION QUOTIDIENNE.....	106	12.3 Comment utiliser : Nettoyage par pyrolyse.....	126
7.1 Comment régler : Modes de cuisson.....	106	12.4 Nettoyage conseillé.....	127
7.2 Modes de cuisson.....	107	12.5 Comment nettoyer : Réservoir d'eau.....	127
7.3 Remarques sur : Circulation d'air humide.....	108	12.6 Comment démonter et installer : Porte.....	129
7.4 Réservoir d'eau.....	108	12.7 Comment remplacer : Éclairage	130
7.5 Comment régler : Cuisson assistée.....	109	13. DÉPANNAGE.....	131
7.6 Cuisson assistée avec des recettes.....	110	13.1 Que faire si.....	131
8. FONCTIONS DE L'HORLOGE.....	115	13.2 Données de maintenance.....	133
8.1 Fonctions de l'horloge.....	115	14. RENDEMENT ÉNERGÉTIQUE.....	133
8.2 Comment régler : Fonctions de l'horloge.....	115	14.1 Informations produit et Fiche d'informations produit*.....	133
9. CONSEILS D'UTILISATION : ACCESSOIRES.....	117	14.2 Économie d'énergie.....	134
9.1 Insertion des accessoires.....	117	15. STRUCTURE DES MENUS.....	135
9.2 Sonde de cuisson.....	118	15.1 Menu	135
10. FONCTIONS SUPPLÉMENTAIRES.....	120	16. EN MATIÈRE DE PROTECTION DE L'ENVIRONNEMENT.....	136
10.1 Touches Verrouil.....	120		
10.2 Arrêt automatique.....	120		



1. ⚠ INFORMATION SUR LA SÉCURITÉ

Avant d'installer et d'utiliser cet appareil, lisez soigneusement les instructions fournies. Le fabricant ne pourra être tenu pour responsable des blessures et dégâts résultant d'une mauvaise installation ou utilisation. Conservez toujours les instructions dans un lieu sûr et accessible pour vous y référer ultérieurement.

1.1 Sécurité des enfants et des personnes vulnérables

- Cet appareil peut être utilisé par des enfants âgés d'au moins 8 ans et par des personnes ayant des capacités physiques, sensorielles ou mentales réduites ou dénuées d'expérience ou de connaissance, s'ils sont correctement surveillés ou si des instructions relatives à l'utilisation de l'appareil en toute sécurité leur ont été données et s'ils comprennent les risques encourus. Les enfants de moins de 8 ans et les personnes ayant un handicap très important et complexe doivent être tenus à l'écart de l'appareil, à moins d'être surveillés en permanence.

- Veillez à ce que les enfants ne jouent pas avec l'appareil et les appareils mobiles avec My AEG Kitchen.
- Ne laissez pas les emballages à la portée des enfants et jetez-les convenablement.
- **AVERTISSEMENT** : tenez les enfants et les animaux éloignés de l'appareil lorsqu'il est en cours de fonctionnement ou lorsqu'il refroidit. Les parties accessibles deviennent chaudes en cours d'utilisation.
- Si l'appareil est équipé d'un dispositif de sécurité enfants, nous vous recommandons de l'activer.
- Le nettoyage et l'entretien par l'utilisateur ne doivent pas être effectués par des enfants sans surveillance.

1.2 Sécurité générale

- Cet appareil doit être installé et le câble remplacé uniquement par un professionnel qualifié.
- N'utilisez pas l'appareil avant de l'avoir installé dans la structure encastrée.
- Débranchez l'appareil de l'alimentation électrique avant toute opération d'entretien.
- Si le câble d'alimentation secteur est endommagé, son remplacement doit être confié exclusivement au fabricant, à son service après-vente ou à toute autre personne qualifiée afin d'éviter tout danger électrique.
- **AVERTISSEMENT** : Assurez-vous que l'appareil est éteint avant de remplacer l'ampoule pour éviter tout risque d'électrocution.
- **AVERTISSEMENT** : L'appareil et ses parties accessibles deviennent chauds pendant l'utilisation. Veillez à ne pas toucher les éléments chauffants.
- Utilisez toujours des gants de cuisine pour retirer ou mettre des accessoires ou des plats allant au four.
- Utilisez uniquement la sonde de cuisson recommandée pour cet appareil.

- Pour retirer les supports de grille, tirez d'abord l'avant du support de grille, puis l'arrière à distance des parois latérales. Installez les supports de grille dans l'ordre inverse.
- N'utilisez pas de nettoyeur à vapeur pour nettoyer l'appareil.
- N'utilisez pas de produits abrasifs ni de racloirs pointus en métal pour nettoyer la porte en verre car ils peuvent rayer la surface, ce qui peut briser le verre.
- Retirez le plus gros des salissures avant le nettoyage par pyrolyse. Retirez toutes les pièces du four.

2. CONSIGNES DE SÉCURITÉ

2.1 Installation



AVERTISSEMENT!

L'appareil doit être installé uniquement par un professionnel qualifié.

- Retirez l'intégralité de l'emballage.
- N'installez pas et ne branchez pas un appareil endommagé.
- Suivez scrupuleusement les instructions d'installation fournies avec l'appareil.
- Soyez toujours vigilants lorsque vous déplacez l'appareil car il est lourd. Utilisez toujours des gants de sécurité et des chaussures fermées.
- Ne tirez jamais l'appareil par la poignée.
- Installez l'appareil dans un lieu sûr et adapté répondant aux exigences d'installation.
- Respectez l'espacement minimal requis par rapport aux autres appareils et éléments.
- Avant de monter l'appareil, vérifiez si la porte du four s'ouvre sans retenue.
- L'appareil est équipé d'un système de refroidissement électrique. Il doit être utilisé avec l'alimentation électrique.

Hauteur minimale du meuble (Hauteur minimale du meuble sous le plan de travail)	590 (600) (mm)
Largeur du meuble	560 (mm)
Profondeur du meuble	550 (550) (mm)
Hauteur de l'avant de l'appareil	594 (mm)
Hauteur de l'arrière de l'appareil	576 (mm)
Largeur de l'avant de l'appareil	595 (mm)
Largeur de l'arrière de l'appareil	559 (mm)

CONSIGNES DE SÉCURITÉ

Profondeur de l'appareil	569 (mm)
Profondeur d'encastrement de l'appareil	548 (mm)
Profondeur avec porte ouverte	1022 (mm)
Dimensions minimales de l'ouverture de ventilation. Ouverture placée sur la partie inférieure de la face arrière	560x20 (mm)
Longueur du câble d'alimentation secteur. Le câble est placé dans le coin droit de la face arrière	1500 (mm)
Vis de montage	4x25 (mm)

2.2 Branchement électrique



AVERTISSEMENT!

Risque d'incendie ou d'électrocution.

- Tous les raccordements électriques doivent être effectués par un électricien qualifié.
- L'appareil doit être relié à la terre.
- Assurez-vous que les paramètres figurant sur la plaque signalétique correspondent aux données électriques nominale de l'alimentation secteur.
- Utilisez toujours une prise de courant de sécurité correctement installée.
- N'utilisez pas d'adaptateurs multiprise et de rallonges.
- Veillez à ne pas endommager la fiche secteur ni le câble d'alimentation. Le remplacement du câble d'alimentation de l'appareil doit être effectué par notre service après-vente agréé.
- Ne laissez pas les câbles d'alimentation entrer en contact ou s'approcher de la porte de l'appareil ou de la niche d'encastrement sous l'appareil, particulièrement lorsqu'il est en marche ou que la porte est chaude.
- La protection contre les chocs des parties sous tension et isolées doit être fixée de telle manière qu'elle ne puisse pas être enlevée sans outils.
- Ne branchez la fiche secteur dans la prise secteur qu'à la fin de l'installation. Assurez-vous que la prise secteur est accessible après l'installation.
- Si la prise secteur est détachée, ne branchez pas la fiche secteur.
- Ne tirez pas sur le câble secteur pour débrancher l'appareil. Tirez toujours sur la fiche de la prise secteur.
- N'utilisez que des systèmes d'isolation appropriés : des coupe-circuits, des fusibles (les fusibles à visser doivent être retirés du support), un disjoncteur différentiel et des contacteurs.
- L'installation électrique doit comporter un dispositif d'isolation qui vous permet de déconnecter l'appareil du secteur à tous les pôles. Le dispositif d'isolement doit avoir une largeur d'ouverture de contact de 3 mm minimum.
- Fermez bien la porte de l'appareil avant de brancher la fiche à la prise secteur.
- Cet appareil est fourni avec une fiche électrique et un câble d'alimentation.

Types de câbles compatibles pour l'installation ou le remplacement pour l'Europe :

H07 RN-F, H05 RN-F, H05 RRF, H05 VV-F, H05 V2V2-F (T90), H05 BB-F

Pour la section du câble, consultez la puissance totale sur la plaque signalétique. Vous pouvez également consulter le tableau :

Puissance totale (W)	Section du câble (mm ²)
maximum 1 380	3 x 0.75
maximum 2 300	3 x 1
maximum 3 680	3 x 1.5

Le fil de terre (câble vert/jaune) doit être 2 cm plus long que les câbles de phase et neutre (câbles bleu et marron).

2.3 Utilisation



AVERTISSEMENT!

Risque de blessures, de brûlures, d'électrocution ou d'explosion.

- Cet appareil est exclusivement à usage domestique (en intérieur).
- Ne modifiez pas les spécifications de cet appareil.
- Assurez-vous que les orifices d'aération ne sont pas obstrués.
- Ne laissez pas l'appareil sans surveillance durant son fonctionnement.
- Éteignez l'appareil après chaque utilisation.
- Soyez prudent lors de l'ouverture de la porte de l'appareil lorsque celui-ci fonctionne. De l'air chaud peut se dégager.
- N'utilisez pas l'appareil avec des mains mouillées ou en contact avec de l'eau.
- N'exercez pas de pression sur la porte ouverte.
- N'utilisez pas l'appareil comme plan de travail ou comme espace de rangement.
- Ouvrez la porte de l'appareil avec précaution. L'utilisation d'ingrédients avec de l'alcool peut provoquer un mélange d'alcool et d'air.
- Ne laissez pas des étincelles ou des flammes nues entrer en contact avec l'appareil lorsque vous ouvrez la porte.
- Ne placez pas de produits inflammables ou d'éléments imbibés de produits inflammables à l'intérieur, à proximité ou au-dessus de l'appareil.
- Ne communiquez pas votre mot de passe wifi.



AVERTISSEMENT!

Risque d'endommagement de l'appareil.

- Pour éviter tout endommagement ou décoloration de l'émail :
 - ne posez pas de plats allant au four ou d'autres objets directement dans le fond de l'appareil.
 - ne placez jamais de feuilles d'aluminium directement sur le fond de la cavité de l'appareil.

CONSIGNES DE SÉCURITÉ

- ne versez pas d'eau directement dans l'appareil chaud.
- ne conservez pas de plats et de nourriture humides dans l'appareil après avoir terminé la cuisson.
- Installez ou retirez les accessoires avec précautions.
- La décoloration de l'émail ou de l'acier inoxydable est sans effet sur les performances de l'appareil.
- Utilisez un plat à rôtir pour des gâteaux moelleux. Les jus de fruits provoquent des taches qui peuvent être permanentes.
- Cet appareil est exclusivement destiné à un usage culinaire. Il ne doit pas être utilisé à d'autres fins, par exemple pour chauffer une pièce.
- Cuisinez toujours avec la porte du four fermée.
- Si l'appareil est installé derrière la paroi d'un meuble (par ex. une porte), veuillez à ce que la porte ne soit jamais fermée lorsque l'appareil fonctionne. La chaleur et l'humidité peuvent s'accumuler derrière la porte fermée du meuble et provoquer d'importants dégâts sur l'appareil, votre logement ou le sol. Ne fermez pas la paroi du meuble tant que l'appareil n'a pas refroidi complètement.

2.4 Entretien et Nettoyage



AVERTISSEMENT!

Risque de blessure, d'incendie ou de dommages matériels sur l'appareil.

- Avant toute opération d'entretien, éteignez l'appareil et débranchez la fiche de la prise secteur.
- Vérifiez que l'appareil est froid. Les panneaux de verre risquent de se briser.
- Remplacez immédiatement les vitres de la porte si elles sont endommagées. Contactez le service après-vente agréé.
- Soyez prudent lorsque vous retirez la porte de l'appareil. La porte est lourde !
- Nettoyez régulièrement l'appareil afin de maintenir le revêtement en bon état.
- Nettoyez l'appareil avec un chiffon doux humide. Utilisez uniquement des produits de lavage neutres. N'utilisez pas de produits abrasifs, de tampons à récurer, de solvants ni d'objets métalliques.
- Si vous utilisez un spray pour four, suivez les consignes de sécurité figurant sur son emballage.

2.5 Nettoyage par pyrolyse



AVERTISSEMENT!

Risque de blessures, d'incendie, d'émissions chimiques (fumées) en mode pyrolyse.

- Avant d'utiliser la fonction de nettoyage par pyrolyse ou la fonction Première utilisation, retirez de la cavité du four :
 - tout résidu excessif de nourriture, tout dépôt ou toute éclaboussure de graisse ou d'huile.
 - tout objet amovible (y compris les grilles, les rails, etc., fournis avec le produit), en particulier les récipients, plateaux, plaques, ustensiles, etc. anti-adhésifs.
- Lisez attentivement toutes les instructions relatives au nettoyage par pyrolyse.
- Tenez les jeunes éloignés de l'appareil lorsque le nettoyage par pyrolyse est en cours. L'appareil devient très chaud et de l'air chaud s'échappe des fentes d'aération avant.

- Le nettoyage par pyrolyse est un processus à haute température qui peut dégager de la fumée provenant des résidus alimentaires et des matériaux dont est fait le four. Par conséquent, nous recommandons à nos clients de suivre les conseils ci-dessous :
 - assurez-vous que la ventilation de l'appareil est adéquate pendant et après chaque phase de nettoyage par pyrolyse.
 - assurez-vous que la ventilation de l'appareil est adéquate pendant et après la première utilisation à température maximale.
- Contrairement aux humains, certains oiseaux et reptiles sont extrêmement sensibles aux fumées pouvant se dégager lors du processus de nettoyage des fours à pyrolyse.
 - Ne laissez aucun animal, en particulier aucun oiseau, à proximité de l'appareil pendant et après un nettoyage par pyrolyse ; la première fois, utilisez la température de fonctionnement maximale dans une pièce bien ventilée.
- Les animaux de petite taille peuvent également être très sensibles aux changements de température survenant à proximité d'un four à pyrolyse lorsque le processus de nettoyage est en cours.
- Les surfaces antiadhésives des ustensiles de cuisine (poêles, casseroles, plaques de cuisson, etc.) peuvent être endommagées par la très haute température nécessaire au nettoyage par pyrolyse et peuvent également dégager, dans une moindre mesure, des fumées nocives.
- Les fumées dégagées par les fours à pyrolyse / les résidus de cuisson sont décrites comme étant non nocives pour les êtres humains, y compris pour les enfants et les personnes à la santé fragile.

2.6 Cuisson à la vapeur



AVERTISSEMENT!

Risque de brûlures et de dommages matériels à l'appareil.

- La vapeur qui s'échappe peut provoquer des brûlures :
 - Au cours de la cuisson à la vapeur, n'ouvrez pas la porte de l'appareil.
 - Soyez prudent en ouvrant la porte de l'appareil après une cuisson à la vapeur.

2.7 Éclairage intérieur



AVERTISSEMENT!

Risque d'électrocution !

- Concernant la/les lampe(s) à l'intérieur de ce produit et les lampes de rechange vendues séparément : Ces lampes sont conçues pour résister à des conditions physiques extrêmes dans les appareils électroménagers, telles que la température, les vibrations, l'humidité, ou sont conçues pour signaler des informations sur le statut opérationnel de l'appareil. Elles ne sont pas destinées à être utilisées dans d'autres applications et ne conviennent pas à l'éclairage des pièces d'un logement.
- Utilisez uniquement des ampoules ayant les mêmes spécifications.

2.8 Service

- Pour réparer l'appareil, contactez le service après-vente agréé.
- Utilisez uniquement des pièces de rechange d'origine.

INSTALLATION

2.9 Mise au rebut



AVERTISSEMENT!

Risque de blessure ou d'asphyxie.

- Contactez votre service municipal pour obtenir des informations sur la marche à suivre pour mettre l'appareil au rebut.
- Débranchez l'appareil de l'alimentation électrique.
- Coupez le câble d'alimentation au ras de l'appareil et mettez-le au rebut.
- Retirez le dispositif de verrouillage du hublot pour empêcher les jeunes et les animaux de s'enfermer dans l'appareil.

3. INSTALLATION



AVERTISSEMENT!

Reportez-vous aux chapitres concernant la sécurité.

3.1 Encastrement



YouTube

www.youtube.com/electrolux
www.youtube.com/aeg

How to install your AEG/Electrolux
Oven - Column installation

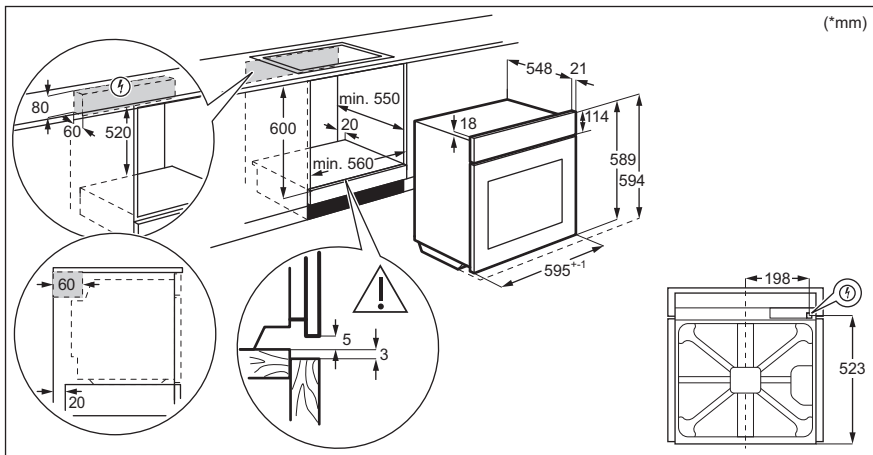

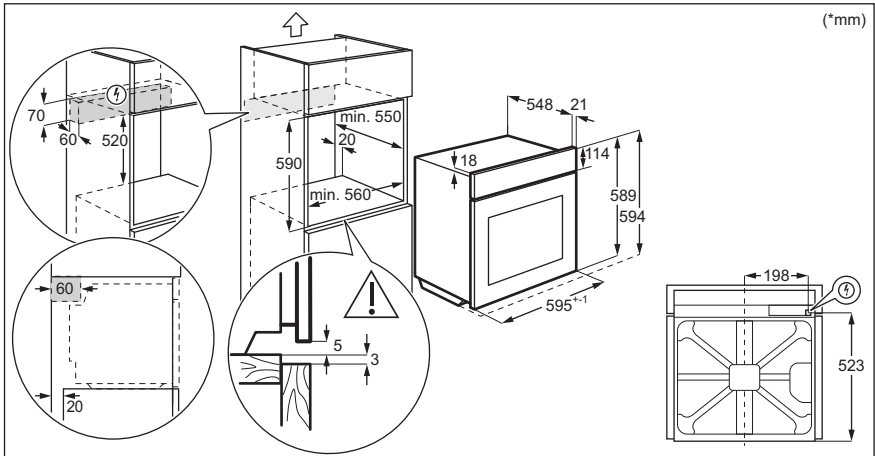

3.2 Fixation du four au meuble

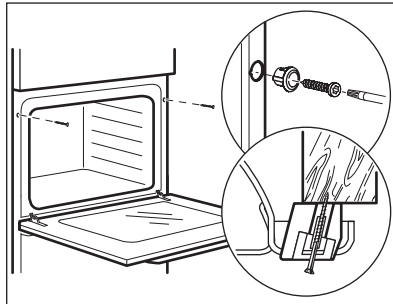

4. DESCRIPTION DE L'APPAREIL

4.1 Vue d'ensemble

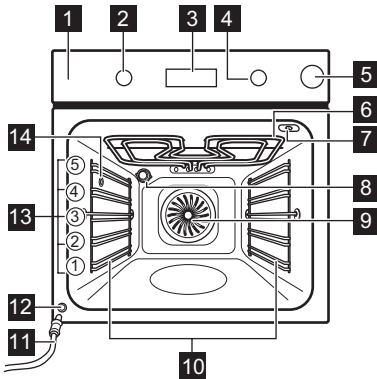

- 1** Bandeau de commande
- 2** Manette de sélection des modes de cuisson
- 3** Affichage
- 4** Manette de commande
- 5** Bac à eau
- 6** Résistance
- 7** Prise pour la sonde à viande
- 8** Éclairage
- 9** Chaleur tournante
- 10** Support de grille, amovible
- 11** Tuyau de vidange
- 12** Vanne de vidange de l'eau
- 13** Niveaux de la grille
- 14** Tuyau d'arrivée de la vapeur

4.2 Accessoires







- **Grille métallique**
Pour les plats de cuisson, les moules à gâteaux, les rôtis.
- **Plateau de cuisson**
Pour les gâteaux et biscuits.
- **Plat à rôtir**
Pour cuire et rôtir ou comme plat pour récupérer la graisse.
- **Sonde de cuisson**
Pour mesurer le degré de cuisson des aliments.

5. COMMENT ALLUMER ET ÉTEINDRE LE FOUR

5.1 Manettes rétractables



Pour utiliser l'appareil, appuyez sur la manette. La manette sort alors de son logement.



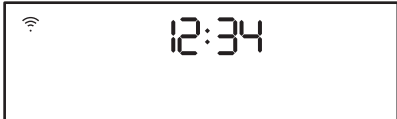

5.2 Bandeau de commande

Touches tactiles du bandeau de commande					Appuyez sur la touche	Tournez la manette
 Minuteur	 Préchauffage rapide	 Eclairage four	 Sonde de cuisson	OK		

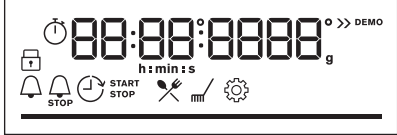









Sélectionnez un mode de cuisson pour allumer le four.

Tournez la manette des modes de cuisson sur la position Arrêt pour éteindre le four.

	Lorsque la manette des modes de cuisson est en position Arrêt, l'affichage se met en veille.
	Lorsque vous cuisinez, l'affichage indique la température réglée, l'heure et d'autres options disponibles.
	L'affichage avec le nombre maximal de fonctions réglées.

Voyants de l'affichage				
 Touches Verrouil.	 Cuisson assistée	 Nettoyage	 Configurations	 Préchauffage rapide

AVANT LA PREMIÈRE UTILISATION

Voyants du minuteur :				
Voyant Wi-Fi : - clignote lorsque le four peut être connecté au Wi-Fi.		Télécommande indicateur - le four peut être contrôlé à distance.		
 La connexion Wi-Fi : est activée.		 Télécommande est allumé.		
Barre de progression - de la température ou de l'heure.				
Voyants de la réserve d'eau				
				
Sonde de cuisson Voyant				

6. AVANT LA PREMIÈRE UTILISATION







AVERTISSEMENT!

Reportez-vous aux chapitres concernant la sécurité.

6.1 Nettoyage initial

Avant la première utilisation, nettoyez le four à vide et réglez la durée :

			 0:00. Réglez l'heure. Appuyez sur la touche OK.
---	---	---	--

6.2 Préchauffage initial

Préchauffez le four à vide avant de l'utiliser pour la première fois.

Étape 1	Retirez les supports de grille amovibles et tous les accessoires du four.
----------------	---

AVANT LA PREMIÈRE UTILISATION

Préchauffez le four à vide avant de l'utiliser pour la première fois.

Étape 2 Réglez la température maximale pour la fonction : .
Laissez le four fonctionner pendant 1 heure.

Étape 3 Réglez la température maximale pour la fonction : .
Laissez le four fonctionner pendant 15 minutes.

 Une odeur et de la fumée peuvent s'échapper du four durant le préchauffage. Assurez-vous que la pièce est ventilée.

6.3 Connexion Wi-Fi

Pour connecter le four, vous avez besoin :

- Un réseau sans fil avec connexion Internet.
- d'un appareil mobile connecté à votre réseau sans fil.

Étape 1 Téléchargez l'application mobile My AEG Kitchen et suivez les instructions pour les étapes suivantes.

Étape 2 Tournez la manette pour sélectionner : .

Fréquence	WLAN 2,4 Ghz	5 GHz WLAN
	2 400 - 2 483,5 Mhz	5150 - 5350 MHz 5470 - 5725 MHz
Protocoles	IEEE 802.11b DSSS, 802.11g/n OFDM	IEEE 802.11 a/n OFDM
Puissance max.	EIRP < 20 dBm (100 mW)	EIRP < 23 dBm (200 mW)
Module Wi-Fi	NIU5-50	

Fréquence Bluetooth	2 400 - 2 483,5 Mhz
Protocoles	LE : DSSS
Puissance max.	EIRP < 4 dBm (2.5 mW)

Pays couverts par la disposition de la Directive 2014/53/UE : Belgique, Bulgarie, République tchèque, Danemark, Allemagne, Estonie, Irlande, Grèce, Espagne, France, Croatie, Italie, Chypre, Lettonie, Lituanie, Luxembourg, Hongrie, Malte, Pays-Bas, Irlande du Nord, Autriche,

UTILISATION QUOTIDIENNE

Pologne, Portugal, Roumanie, Slovénie, Slovaquie, Finlande, Suède, Norvège, Islande, Liechtenstein, Suisse, Turquie.

6.4 Licences du logiciel

Le logiciel de ce produit contient des composants basés sur un logiciel libre et ouvert. AEG reconnaît pleinement les contributions du logiciel ouvert et des communautés robotiques au projet de développement.

Pour accéder au code source de ces composants logiciels libres et ouverts dont les conditions de licence doivent être publiées, et pour consulter leurs informations complètes sur le copyright et les conditions de licence applicables, rendez-vous sur : <http://aeg.opensoftwarerepository.com> (dossier NIU5).



7. UTILISATION QUOTIDIENNE







AVERTISSEMENT!

Reportez-vous aux chapitres concernant la sécurité.









7.1 Comment régler : Modes de cuisson



Pour lancer la cuisson	
Étape 1	Étape 2
	
Sélectionnez un mode de cuisson.	Réglez la température.

Cuisson à la vapeur				
Étape 1	Étape 2	Étape 3	Étape 4	Étape 5
				
Appuyez sur le couvercle du bac à eau pour l'ouvrir.	Remplissez le bac à eau avec 900 ml d'eau.	Remplacez le bac à eau dans sa position initiale.	Réglez le mode de cuisson vapeur.	Réglez la température.

7.2 Modes de cuisson

Modes de cuisson standard

Mode de cuisson	Application
 Chaleur tournante	Pour faire cuire sur 3 niveaux en même temps et pour sécher des aliments. Diminuez les températures de 20 à 40 °C par rapport à la Chauffage Haut/Bas.
 Chauffage Haut/Bas	Pour cuire et rôtir des aliments sur un seul niveau.
 Humidité Faible	Cette fonction convient pour la viande, la volaille, les plats au four et les ragoûts. Grâce à sa combinaison de vapeur et de chaleur, la viande conserve une texture tendre et juteuse, ainsi qu'une surface croustillante.
 Fonction Pizza	Pour cuire des pizzas. Pour faire dorer de façon intensive et obtenir un dessous croustillant.
 Cuisson de sole	Pour cuire des gâteaux à fond croustillant et pour stériliser des aliments.
 Plats Surgelés	Pour rendre croustillants vos plats préparés, tels que frites, pommes quartiers et nems.
 Circulation d'air humide	Cette fonction est conçue pour économiser de l'énergie en cours de cuisson. Lorsque vous utilisez cette fonction, la température à l'intérieur de la cavité peut différer de la température sélectionnée. La chaleur résiduelle est utilisée. La puissance peut être réduite. Pour plus d'informations, consultez la partie sur les remarques du chapitre « Utilisation quotidienne ». Circulation d'air humide.
 Gril	Pour faire griller des aliments peu épais et du pain.

Mode de cuisson	Application
 Turbo grill	Pour rôti de gros morceaux de viande ou de volaille avec os sur un seul niveau. Pour gratiner et faire dorer.
 Menu	Pour accéder au menu : Cuisson assistée, Nettoyage, Configurations.



7.3 Remarques sur : Circulation d'air humide

Cette fonction était utilisée pour se conformer à la classe d'efficacité énergétique et aux exigences Ecodesign selon les normes EU 65/2014 et UE 66/2014. Tests conformément à la norme EN 60350-1.

La porte du four doit être fermée pendant la cuisson pour que la fonction ne soit pas interrompue et que le four fonctionne avec la plus grande efficacité énergétique possible. Lorsque vous utilisez cette fonction, l'éclairage s'éteint automatiquement au bout de 30 secondes.

Pour consulter les instructions de cuisson, reportez-vous au chapitre « Conseils », Circulation d'air humide. Pour obtenir des recommandations générales sur l'économie d'énergie, reportez-vous au chapitre « Efficacité énergétique », « Économie d'énergie ».

7.4 Réservoir d'eau

Affichage de la réserve d'eau	
	Le réservoir est plein.
	Le réservoir est à moitié plein.
	Le réservoir est vide. Remplissez le réservoir.
Si vous versez trop d'eau dans le réservoir, le dispositif de sécurité déversera l'excédent d'eau dans le fond de la cavité. Épongez l'excédent d'eau.	



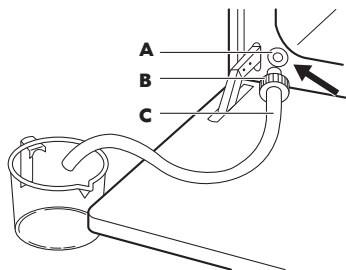

Vidange du réservoir d'eau	
Étape 1	Éteignez le four, laissez la porte ouverte et attendez que le four soit froid.
Étape 2	Raccordez le tuyau de vidange (C) à la vanne de vidange (A) via le connecteur (B).
Étape 3	Maintenez l'extrémité du tuyau au-dessous du niveau A et appuyez à plusieurs reprises sur la touche B pour récupérer l'eau résiduelle.
Étape 4	Détachez C et B et séchez le four avec une éponge douce.







7.5 Comment régler : Cuisson assistée

Chaque plat apparaissant dans ce sous-menu a une fonction et une température recommandées. Vous pouvez régler la durée et la température pendant la cuisson.









Pour certains plats, vous pouvez également réaliser la cuisson avec :	Le niveau de cuisson du plat :
<ul style="list-style-type: none"> • Sonde de cuisson 	<ul style="list-style-type: none"> • Saignant • À point • Bien cuit







Cuisson assistée - vous pouvez l'utiliser pour préparer un plat rapidement avec les réglages par défaut :			
Étape 1	Étape 2	Étape 3	Étape 4
			
Accédez au menu.	Sélectionner Cuisson assistée. Appuyez sur OK.	Sélectionnez le plat. Appuyez sur la touche OK.	Placez le plat dans le four. Confirmez la configuration.

7.6 Cuisson assistée avec des recettes

















Légende	
	Sonde de cuisson disponible. Placez la Sonde de cuisson dans la partie la plus épaisse du plat. Le four s'éteint lorsque la température définie de la Sonde de cuisson est atteinte.
	Ajoutez de l'eau dans le réservoir.
	Préchauffez le four avant de commencer la cuisson.
	Niveau de grille.





















Lorsque la fonction se termine, vérifiez si les aliments sont prêts.

	Plat	Poids	Niveau/Accessoire	Durée
Bœuf 				
P1	Rôti de bœuf, saignant	1 - 1,5 kg ; 4 - 5 cm d'épaisseur	  2 ; plateau de cuisson Faire frir la viande pendant quelques minutes sur une poêle chaude. Insérez au four.	~ 40 min
P2	Rôti de bœuf, à point			~ 50 min
P3	Rôti de bœuf, bien cuit			~ 60 min
P4	Steak de bœuf, à point	180 - 220 g par pièce ; 3 cm d'épaisseur	   3 ; plat à rôtir sur grille métallique Faire frir la viande pendant quelques minutes sur une poêle chaude. Insérez au four.	~ 15 min
P5	Bœuf rôti/braisé (côte de bœuf, intérieur de ronde, flanchet)	1,5 - 2 kg	  2 ; plat à rôtir sur grille métallique Faire frir la viande pendant quelques minutes sur une poêle chaude. Ajoutez du liquide. Insérez au four.	~ 120 min

















	Plat	Poids	Niveau/Accessoire	Durée
P6	Rôti de bœuf, saignant (cuisson basse température)	1 - 1,5 kg ; 4 - 5 cm d'épaisseur	 2 ; plateau de cuisson Servez-vous de vos épices préférées ou simplement du sel et du poivre fraîchement moulu. Faire frire la viande pendant quelques minutes sur une poêle chaude. Insérez au four.	~ 75 min
P7	Rôti de bœuf, à point (cuisson basse température)			~ 85 min
P8	Rôti de bœuf, bien cuit (cuisson basse température)			~ 130 min
P9	Filet, saignant (cuisson basse température)	0,5 - 1,5 kg ; 5 - 6 cm d'épaisseur	 2 ; plateau de cuisson Servez-vous de vos épices préférées ou simplement du sel et du poivre fraîchement moulu. Faire frire la viande pendant quelques minutes sur une poêle chaude. Insérez au four.	~ 75 min
P10	Filet, à point (cuisson basse température)			~ 90 min
P11	Filet, bien cuit (cuisson basse température)			~ 120 min
Veau 				
P12	Rôti de veau (par ex. épaule)	0,8 - 1,5 kg ; 4 cm d'épaisseur	 2 ; plat à rôtir sur grille métallique Utilisez vos épices préférées. Ajoutez du liquide. Rôti couvert.	~ 80 min
Porc 				
P13	Rôti de porc - collet ou épaule	1,5 - 2 kg	  1 ; plat à rôtir sur grille métallique Retournez la viande à la moitié du temps de cuisson.	~ 165 min









UTILISATION QUOTIDIENNE

	Plat	Poids	Niveau/Accessoire	Durée
P14	Émincé de porc CBT	1,5 - 2 kg	  2 ; plateau de cuisson Utilisez vos épices préférées. Retournez la viande à la moitié du temps de cuisson pour faire dorer de manière homogène.	~ 215 min
P15	Longe, fraîche	1 - 1,5 kg ; 5 - 6 cm d'épaisseur	  2 ; plat à rôtir sur grille métallique Utilisez vos épices préférées.	~ 55 min
P16	Travers	2 - 3 kg ; crus, 2 - 3 cm d'épaisseur	 3 plat profond Ajoutez du liquide pour recouvrir le fond d'un plat. Retournez la viande à la moitié du temps de cuisson.	90 min
Agneau 				
P17	Gigot d'agneau avec os	1,5 - 2 kg ; 7 - 9 cm d'épaisseur	  2 ; plat à rôtir sur plateau de cuisson Ajoutez du liquide. Retournez la viande à la moitié du temps de cuisson.	~ 130 min
Volaille 				
P18	Poulet entier	1 - 1,5 kg ; frais	  2 ; cocotte sur plateau de cuisson Utilisez vos épices préférées. Retournez le poulet à la moitié du temps de cuisson pour faire dorer de manière homogène.	~ 60 min
P19	Demi poulet	0,5 - 0,8 kg	  3 ; plateau de cuisson Utilisez vos épices préférées.	~ 40 min
P20	Escalope de poulet	180 - 200 g par pièce	  2 ; cocotte sur grille métallique Utilisez vos épices préférées. Faire frire la viande pendant quelques minutes sur une poêle chaude.	~ 25 min
P21	Cuisses de poulet, fraîches	-	  3 ; plateau de cuisson Si vous avez mariné les cuisses de poulet, réglez une température inférieure et faites-les cuire plus longtemps.	~ 30 min

	Plat	Poids	Niveau/Accessoire	Durée
P22	Canard entier	2 - 3 kg	  2 ; plat à rôtir sur grille métallique Utilisez vos épices préférées. Placez la viande sur un plat à rôtir. Retournez le canard à la moitié du temps de cuisson.	~ 100 min
P23	Oie entière	4 - 5 kg	  2 ; plat profond Utilisez vos épices préférées. Placez la viande sur un plateau de cuisson profond. Retournez l'oie à la moitié du temps de cuisson.	~ 110 min
Autres 				
P24	Rôti haché	1 kg	  2 ; grille métallique Utilisez vos épices préférées.	~ 60 min
 Poisson				
P25	Poisson entier, grillé	0,5 - 1 kg par poisson	  2 ; plateau de cuisson Remplissez le poisson avec du beurre et utilisez vos épices et herbes préférées.	~ 30 min
P26	Filet de poisson	-	  3 ; cocotte sur grille métallique Utilisez vos épices préférées.	35 min
Gâteaux/desserts   				
P27	Cheesecake	-	 2 ;  moule à charnière de 28 cm sur grille métallique	90 min
P28	Gâteau aux pommes	-	 3 ; plateau de cuisson	45 min
P29	Tarte aux pommes	-	 2 ; moule à tarte sur grille métallique	40 min
P30	Tarte aux pommes	-	 1 ;  moule à tarte de 22 cm sur grille métallique	60 min





UTILISATION QUOTIDIENNE

	Plat	Poids	Niveau/Accessoire	Durée
P31	Brownies	2 kg	 3 ; plat profond	30 min
P32	Muffins au chocolat	-	 3 ; bac à muffins sur grille métallique	25 min
P33	Quatre-quarts	-	 2 ; moule quatre-quarts sur grille métallique	50 min
Légumes/Garnitures 				
P34	Pommes de terre au four	1 kg	 2 ; plateau de cuisson Placez les pommes de terre entières avec la peau sur un plateau de cuisson.	50 min
P35	Quartiers	1 kg	 3 ; plateau de cuisson recouvert de papier sulfurisé Utilisez vos épices préférées. Coupez les pommes de terre en morceaux.	35 min
P36	Mélange de légumes grillés	1 - 1,5 kg	 3 ; plateau de cuisson recouvert de papier sulfurisé Utilisez vos épices préférées. Coupez les légumes en morceaux.	30 min
P37	Croquettes surgelées	0,5 kg	 3 ; plateau de cuisson	25 min
P38	Pommes, surgelées	0,75 kg	 3 ; plateau de cuisson	25 min
Gratins, pain et pizza 				
P39	Lasagnes/Cocotte de nouilles	1 - 1,5 kg	  2 ; cocotte sur grille métallique	55 min
P40	Gratin de pommes de terre	1 - 1,5 kg	  1 ; cocotte sur grille métallique	60 min
P41	Pizza fraîche, fine	-	   2 ; plateau de cuisson recouvert de papier sulfurisé	35 min

	Plat	Poids	Niveau/Accessoire	Durée
P42	Pizza fraîche, épaisse	-	  2 ; plateau de cuisson recouvert de papier sulfurisé	25 min
P43	Quiche	-	 2 ; plat de cuisson sur grille métallique	45 min
P44	Baguette/ Ciabatta/Pain blanc	0,8 kg	   2 ; plateau de cuisson recouvert de papier sulfurisé Prolonger le temps pour le pain blanc.	50 min
P45	Tous grains/ seigle/pain complet grains entiers dans un moule à pain	1 kg	  2 ; plateau de cuisson recouvert de papier sulfurisé/grille métallique	60 min

8. FONCTIONS DE L'HORLOGE

8.1 Fonctions de l'horloge



Fonctions de l'horloge	Application
	Minuteur. Lorsque le minuteur termine le décompte, le signal sonore retentit.
	Heure de cuisson. Lorsque le minuteur termine le décompte, le signal sonore retentit et le mode de cuisson s'arrête.
	Départ différé. Pour reporter le début et/ou la fin de la cuisson.
	Compteur. Le maximum est de 23 h 59 min. Cette fonction n'a aucun effet sur le fonctionnement du four. Pour activer et désactiver le Compteur, sélectionnez : Menu , Configurations.

8.2 Comment régler : Fonctions de l'horloge





Comment régler Heure actuelle		
Étape 1	Étape 2	Étape 3

FONCTIONS DE L'HORLOGE

Comment régler Heure actuelle







		
Pour modifier l'heure actuelle, accédez au menu et sélectionnez Configurations, Heure actuelle.	Réglez l'horloge.	Appuyez sur OK.

Comment régler Minuteur

Étape 1	L'affichage indique : 0:00 	Étape 2	Étape 3
			
Appuyez sur : 		Réglez la Minuteur	Appuyez sur OK.











i Le minuteur commence son décompte immédiatement.

Comment régler Heure de cuisson

Étape 1	Étape 2	L'affichage indique : 0:00  STOP	Étape 3	Étape 4
				
Choisissez le mode de cuisson et réglez la température.	Appuyez à plusieurs reprises : 		Réglez le temps de cuisson.	Appuyez sur OK.

i Le minuteur commence son décompte immédiatement.

CONSEILS D'UTILISATION : ACCESSOIRES

Comment régler Départ différé							
Étape 1	Étape 2		Étape 3	Étape 4		Étape 5	Étape 6
		L'affichage indique : l'heure actuelle			L'affichage indique : --:--		
Sélectionnez le mode de cuisson.	Appuyez à plusieurs reprises : 	 DÉ-MAR-RER	Réglez l'heure de départ.	Appuyez sur OK.	 AR-RÊTER	Réglez l'heure de fin.	Appuyez sur OK.
 Le minuteur commence à compter à l'heure réglée.							

9. CONSEILS D'UTILISATION : ACCESSOIRES

9.1 Insertion des accessoires

Une petite indentation sur le dessus apporte plus de sécurité. Les indentations sont également des dispositifs anti-bascule. Le rebord élevé de la grille empêche les ustensiles de cuisine de glisser sur la grille.

Grille métallique:

Poussez la grille entre les barres de guidage des supports de grille et assurez-vous que les pieds sont orientés vers le bas.

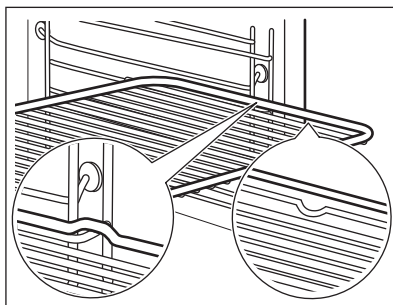

CONSEILS D'UTILISATION : ACCESSOIRES

Plateau de cuisson / Plat à rôtir:

Poussez la plaque entre les rails du support de grille.

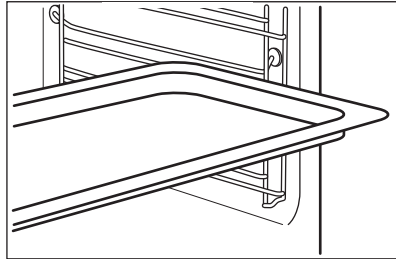

Grille métallique, Plateau de cuisson / Plat à rôtir:

Poussez la plaque entre les rails du support de grille et glissez la grille métallique entre les rails se trouvant juste au-dessus.

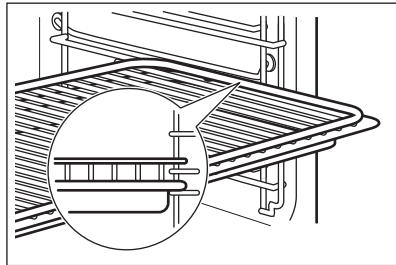

9.2 Sonde de cuisson

Sonde de cuisson - mesure la température à l'intérieur des aliments.

Il y a deux températures à régler :



La température du four.



La température au cœur.

Pour obtenir les meilleurs résultats de cuisson :

Les ingrédients doivent être à température ambiante.



Ne l'utilisez pas pour des plats liquides.

Pendant la cuisson, l'aliment doit rester dans le plat.

Comment utiliser : Sonde de cuisson



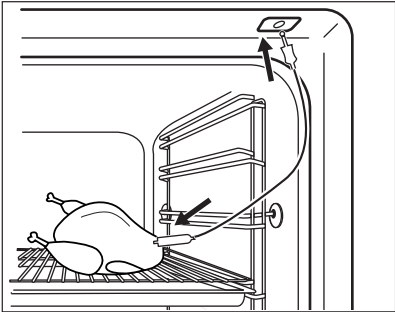
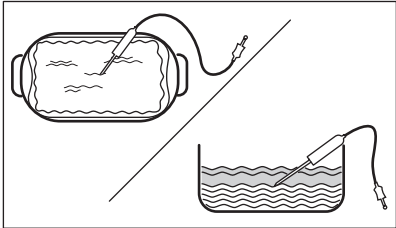

Étape 1	Allumez le four.
Étape 2	Réglez le mode de cuisson et, si nécessaire, la température du four.
Étape 3	Insérez : Sonde de cuisson.

CONSEILS D'UTILISATION : ACCESSOIRES

Viande, volaille et poisson	Ragoût
<p>Insérez la pointe de la Sonde de cuisson au centre de la viande ou du poisson, dans la partie la plus épaisse si possible. Assurez-vous qu'au moins les 3/4 de la Sonde de cuisson se trouve à l'intérieur du plat.</p>	<p>Introduisez la pointe de la Sonde de cuisson exactement au centre du ragoût. La Sonde de cuisson doit être stabilisée en un seul endroit pendant la cuisson. Pour y parvenir, utilisez un ingrédient solide. Utilisez le bord du plat de cuisson pour soutenir la poignée en silicone de la Sonde de cuisson. La pointe de la Sonde de cuisson ne doit pas toucher le fond du plat de cuisson.</p>
	
<p>Étape 4</p>	<p>Branchez-la Sonde de cuisson dans la prise à l'avant du four. L'affichage indique la température actuelle de : Sonde de cuisson.</p>
<p>Étape 5</p>	<p> - appuyez pour régler la température à cœur du capteur.</p>
<p>Étape 6</p>	<p>OK - appuyez pour confirmer. Lorsque les aliments atteignent la température définie, un signal sonore retentit. Vous pouvez choisir d'arrêter ou de poursuivre la cuisson pour vous assurer que l'aliment est bien cuit.</p>
<p>Étape 7</p>	<p>Retirez la fiche de la Sonde de cuisson de la prise et retirez le plat du four.</p> <div style="border: 1px solid black; padding: 5px; margin-top: 10px;"> <p> AVERTISSEMENT! Attention au risque de brûlure car la Sonde de cuisson devient chaude. Faites attention en la débranchant et en la retirant de l'aliment.</p> </div>



10. FONCTIONS SUPPLÉMENTAIRES

10.1 Touches Verrouil.

Cette fonction permet d'éviter une modification involontaire de la fonction du four.		
<p>Activez-la lorsque le four est allumé - la cuisson réglée est maintenue, le bandeau de commande est verrouillé. Activez-la lorsque le four est éteint - le four ne peut pas être allumé, le bandeau de commande est verrouillé.</p>		
	<p> OK - maintenez la touche enfoncée pour activer la fonction. Un signal sonore retentit.</p>	<p> OK - maintenez la touche enfoncée pour la désactiver.</p>
<p> 3 x  - clignote lorsque le verrouillage est activé.</p>		

10.2 Arrêt automatique

Pour des raisons de sécurité, le four s'éteint au bout d'un certain temps si un mode de cuisson est en cours et vous ne modifiez aucun réglage.

 (°C)	 (h)
30 - 115	12.5
120 - 195	8.5
200 - 245	5.5
250 -maximum	3

L'arrêt automatique ne fonctionne pas avec les fonctions : Eclairage four, Sonde de cuisson, Départ différé.





10.3 Ventilateur de refroidissement

Lorsque le four fonctionne, le ventilateur de refroidissement se met automatiquement en marche pour refroidir les surfaces du four. Si vous éteignez le four, le ventilateur de refroidissement continue à fonctionner jusqu'à ce que le four refroidisse.





11. CONSEILS

11.1 Circulation d'air humide

Pour de meilleurs résultats, suivez les suggestions indiquées dans le tableau ci-dessous.



		 (°C)		 (min)
Petits pains su-crés, (16 pièces)	Plateau de cuisson ou plat à rôtir	180	2	20 - 30
Petits pains, (9 pièces)	Plateau de cuisson ou plat à rôtir	180	2	30 - 40
Pizza, surgelée, 0,35 kg	grille métallique	220	2	10 - 15
Gâteau Roulé	Plateau de cuisson ou plat à rôtir	170	2	25 - 35
Brownie	Plateau de cuisson ou plat à rôtir	175	3	25 - 30
Soufflé, (6 pièces)	ramequins en céramique sur une grille métallique	200	3	25 - 30
Fond de tarte en génoise	moule à tarte sur une grille métallique	180	2	15 - 25
Gâteau à étages	Plat de cuisson sur la grille métallique	170	2	40 - 50
Poisson poché, 0,3 kg	Plateau de cuisson ou plat à rôtir	180	3	20 - 25
Poisson entier, 0,2 kg	Plateau de cuisson ou plat à rôtir	180	3	25 - 35
Filet de poisson, 0,3 kg	plaque à pizza sur la grille métallique	180	3	25 - 30
Viande pochée, 0,25 kg	Plateau de cuisson ou plat à rôtir	200	3	35 - 45
Chachlyk, 0,5 kg	Plateau de cuisson ou plat à rôtir	200	3	25 - 30
Cookies, (16 pièces)	Plateau de cuisson ou plat à rôtir	180	2	20 - 30

CONSEILS

		 (°C)		 (min)
Meringues, (24 pièces)	Plateau de cuisson ou plat à rôtir	180	2	25 - 35
Muffins, (12 pièces)	Plateau de cuisson ou plat à rôtir	170	2	30 - 40
Petite pâtisserie salée, (20 pièces)	Plateau de cuisson ou plat à rôtir	180	2	25 - 30
Biscuits à pâte sablée, (20 pièces)	Plateau de cuisson ou plat à rôtir	150	2	25 - 35
Tartelettes, (8 pièces)	Plateau de cuisson ou plat à rôtir	170	2	20 - 30
Légumes, pochés, 0,4 kg	Plateau de cuisson ou plat à rôtir	180	3	35 - 45
Omelette végétarienne	plaque à pizza sur la grille métallique	200	3	25 - 30
Légumes méditerranéens, 0,7 kg	Plateau de cuisson ou plat à rôtir	180	4	25 - 30

11.2 Circulation d'air humide - accessoires recommandés

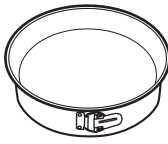

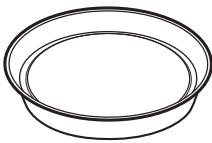



Utilisez les moules et récipients foncés et non réfléchissants. Ils offrent une meilleure absorption de la chaleur que les plats réfléchissants de couleur claire.

			
Plaque à pizza	Plat de cuisson	Ramequins	Moule pour fond de tarte
Sombre, non réfléchissant Diamètre de 28 cm	Sombre, non réfléchissant Diamètre de 26 cm	Céramique 8 cm de diamètre, 5 cm de hauteur	Sombre, non réfléchissant Diamètre de 28 cm







11.3 Tableaux de cuisson pour les instituts de tests







Informations pour les organismes de contrôle

Tests conformément à la norme IEC 60350-1.

				 (°C)	 (min)	
Petits gâteaux, 20 par plateau	Chauffage Haut/Bas	Plateau de cuisson	3	170	20 - 30	-
Petits gâteaux, 20 par plateau	Chaleur tournante	Plateau de cuisson	3	150 - 160	20 - 35	-
Petits gâteaux, 20 par plateau	Chaleur tournante	Plateau de cuisson	2 et 4	150 - 160	20 - 35	-
Tarte aux pommes, 2 moules Ø20 cm	Chauffage Haut/Bas	Grille métallique	2	180	70 - 90	-
Tarte aux pommes, 2 moules Ø20 cm	Chaleur tournante	Grille métallique	2	160	70 - 90	-
Génoise, moule à gâteau Ø26 cm	Chauffage Haut/Bas	Grille métallique	2	170	40 - 50	Préchauffez le four pendant 10 minutes.

CONSEILS

				 (°C)	 (min)	
Génoise, moule à gâteau Ø26 cm	Chaleur tournante	Grille métallique	2	160	40 - 50	Préchauffez le four pendant 10 minutes.
Génoise, moule à gâteau Ø26 cm	Chaleur tournante	Grille métallique	2 et 4	160	40 - 60	Préchauffez le four pendant 10 minutes.
Sablé	Chaleur tournante	Plateau de cuisson	3	140 - 150	20 - 40	-
Sablé	Chaleur tournante	Plateau de cuisson	2 et 4	140 - 150	25 - 45	-
Sablé	Chauffage Haut/Bas	Plateau de cuisson	3	140 - 150	25 - 45	-
Pain grillé, 4 à 6 morceaux	Gril	Grille métallique	4	max.	2 à 3 minutes sur la première face ; 2 à 3 minutes sur la seconde face.	Préchauffez le four pendant 3 minutes.

				 (°C)	 (min)	
Steak haché de bœuf, 6 pièces, 0,6 kg	Gril	Grille métallique et lèche-frite	4	max.	20 - 30	Placez la grille métallique sur le quatrième niveau et la lèche-frite sur le troisième niveau du four. Retournez les aliments à la moitié du temps de cuisson. Préchauffez le four pendant 3 minutes.



12. ENTRETIEN ET NETTOYAGE



AVERTISSEMENT!

Reportez-vous aux chapitres concernant la sécurité.

12.1 Remarques concernant l'entretien

 Agents nettoyants	Nettoyez la façade du four avec un chiffon doux, de l'eau tiède et un détergent doux.
	Utilisez une solution de nettoyage pour nettoyer les surfaces métalliques.
	Nettoyez les taches avec un détergent doux.
 Utilisation quotidienne	Nettoyez la cavité après chaque utilisation. L'accumulation de graisse ou d'autres résidus peut provoquer un incendie.
	De l'humidité peut se déposer dans l'enceinte du four ou sur les vitres de la porte. Pour diminuer la condensation, laissez fonctionner le four pendant 10 minutes avant la cuisson. Ne conservez pas les aliments dans le four pendant plus de 20 minutes. Sécher la cavité avec un chiffon doux après chaque utilisation.

ENTRETIEN ET NETTOYAGE

 Accessoires	Après chaque utilisation, lavez tous les accessoires et séchez-les. Utilisez un chiffon doux avec de l'eau tiède et un détergent doux. Ne lavez pas les accessoires au lave-vaisselle.
	Ne nettoyez pas les accessoires antiadhésifs avec un produit nettoyant abrasif ou des objets tranchants.

12.2 Comment enlever : Supports de grille

Retirez les supports de grille pour nettoyer le four.

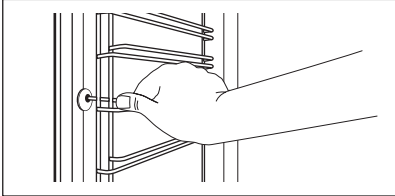
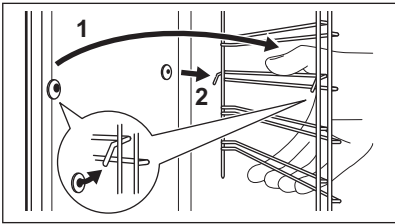
Étape 1	Éteignez le four et attendez qu'il soit froid.	
Étape 2	Écartez l'avant du support de grille de la paroi latérale.	
Étape 3	Écartez l'arrière du support de grille de la paroi latérale et retirez le support.	
Étape 4	Réinstallez les supports de grille en répétant cette procédure dans l'ordre inverse.	

12.3 Comment utiliser : Nettoyage par pyrolyse



Nettoyez le four avec Nettoyage par pyrolyse.

	AVERTISSEMENT! Risque de brûlure.
--	---

	ATTENTION! Si un autre appareil est installé dans le même meuble, ne l'utilisez pas en même temps que cette fonction. Vous risqueriez d'endommager le four.
--	---

Avant le Nettoyage par pyrolyse :

Éteignez le four et attendez qu'il soit froid.	Retirez les accessoires .	Nettoyez la sole du four et la vitre interne de la porte avec de l'eau tiède, un chiffon doux et un détergent doux.
--	---------------------------	---

Nettoyage par pyrolyse	
Étape 1	Ouvrez le menu : Nettoyage  .
Option	Durée
C1 - Nettoyage léger	1 h
C2 - Nettoyage normal	1 h 30 min
C3 - Nettoyage complet	2 h 30 min
Étape 2	OK - appuyez pour définir le programme de nettoyage.
Étape 3	OK - appuyez pour démarrer le nettoyage.
Étape 4	Après le nettoyage, tournez la manette des modes de cuisson sur la position Arrêt.
<p> Au cours du nettoyage, l'éclairage du four est éteint.</p> <p>Lorsque le four atteint la température réglée, la porte se verrouille. Jusqu'à ce que la porte se déverrouille, l'affichage indique : .</p>	

Une fois le nettoyage terminé :		
Éteignez le four et attendez qu'il soit froid.	Nettoyez la cavité avec un chiffon doux.	Retirez les résidus du fond de la cavité.

12.4 Nettoyage conseillé

Le four vous rappelle lorsque le nettoyage par pyrolyse est terminé.	
 clignote sur l'affichage pendant 5 secondes après chaque session de cuisson.	Pour désactiver le rappel, accédez au Menu et sélectionnez Configurations, Nettoyage conseillé.

12.5 Comment nettoyer : Réservoir d'eau





Étape 1	Éteignez le four.
---------	-------------------

ENTRETIEN ET NETTOYAGE

Étape 2	Placez un plat profond sous le tuyau d'arrivée de la vapeur.
Étape 3	Versez de l'eau dans le bac à eau : 850 ml. Ajoutez l'acide citrique : 5 cuillères à café. Attendez 60 min.
Étape 4	Allumez le four et réglez la fonction : Humidité faible. Réglez la température sur 230 °C. Éteignez le four au bout de 25 minutes et attendez qu'il refroidisse.
Étape 5	Allumez le four et réglez la fonction : Humidité faible. Réglez la température entre 130 et 230 °C. Éteignez le four au bout de 10 minutes et attendez qu'il refroidisse.
<p>i Pour empêcher la formation de résidus de calcaire, vidangez le réservoir d'eau après chaque cuisson à la vapeur.</p>	

Une fois le nettoyage terminé :			
Éteignez le four.	Vidangez le réservoir d'eau. Reportez-vous à Utilisation quotidienne, chapitre « Vidange du réservoir d'eau ».	Rincez le réservoir d'eau et nettoyez les résidus de calcaire restants avec un chiffon doux.	Nettoyez le tuyau de vidange avec de l'eau chaude et un détergent doux.

Le tableau ci-dessous indique la plage de dureté de l'eau (dH) avec le niveau correspondant de dépôt calcaire et la qualité de l'eau. Si la dureté de l'eau dépasse le niveau 4, remplissez le bac à eau avec de l'eau en bouteille.

Dureté de l'eau		Bandelette de test	Dépôt calcaire (mg/l)	Classification de l'eau	Nettoyez le réservoir d'eau tous les
Niveau	dH				
1	0 - 7		0 - 50	douce	75 cycles - 2,5 mois
2	8 - 14		51 - 100	modérément dure	50 cycles - 2 mois
3	15 - 21		101 - 150	dure	40 cycles - 1,5 mois
4	22 - 28		plus de 151	très dure	30 cycles - 1 mois

12.6 Comment démonter et installer : Porte

La porte du four est dotée de trois panneaux de verre. Vous pouvez retirer la porte du four ainsi que les panneaux de verre intérieurs afin de les nettoyer. Lisez toutes les instructions du chapitre « Retrait et installation de la porte » avant de retirer les panneaux de verre.



ATTENTION!

N'utilisez pas le four sans les panneaux en verre.

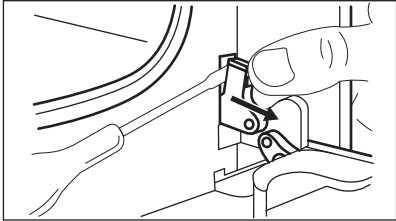
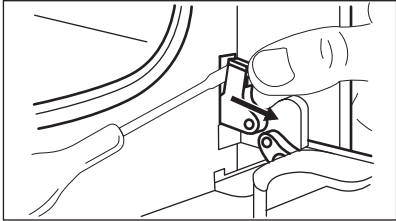
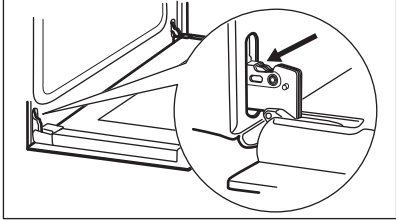
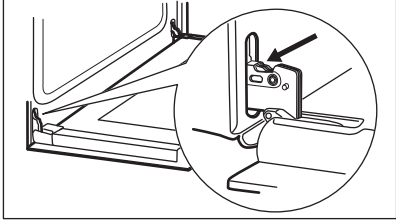
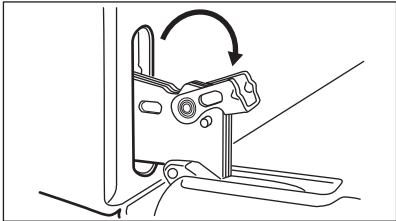
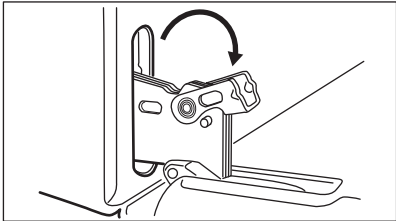
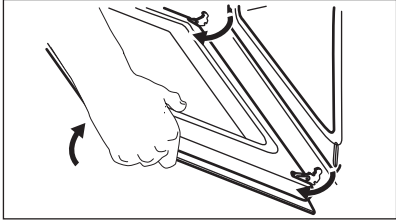
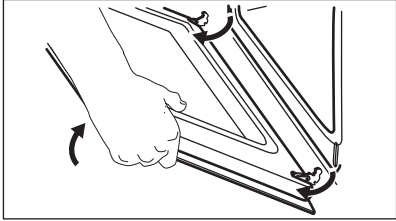
<p>Étape 1</p>	<p>Ouvrez la porte en grand et identifiez la charnière située à droite de la porte.</p>	
<p>Étape 2</p>	<p>Servez-vous d'un tournevis pour soulever et faire pivoter le levier de la charnière droite.</p>	
<p>Étape 3</p>	<p>Identifiez la charnière à gauche de la porte.</p>	
<p>Étape 4</p>	<p>Soulevez et faites complètement tourner le levier sur la charnière gauche.</p>	
<p>Étape 5</p>	<p>Fermez la porte du four à la première position d'ouverture (mi-parcours). Puis soulevez et tirez la porte vers l'avant et retirez-la de son logement.</p>	
<p>Étape 6</p>	<p>Déposez la porte sur une surface stable recouverte d'un tissu doux.</p>	
<p>Étape 7</p>	<p>Tenez la garniture de porte (B) sur le bord supérieur de la porte des deux côtés et poussez vers l'intérieur pour libérer le joint du clip.</p>	
<p>Étape 8</p>	<p>Tirez la garniture de porte vers l'avant pour la déposer.</p>	

ENTRETIEN ET NETTOYAGE

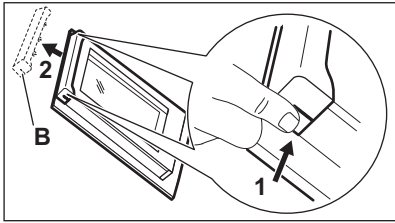
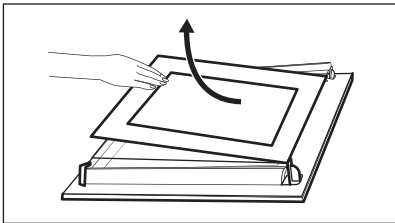
Étape 9	Prenez les panneaux de verre de la porte par leur bord supérieur et tirez-les doucement, un par un. Commencez par le panneau supérieur. Assurez-vous que la vitre glisse entièrement hors de ses supports.	
Éta-pe 10	Nettoyez les panneaux de verre avec de l'eau savonneuse. Séchez soigneusement les panneaux de verre. Ne nettoyez pas les panneaux de verre au lave-vaisselle.	
Éta-pe 11	Après le nettoyage, installez les panneaux de verre et la porte du four.	

Veillez à replacer les panneaux de verre (A et B) dans le bon ordre. Cherchez le symbole / l'impression se trouvant sur le côté du panneau de verre. Tous les panneaux ont un symbole différent pour faciliter le démontage et le montage.

Lorsque le cadre de la porte est installé correctement, il émet un clic.

Veillez à installer correctement le panneau de verre du milieu dans son logement.

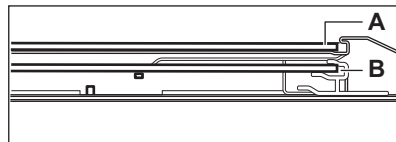
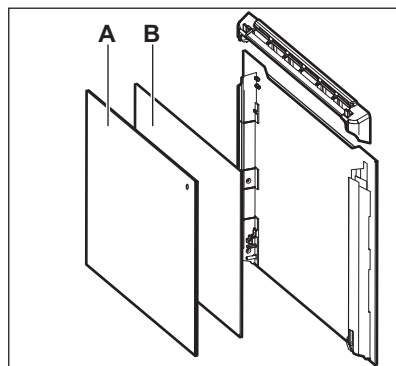

12.7 Comment remplacer : Éclairage



AVERTISSEMENT!

Risque d'électrocution.

L'éclairage peut être chaud.

Tenez toujours l'ampoule halogène avec un chiffon afin d'éviter que des résidus de graisse ne brûlent sur l'ampoule.

Avant de remplacer l'éclairage :

Étape 1	Étape 2	Étape 3
Éteignez le four. Attendez que le four ait refroidi.	Débranchez le four de l'alimentation secteur.	Placez un chiffon au fond de la cavité.

Lampe arrière

Étape 1	Tournez le diffuseur en verre pour le retirer.
Étape 2	Nettoyez le diffuseur en verre.
Étape 3	Remplacez l'éclairage par une ampoule adaptée résistant à une température de 300 °C.
Étape 4	Remettez en place le diffuseur en verre.

13. DÉPANNAGE



AVERTISSEMENT!

Reportez-vous aux chapitres concernant la sécurité.

13.1 Que faire si...

Dans tous les cas ne figurant pas dans ce tableau, veuillez contacter un service après-vente agréé.

Le four ne s'allume pas ou ne chauffe pas	
Problème	Vérifiez si...
Vous ne pouvez pas activer la table de cuisson ni la faire fonctionner.	Le four est correctement branché à l'alimentation électrique.
Le four ne chauffe pas.	L'arrêt automatique est désactivé.
Le four ne chauffe pas.	La porte du four est fermée.
Le four ne chauffe pas.	Le fusible n'a pas disjoncté.
Le four ne chauffe pas.	La Sécurité enfants est désactivée.

DÉPANNAGE

Composants	
Problème	Vérifiez si...
L'éclairage est éteint.	La Circulation d'air humide est activée.
L'éclairage ne fonctionne pas.	L'ampoule est grillée.
La Sonde de cuisson ne fonctionne pas.	La fiche de la Sonde de cuisson est complètement insérée dans la prise.

Codes d'erreur	
L'affichage indique...	Vérifiez si...
Err C2	Vous avez retiré la fiche de la Sonde de cuisson de la prise.
Err C3	La porte du four est fermée ou le verrouillage de la porte n'est pas cassé.
Err F102	La porte du four est fermée.
Err F102	Le verrouillage de la porte n'est pas cassé.
0:00.	Une coupure de courant s'est produite. Réglez l'heure actuelle.
Si l'affichage indique un code d'erreur qui ne figure pas dans ce tableau, désactivez et réenclenchez le fusible de l'habitation pour redémarrer le four. Si le code d'erreur réapparaît, contactez un service après-vente agréé.	

Nettoyage	
Problème	Vérifiez si...
De l'eau est présente dans la cavité du four.	Le réservoir d'eau n'est pas trop rempli.
Le voyant  est éteint.	Le réservoir d'eau est assez rempli. Si de l'eau commence à fuir dans le four et que le voyant est toujours éteint, contactez un service après-vente agréé.

Nettoyage	
Le voyant  est allumé.	Il y a assez d'eau dans le réservoir. Si le réservoir est plein et que le voyant est toujours allumé, contactez un service après-vente agréé.
La cuisson à la vapeur ne fonctionne pas.	Il n'y a aucun résidu de calcaire dans l'ouverture du tuyau d'arrivée de la vapeur.
La cuisson à la vapeur ne fonctionne pas.	De l'eau est présente dans le réservoir d'eau.
Il faut plus de trois minutes pour vidanger le réservoir d'eau ou l'eau fuit de l'ouverture du tuyau d'arrivée de la vapeur.	Il n'y a aucun résidu de calcaire dans l'ouverture du tuyau d'arrivée de la vapeur. Nettoyez le réservoir de l'eau.

13.2 Données de maintenance

Si vous ne trouvez pas de solution au problème, veuillez contacter votre revendeur ou un service après-vente agréé.

Les informations nécessaires au service après-vente figurent sur la plaque signalétique. La plaque signalétique se trouve sur le cadre avant de la cavité du four. Ne retirez pas la plaque signalétique de la cavité du four.

Nous vous recommandons d'écrire les informations ici :	
Modèle (Mod.)
Référence produit (PNC)
Numéro de série (S.N.)

14. RENDEMENT ÉNERGÉTIQUE

14.1 Informations produit et Fiche d'informations produit*

Nom du fournisseur	AEG
Identification du modèle	BSB578270M 949494787 BSE578270M 949494772 BSS57807BM 949494790 BSS578270M 949494786
Index d'efficacité énergétique	81.2

RENDEMENT ÉNERGÉTIQUE

Classe d'efficacité énergétique	A+	
Consommation d'énergie avec charge standard et mode traditionnel	0.93 kWh/cycle	
Consommation d'énergie avec charge standard et mode air pulsé	0.69 kWh/cycle	
Nombre de cavités	1	
Source de chaleur	Électricité	
Volume	72 l	
Type de four	Four encastrable	
Masse	BSB578270M	33.7 kg
	BSE578270M	32.9 kg
	BSS57807BM	34.8 kg
	BSS578270M	33.8 kg

* Pour l'Union européenne conformément aux Règlements UE 65/2014 et 66/2014.
Pour la République de Biélorussie conformément à STB 2478-2017, Annexe G ; STB 2477-2017, Annexes A et B.
Pour l'Ukraine conformément à 568/32020.

La classe d'efficacité énergétique n'est pas applicable pour la Russie.

EN 60350-1 - Appareils de cuisson domestiques électriques - Partie 1 : Plages, fours, fours à vapeur et grils - Méthodes de mesure des performances.

14.2 Économie d'énergie



Ce four est doté de caractéristiques qui vous permettent d'économiser de l'énergie lors de votre cuisine au quotidien.

Lorsque le four est en marche, assurez-vous que la porte est bien fermée. Évitez d'ouvrir la porte trop souvent pendant la cuisson. Nettoyez régulièrement le joint de porte et assurez-vous qu'il est bien en place.

Utilisez des plats en métal pour accroître les économies d'énergie.

Dans la mesure du possible, ne préchauffez pas le four avant la cuisson.

Lorsque vous préparez plusieurs plats à la fois, faites en sorte que les pauses entre les cuissons soient aussi courtes que possible.

Cuisson avec ventilation

Si possible, utilisez les fonctions de cuisson avec la ventilation pour économiser de l'énergie.

Chaleur résiduelle

L'éclairage et le ventilateur continuent de fonctionner. Lorsque vous éteignez le four, l'affichage montre la chaleur résiduelle. Vous pouvez utiliser cette chaleur pour le maintien au chaud des aliments.

Si la cuisson doit durer plus de 30 minutes, réduisez la température du four au minimum 3 à 10 minutes avant la fin de la cuisson. La chaleur résiduelle à l'intérieur du four poursuivra la cuisson.

Utilisez la chaleur résiduelle pour réchauffer d'autres plats.

Maintien des aliments au chaud

Sélectionnez la température la plus basse possible pour utiliser la chaleur résiduelle et maintenir le repas au chaud. La température ou le voyant de chaleur résiduelle s'affichent.

Cuisson avec l'éclairage éteint

Éteignez l'éclairage en cours de cuisson. Ne l'allumez que lorsque vous en avez besoin.

Circulation d'air humide



Fonction conçue pour économiser de l'énergie en cours de cuisson.







Lorsque vous utilisez cette fonction, l'éclairage s'éteint automatiquement au bout de 30 secondes. Vous pouvez rallumer l'éclairage, mais cela réduira les économies d'énergie.

15. STRUCTURE DES MENUS

15.1 Menu

	☰ - sélectionnez pour accéder au Menu .
---	---



Structure du Menu		
Cuisson assistée 	Nettoyage 	Configurations 

Étape 1	Étape 2	Étape 3	Étape 4	Étape 5
  	 OK	 O1 -O15	 OK	
Sélectionnez le Menu , Configurations.	Confirmez la configuration.	Sélectionnez la configuration.	Confirmez la configuration.	Ajustez la valeur et appuyez sur OK.

STRUCTURE DES MENUS

Configurations					
O1	Heure actuelle	Modifier	O2	Affichage Luminosité	1 - 5
O3	Son touches	1 - Bip 2 - Clic 3 - Son dés-activé	O4	Volume alarme	1 - 4
O5	Action Sonde de cuisson	1 - Alarme et arrêt 2 - Alarme	O6	Compteur	Marche / Arrêt
O7	Eclairage four	Marche / Arrêt	O8	Préchauffage rapide	Marche / Arrêt
O9	Nettoyage conseillé	Marche / Arrêt	O10	Wi-Fi :	Marche / Arrêt
O11	Fonctionnement à distance automatique	Marche / Arrêt	O12	Ignorer Réseau	Oui/Non
O13	Mode démo	Code d'activation : 2468	O14	Version du logiciel	Contrôle
O15	Réinitialiser tous les réglages	Oui/Non			

16. EN MATIÈRE DE PROTECTION DE L'ENVIRONNEMENT

Recyclez les matériaux portant le symbole . Déposez les emballages dans les conteneurs prévus à cet effet. Contribuez à la protection de l'environnement et à votre sécurité, recyclez vos produits électriques et électroniques. Ne jetez pas les appareils portant le symbole  avec les ordures ménagères. Emmenez un tel produit dans votre centre local de recyclage ou contactez vos services municipaux.

PER RISULTATI PERFETTI

Grazie per aver scelto di acquistare questo prodotto AEG. Lo abbiamo creato per fornirvi prestazioni impeccabili per molti anni, grazie a tecnologie innovative che vi semplificheranno la vita - funzioni che non troverete sulle normali apparecchiature. Vi invitiamo di dedicare qualche minuto alla lettura per sapere come trarre il massimo dal vostro elettrodomestico. Visitate il nostro sito web per:



Ricevere consigli, scaricare i nostri opuscoli, eliminare eventuali anomalie, ottenere informazioni sull'assistenza e la riparazione:

www.aeg.com/support



Per registrare il vostro prodotto e ricevere un servizio migliore:

www.registreaeg.com



Acquistare accessori, materiali di consumo e ricambi originali per la vostra apparecchiatura:

www.aeg.com/shop



Per ulteriori ricette, suggerimenti, indicazioni per la risoluzione dei problemi scaricare l'app **My AEG Kitchen**.



ASSISTENZA CLIENTI E ASSISTENZA TECNICA

Consigliamo sempre l'impiego di ricambi originali.

Quando si contatta il nostro Centro di Assistenza Autorizzato, accertarsi di avere a disposizione i dati seguenti: Modello, numero dell'apparecchio (PNC), numero di serie.

Le informazioni sono riportate sulla targhetta identificativa.

 Avvertenza/Attenzione - Importanti Informazioni per la sicurezza

 Informazioni generali e suggerimenti

 Informazioni ambientali

Con riserva di modifiche.

INDICE

1. INFORMAZIONI DI SICUREZZA.....	139	2.7 Illuminazione interna.....	145
1.1 Sicurezza di bambini e persone vulnerabili.....	139	2.8 Assistenza.....	145
1.2 Avvertenze di sicurezza generali.	140	2.9 Smaltimento.....	146
2. ISTRUZIONI DI SICUREZZA.....	141	3. INSTALLAZIONE.....	146
2.1 Installazione.....	141	3.1 Incasso.....	146
2.2 Collegamento elettrico.....	142	3.2 Fissaggio nel mobile.....	147
2.3 Utilizzo:.....	143	4. DESCRIZIONE DEL PRODOTTO.....	148
2.4 Pulizia e cura.....	144	4.1 Panoramica generale.....	148
2.5 Pulizia pirolitica.....	144	4.2 Accessori.....	148
2.6 Cottura a vapore.....	145		

5. COME ACCENDERE E SPEGNERE IL FORNO.....	149	11. CONSIGLI E SUGGERIMENTI UTILI....	166
5.1 Manopola incassabile.....	149	11.1 Cottura ventilata umida.....	166
5.2 Pannello dei comandi.....	149	11.2 Cottura ventilata umida - accessori consigliati.....	168
6. PRIMA DEL PRIMO UTILIZZO.....	150	11.3 Tabelle di cottura per gli istituti di test.....	169
6.1 Pulizia iniziale.....	150	12. PULIZIA E CURA.....	170
6.2 Preriscaldamento iniziale.....	150	12.1 Note sulla pulizia.....	171
6.3 Connessione wireless 	151	12.2 Come togliere: Supporti ripiano	171
6.4 Licenze software.....	152	12.3 Istruzioni d'uso: Pulizia per pirolisi.....	172
7. UTILIZZO QUOTIDIANO.....	152	12.4 Promemoria Pulizia.....	173
7.1 Come impostare: Funzioni cottura.....	152	12.5 Come eseguire la pulizia: Serbatoio dell'acqua.....	173
7.2 Funzioni cottura.....	153	12.6 Come rimuovere e installare: Porta.....	174
7.3 Note su: Cottura ventilata umida.	154	12.7 Come sostituire: Lampadina.....	176
7.4 Serbatoio dell'acqua.....	154	13. RISOLUZIONE DEI PROBLEMI.....	177
7.5 Come impostare: Cottura guidata	155	13.1 Cosa fare se.....	177
7.6 Cottura guidata con ricette.....	156	13.2 Dati dell'Assistenza.....	179
8. FUNZIONI DEL TIMER.....	161	14. EFFICIENZA ENERGETICA.....	179
8.1 Funzioni orologio.....	161	14.1 Informazioni sul prodotto e Scheda informativa sul prodotto*.....	179
8.2 Come impostare: Funzioni Orologio.....	161	14.2 Risparmio energetico.....	180
9. COME USARLE: ACCESSORI.....	163	15. STRUTTURA DEL MENU.....	181
9.1 Inserimento di accessori.....	163	15.1 Menu.....	181
9.2 Termosonda.....	164	16. CONSIDERAZIONI SULL'AMBIENTE..	182
10. FUNZIONI AGGIUNTIVE.....	166		
10.1 Blocco.....	166		
10.2 Spegnimento automatico.....	166		
10.3 Ventola di raffreddamento.....	166		



1. ⚠️ INFORMAZIONI DI SICUREZZA

Leggere attentamente le istruzioni fornite prima di installare e utilizzare l'apparecchiatura. I produttori non sono responsabili di eventuali lesioni o danni derivanti da un'installazione o un uso scorretti. Conservare sempre le istruzioni in un luogo sicuro e accessibile per poterle consultare in futuro.

1.1 Sicurezza di bambini e persone vulnerabili

- Quest'apparecchiatura può essere usata da bambini a partire da 8 anni di età e da adulti con capacità fisiche, sensoriali o mentali limitate o con scarsa esperienza e conoscenza sull'uso dell'apparecchiatura, solamente se sorvegliati o se istruiti relativamente all'utilizzo in sicurezza dell'apparecchiatura e se hanno compreso i rischi coinvolti. I bambini che hanno meno di 8 anni e le persone con disabilità diffuse e complesse vanno tenuti lontani dall'elettrodomestico, a meno che non vi sia una supervisione continua.

- I bambini devono essere sorvegliati per assicurarsi che non giochino con l'apparecchiatura e i dispositivi mobili con My AEG Kitchen.
- Tenere gli imballaggi lontano dai bambini e smaltirli in modo adeguato.
- **AVVERTENZA:** Tenere i bambini e gli animali domestici lontani dall'elettrodomestico durante il funzionamento o il raffreddamento. Le parti accessibili si riscaldano molto durante l'uso.
- Se l'elettrodomestico ha un dispositivo di sicurezza per i bambini sarà opportuno attivarlo.
- I bambini non devono eseguire interventi di pulizia e manutenzione sull'elettrodomestico senza essere supervisionati.

1.2 Avvertenze di sicurezza generali

- L'installazione dell'apparecchiatura e la sostituzione dei cavideve essere effettuata unicamente da personale qualificato.
- Non utilizzare l'apparecchiatura prima di installarla nella struttura a incasso.
- Prima di ogni operazione di manutenzione, scollegare l'apparecchiatura dall'alimentazione elettrica.
- Se il cavo di alimentazione è danneggiato, deve essere sostituito dal produttore, da un centro di assistenza tecnica autorizzato o da una persona qualificata per evitare situazioni di pericolo elettrico.
- **AVVERTENZA:** Assicurarsi che l'elettrodomestico sia spento prima di sostituire la lampadina per evitare la possibilità di scosse elettriche.
- **AVVERTENZA:** L'elettrodomestico e le parti accessibili si riscaldano molto durante l'uso. Fare attenzione a non toccare gli elementi riscaldanti.
- Utilizzare sempre guanti da forno per rimuovere o collocare accessori o pirofile.

- Usare esclusivamente la termosonda (sensore temperatura al centro) consigliata per questa apparecchiatura.
- Per rimuovere i supporti del ripiano, tirare prima la parte anteriore del supporto del ripiano e poi l'estremità posteriore lontano dalle pareti laterali. Installare i supporti ripiani seguendo al contrario la procedura indicata.
- Non utilizzare vaporelle per pulire l'elettrodomestico.
- Non utilizzare detergenti abrasivi o raschietti di metallo per pulire il vetro dello sportello per non rigare la superficie e causare la rottura del vetro.
- Una fuoriuscita eccessiva deve essere rimossa prima di avviare la pulizia per pirolisi. Togliere tutte le parti dal forno.

2. ISTRUZIONI DI SICUREZZA

2.1 Installazione



AVVERTENZA!

L'installazione dell'apparecchiatura deve essere eseguita da personale qualificato.

- Rimuovere tutti i materiali di imballaggio.
- Non installare o utilizzare l'apparecchiatura se è danneggiata.
- Attenersi alle istruzioni fornite insieme all'apparecchiatura.
- Prestare sempre attenzione in fase di spostamento dell'apparecchiatura, dato che è pesante. Usare sempre i guanti di sicurezza e le calzature adeguate.
- Non tirare l'apparecchiatura per la maniglia.
- Installare l'apparecchiatura in un luogo sicuro e idoneo che soddisfi i requisiti di installazione.
- È necessario rispettare la distanza minima dalle altre apparecchiature.
- Prima di montare l'apparecchiatura controllare che la porta del forno si apra senza limitazioni.
- L'apparecchiatura è dotata di un sistema di raffreddamento elettrico. Quest'ultimo funziona a corrente elettrica.

Altezza minima del mobiletto (mobiletto sotto all'altezza minima del piano di lavoro)	590 (600) mm
Larghezza del mobiletto	560 mm
Profondità del mobiletto	550 (550) mm
Altezza della parte anteriore dell'apparecchiatura	594 mm

ISTRUZIONI DI SICUREZZA

Altezza della parte posteriore dell'apparecchiatura	576 mm
Larghezza della parte anteriore dell'apparecchiatura	595 mm
Larghezza della parte posteriore dell'apparecchiatura	559 mm
Profondità dell'apparecchiatura	569 mm
Profondità di incasso dell'apparecchiatura	548 mm
Profondità con porta aperta	1022 mm
Dimensioni minime dell'apertura di ventilazione. Apertura collocata sul lato posteriore inferiore	560x20 mm
Lunghezza del cavo di alimentazione. Il cavo è collocato nell'angolo destro del lato posteriore	1500 mm
Viti di montaggio	4x25 mm

2.2 Collegamento elettrico



AVVERTENZA!

Rischio di incendio e scossa elettrica.

- Tutti i collegamenti elettrici devono essere realizzati da un elettricista qualificato.
- L'apparecchiatura deve disporre di una messa a terra.
- Verificare che i parametri sulla targhetta siano compatibili con le indicazioni elettriche dell'alimentazione.
- Utilizzare sempre una presa elettrica con contatto di protezione correttamente installata.
- Non utilizzare prese multiple e prolunghie.
- Accertarsi di non danneggiare la spina e il cavo. Qualora il cavo elettrico debba essere sostituito, l'intervento dovrà essere effettuato dal nostro Centro di Assistenza autorizzato.
- Evitare che i cavi entrino a contatto o si trovino vicino alla porta dell'apparecchiatura o sulla nicchia sotto all'apparecchiatura, in particolare quando il dispositivo è in funzione o la porta è calda.
- I dispositivi di protezione da scosse elettriche devono essere fissati in modo tale da non poter essere disattivati senza l'uso di attrezzi.
- Inserire la spina di alimentazione nella presa solo al termine dell'installazione. Verificare che la spina di alimentazione rimanga accessibile dopo l'installazione.
- Nel caso in cui la spina di corrente sia allentata, non collegarla alla presa.
- Non tirare il cavo di alimentazione per scollegare l'apparecchiatura. Tirare sempre dalla spina.
- Servirsi unicamente di dispositivi di isolamento adeguati: interruttori automatici, fusibili (quelli a tappo devono essere rimossi dal portafusibile), sganciatori per correnti di guasto a terra e relè.

- L'impianto elettrico deve essere dotato di un dispositivo di isolamento che consenta di scollegare l'apparecchiatura dalla presa di corrente a tutti i poli. Il dispositivo di isolamento deve avere una larghezza dell'apertura di contatto non inferiore ai 3 mm.
- Chiudere completamente la porta dell'apparecchiatura prima di collegare spina alla presa elettrica.
- La dotazione standard dell'apparecchiatura al momento della fornitura prevede una spina e un cavo di rete.

Tipi di cavi disponibili per l'installazione o la sostituzione per l'Europa:

H07 RN-F, H05 RN-F, H05 RRF, H05 VV-F, H05 V2V2-F (T90), H05 BB-F

Per la sezione del cavo, fare riferimento alla potenza totale sulla targhetta dei dati. È anche possibile consultare la tabella:

Potenza totale (W)	Sezione del cavo (mm ²)
massimo 1.380	3 x 0.75
massimo 2.300	3 x 1
massimo 3.680	3 x 1.5

Il cavo di terra (verde/giallo) deve essere 2 cm più lungo dei cavi di fase e neutro (blu e marrone).

2.3 Utilizzo:



AVVERTENZA!

Rischio di lesioni, ustioni, scosse elettriche o esplosioni.

- Quest'apparecchiatura è destinata esclusivamente all'uso domestico (al chiuso).
- Non modificare le specifiche tecniche dell'apparecchiatura.
- Assicurarsi che le aperture di ventilazione non siano bloccate.
- Non lasciare l'elettrodomestico incustodito durante il funzionamento.
- Spegnerlo l'elettrodomestico dopo ogni utilizzo.
- Prestare attenzione in fase di apertura dello sportello dell'elettrodomestico, quando quest'ultimo è in funzione. Può esservi un rilascio di aria calda.
- Non accendere l'elettrodomestico con le mani bagnate o quando è a contatto con l'acqua.
- Non esercitare pressione sullo sportello aperto.
- Non utilizzare l'elettrodomestico come superficie di lavoro o come superficie di deposito.
- Aprire lo sportello dell'elettrodomestico attentamente. L'utilizzo di ingredienti con alcol può provocare una miscela di alcol e aria.
- Non lasciare scintille o fiamme libere a contatto con l'elettrodomestico quando si apre lo sportello.
- Non appoggiare o tenere liquidi o materiali infiammabili, né oggetti facilmente infiammabili sull'apparecchiatura, al suo interno o nelle immediate vicinanze.
- Non condividere la password della propria rete Wi-Fi.



AVVERTENZA!

Vi è il rischio di danneggiare l'apparecchiatura.

- Per evitare danni o lo scolorimento dello smalto:
 - Non collocare pirofile o altri oggetti all'interno dell'elettrodomestico direttamente sul fondo.
 - Non collocare la pellicola di alluminio direttamente sul fondo della cavità dell'elettrodomestico.
 - Non versare acqua direttamente all'interno dell'elettrodomestico caldo.
 - Non conservare piatti e alimenti umidi all'interno dell'elettrodomestico dopo aver terminato la cottura.
 - Prestare attenzione in fase di rimozione o installazione degli accessori.
- Lo scolorimento dello smalto o dell'acciaio inox non influisce sulle prestazioni dell'elettrodomestico.
- Usare una leccarda per torte umide. I succhi di frutta causano macchie che possono essere permanenti.
- L'apparecchiatura è destinata solo alla cottura. Non deve essere utilizzata per altri scopi, ad esempio per riscaldare la stanza.
- Eseguire sempre la cottura con lo sportello del forno chiuso.
- Se l'apparecchiatura si trova dietro a un pannello anteriore (ad es. una porta), assicurarsi che questo non sia mai chiuso quando l'apparecchiatura è in funzione. Calore e umidità possono accumularsi sul retro di un pannello chiuso causando danni all'apparecchiatura, all'alloggiamento o al pavimento. Dopo l'uso non chiudere il pannello dell'armadio finché l'apparecchiatura non si è completamente raffreddata.

2.4 Pulizia e cura



AVVERTENZA!

Vi è il rischio di lesioni, incendio o danni all'apparecchiatura.

- Prima di eseguire qualunque intervento di manutenzione, spegnere l'apparecchiatura ed estrarre la spina dalla presa.
- Controllare che l'apparecchiatura sia fredda. Vi è il rischio che i pannelli in vetro si rompano.
- Sostituire immediatamente i pannelli in vetro della porta nel caso in cui siano danneggiati. Contattare il Centro Assistenza Autorizzato.
- Prestare attenzione quando si rimuove la porta dall'apparecchio. La porta è pesante!
- Pulire regolarmente l'apparecchiatura per evitare il deterioramento dei materiali che compongono la superficie.
- Pulire l'apparecchiatura con un panno inumidito e morbido. Utilizzare solo detergenti neutri. Non usare prodotti abrasivi, spugnette abrasive, solventi od oggetti metallici.
- Se si utilizza uno spray per il forno, seguire attentamente le istruzioni di sicurezza sulla confezione.

2.5 Pulizia pirolitica



AVVERTENZA!

Rischio di lesioni/Incendi/Emissioni chimiche (Fumi) in Modalità Pirolitica.

- Prima di eseguire una funzione di pulizia automatica per Pirolisi o prima del Primo Utilizzo, rimuovere dalla cavità del forno:
 - qualsiasi residuo di cibo e schizzo/deposito di grasso.

- qualsiasi oggetto rimovibile (compresi ripiani, guide ecc. forniti con il prodotto), in particolare qualsiasi pentola, padella, teglia, utensile antiaderente ecc.
- Leggere attentamente tutte le istruzioni riguardanti la pulizia per Pirolisi.
- Tenere bambini lontano dall'apparecchiatura mentre è in corso la pulizia pirolitica. L'apparecchiatura diventa molto calda e viene rilasciata aria calda dalle aperture di raffreddamento anteriori.
- La pulizia per pirolisi è un'operazione ad alta temperatura che può provocare la formazione di fumi prodotti dai residui di cottura e dai materiali strutturali, di conseguenza gli utenti sono fortemente invitati a:
 - assicurare una buona ventilazione durante e dopo ogni pulizia per Pirolisi.
 - assicurare una buona ventilazione durante e dopo il primo utilizzo alla massima temperatura.
- A differenza delle persone, alcune specie di uccelli e rettili possono essere estremamente sensibili ai fumi che possono venire prodotti durante il processo di pulizia dei Forni Pirolitici.
 - Allontanare eventuali animali domestici (in particolare gli uccelli) dall'apparecchiatura durante e dopo la pulizia per Pirolisi e prevedere prima di tutto un funzionamento alla massima temperatura in un'area ben ventilata.
- I piccoli animali domestici sono anche estremamente sensibili alle variazioni di temperatura in prossimità dei Forni Pirolitici quando il programma di pulizia automatica per Pirolisi è in corso.
- Superfici antiaderenti di pentole, teglie, utensili, ecc., possono venire danneggiate dall'alta temperatura utilizzata per la pulizia per Pirolisi in tutti i Forni Pirolitici e diventare fonte di vapori relativamente nocivi.
- I vapori rilasciati da tutti i Forni Pirolitici/Residui di Cottura vengono definiti come non nocivi per la salute umana, compresi bambini o persone affette da malattie.

2.6 Cottura a vapore



AVVERTENZA!

Vi è il rischio di ustioni o di danni all'apparecchiatura.

- Il vapore che fuoriesce può provocare ustioni:
 - Non aprire la porta dell'apparecchiatura durante la cottura a vapore.
 - Dopo aver impiegato la cottura al vapore aprire la porta dell'apparecchiatura con cautela.

2.7 Illuminazione interna



AVVERTENZA!

Pericolo di scosse elettriche.

- Per quanto riguarda la lampada o le lampade all'interno di questo prodotto e le lampade di ricambio vendute separatamente: Queste lampade sono destinate a resistere a condizioni fisiche estreme negli elettrodomestici, come temperatura, vibrazioni, umidità, o sono destinate a segnalare informazioni sullo stato operativo dell'apparecchio. Non sono destinate ad essere utilizzate in altre applicazioni e non sono adatte per l'illuminazione di ambienti domestici.
- Servirsi unicamente di lampadine con le stesse specifiche tecniche .

2.8 Assistenza

- Per far riparare l'apparecchiatura, rivolgersi a un Centro di Assistenza Autorizzato.
- Utilizzare solo ricambi originali.

INSTALLAZIONE

2.9 Smaltimento



AVVERTENZA!

Rischio di lesioni o soffocamento.

- Contattare le autorità locali per ricevere informazioni su come smaltire correttamente l'apparecchiatura.
- Staccare la spina dall'alimentazione elettrica.
- Tagliare il cavo elettrico dell'apparecchiatura e smaltirlo.
- Togliere il blocco porta per evitare che bambini, o animali restino intrappolati nell'apparecchiatura.

3. INSTALLAZIONE



AVVERTENZA!

Fare riferimento ai capitoli sulla sicurezza.

3.1 Incasso



YouTube

www.youtube.com/electrolux
www.youtube.com/aeg

How to install your AEG/Electrolux
Oven - Column installation

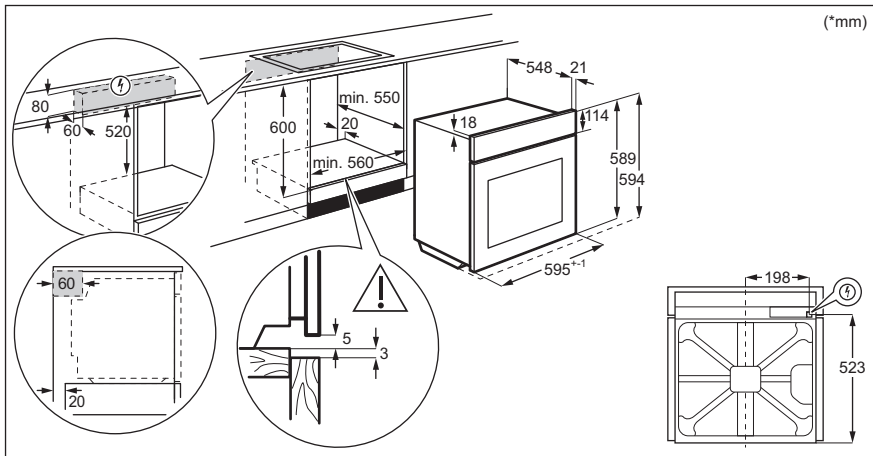

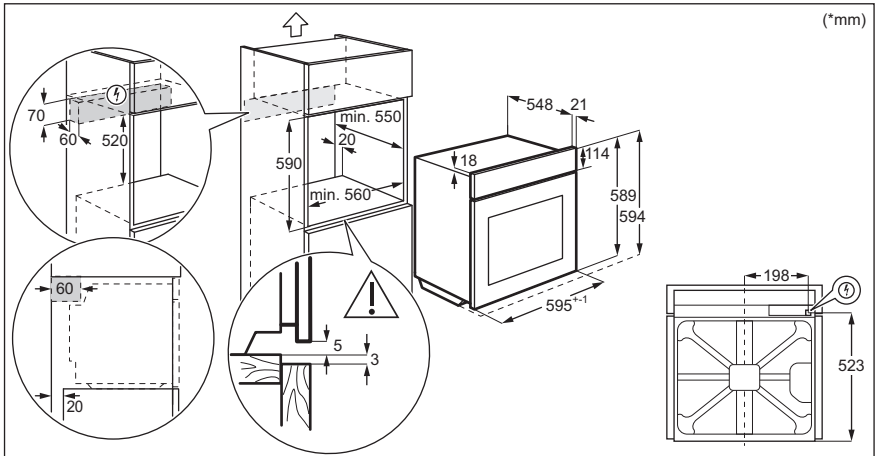

3.2 Fissaggio nel mobile

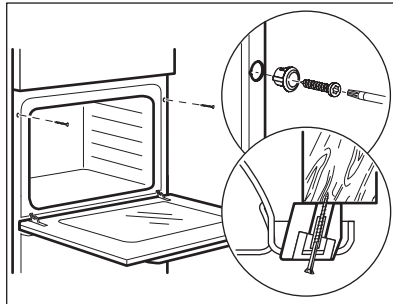

4. DESCRIZIONE DEL PRODOTTO

4.1 Panoramica generale

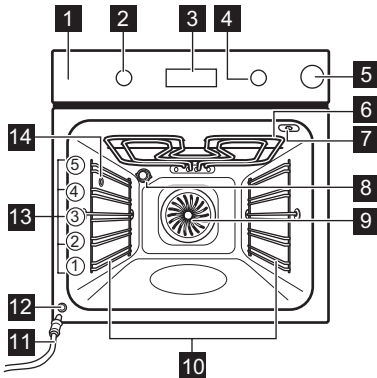

- 1** Pannello dei comandi
- 2** Manopola di regolazione delle funzioni cottura
- 3** Display
- 4** Manopola di regolazione
- 5** Vaschetta dell'acqua
- 6** Resistenza
- 7** Presa per la termosonda
- 8** Lampadina
- 9** Ventola
- 10** Supporto ripiano, rimovibile
- 11** Tubo di scarico
- 12** Valvola di scarico dell'acqua
- 13** Posizioni ripiano
- 14** Foro di entrata vapore

4.2 Accessori







- **Ripiano a filo**
Per stoviglie, stampi per dolci, arrostiti.
- **Lamiera dolci**
Per torte e biscotti.
- **Leccarda**
Per cuocere al forno e arrostitire o per raccogliere il grasso.
- **Sensore alimenti**
Per misurare il livello di cottura degli alimenti.

5. COME ACCENDERE E SPEGNERE IL FORNO





5.1 Manopola incassabile

Per utilizzare l'apparecchiatura, premere la manopola. La manopola fuoriesce.

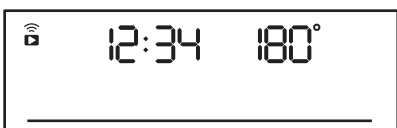
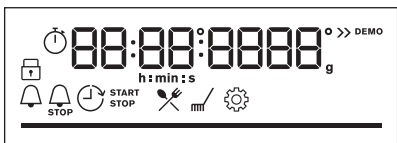





5.2 Pannello dei comandi

Tasti sensore pannello dei comandi					Premere	Ruotare la manopola
 Timer	 Riscaldamento rapido	 Luce forno	 Sensore alimenti	OK		
Selezionare una funzione cottura per accendere il forno.						
Per spegnere il forno, ruotare la manopola delle funzioni di riscaldamento fino a portarla in posizione off.						



	Quando la manopola delle funzioni di riscaldamento è in posizione off, il display passa in modalità standby.
	Quando si cucina, il display mostra la temperatura impostata, l'ora del giorno e le altre opzioni disponibili.
	Il display col numero massimo di funzioni impostate.

Spie display				
 Blocco	 Cottura guidata	 Pulizia	 Impostazioni	 Riscaldamento rapido

PRIMA DEL PRIMO UTILIZZO

Spie timer:				
Wi-Fi indicatore - lampeggia quando il forno può essere connesso al Wi-Fi.		Operazione da remoto indicatore - il forno può essere controllato in modalità remota.		
 Wi-Fi la connessione è attiva.		 Operazione da remoto è acceso.		

Barra di avanzamento - per temperatura o tempo.	
--	---





Indicatori del serbatoio d'acqua		
		

Termosonda indicatore	
------------------------------	---

6. PRIMA DEL PRIMO UTILIZZO

	AVVERTENZA! Fare riferimento ai capitoli sulla sicurezza.
--	---

6.1 Pulizia iniziale

Prima della messa in uso, pulire il forno vuoto e impostare l'ora:			
			 00:00 Impostare l'ora. Premere OK .

6.2 Preriscaldamento iniziale

Preriscaldare il forno vuoto prima di utilizzarlo per la prima volta.	
Fase 1	Togliere gli accessori e i supporti ripiano amovibili dal forno.

Preriscaldare il forno vuoto prima di utilizzarlo per la prima volta.

Fase 2 Impostare la temperatura massima per la funzione: .
Lasciare in funzione il forno per un'ora.

Fase 3 Impostare la temperatura massima per la funzione: .
Lasciare in funzione il forno per 15 minuti.

 Il forno può produrre un odore sgradevole e fumo in fase di pre-riscaldamento. Accertarsi che la stanza sia ventilata.

6.3 Connessione wireless

Per collegare il forno sono necessari i seguenti elementi:

- Rete wireless con connessione a Internet.
- Dispositivo mobile connesso alla rete wireless.

Fase 1 Scaricare l'app mobile My AEG Kitchen e seguire le istruzioni per i passaggi successivi.

Pas-saggio 2 Ruotare la manopola per selezionare: .

Frequenza	WLAN 2,4 GHz	WLAN 5 GHz
		2400 - 2483,5 MHz
Protocollo	IEEE 802,11b DSSS, 802,11g/n OFDM	IEEE 802,11 a/n OFDM
Potenza massima	EIRP < 20 dBm (100 mW)	EIRP < 23 dBm (200 mW)
Modulo Wi-Fi	NIU5-50	

Frequenza Bluetooth	2400 - 2483,5 MHz
Protocollo	LE: DSSS
Potenza massima	EIRP < 4 dBm (2,5 mW)

Paesi coperti dalle disposizioni della Direttiva 2014/53/UE: Belgio, Bulgaria, Repubblica Ceca, Danimarca, Germania, Estonia, Irlanda, Grecia, Spagna, Francia, Croazia, Italia, Cipro,

UTILIZZO QUOTIDIANO

Lettonia, Lituania, Lussemburgo, Ungheria, Malta, Paesi Bassi, Irlanda del Nord, Austria, Polonia, Portogallo, Romania, Slovenia, Slovacchia, Finlandia, Svezia, Norvegia, Islanda, Liechtenstein, Svizzera, Turchia.

6.4 Licenze software

Il software di questo prodotto contiene componenti basati su software gratuiti e open source. AEG riconosce appieno il contributo delle comunità software e robotiche al progetto di sviluppo.

Per accedere al codice sorgente dei componenti software gratuiti e open source, le cui condizioni di licenza richiedono la pubblicazione, e per vedere le informazioni complete sul copyright oltre che i termini di licenza applicabili, visitare il sito: <http://aeg.opensourcerepository.com> (cartella NIU5).



7. UTILIZZO QUOTIDIANO







AVVERTENZA!

Fare riferimento ai capitoli sulla sicurezza.

7.1 Come impostare: Funzioni cottura







Avviare la cottura	
Passaggio 1	Fase 2
	
Imposta una funzione di cottura.	Impostare la temperatura.





Cottura a vapore				
Fase 1	Passaggio 2	Passaggio 3	Passaggio 4	Passaggio 5
				

Cottura a vapore				
Premere il coperchio della vaschetta dell'acqua per aprirlo.	Riempire la vaschetta dell'acqua con 900 ml di acqua.	Premere per riportare la vaschetta dell'acqua nella posizione iniziale.	Impostare la funzione di cottura a vapore.	Impostare la temperatura.

7.2 Funzioni cottura

Funzioni cottura standard

Funzione cottura	Applicazione
 Cottura ventilata	Per cuocere su massimo tre posizioni della griglia contemporaneamente ed essiccare i cibi. Impostare la temperatura di 20 - 40°C inferiore rispetto a Cottura convenzionale. .
 Cottura convenzionale	Per cuocere e arrostitire alimenti su una sola posizione del ripiano.
 Umidità bassa	La funzione è adatta per carne, pollame, pietanze al forno e sfornati. Con la combinazione del vapore e del calore, la carne acquisisce una consistenza morbida e succosa con una superficie croccante.
 Funzione Pizza	Per cuocere la pizza. Per una doratura intensa e una base croccante.
 Resistenza inferiore	Per dorare torte con base croccante e per conservare gli alimenti.
 Cibi congelati	Per rendere croccanti i cibi confezionati, come ad esempio patatine fritte, crocchette o involtini primavera.

Funzione cottura	Applicazione
 <p>Cottura ventilata umida</p>	<p>Questa funzione è progettata per il risparmio energetico durante la cottura. Quando viene usata questa funzione, la temperatura all'interno della cavità potrebbe essere diversa rispetto alla temperatura impostata. Viene utilizzato il calore residuo. La potenza riscaldante potrebbe essere ridotta. Per ulteriori informazioni, consultare il capitolo "Uso quotidiano", Note su: Cottura ventilata umida.</p>
 <p>Grill</p>	<p>Per grigliare alimenti di ridotto spessore e tostare il pane.</p>
 <p>Doppio grill ventilato</p>	<p>Per arrostitire grandi tagli di carne o pollame con ossa su una posizione della griglia. Per gratinare e dorare.</p>
 <p>Menu</p>	<p>Per accedere al Menu: Cottura guidata, Pulizia, Impostazioni.</p>

7.3 Note su: Cottura ventilata umida



Questa funzione è stata utilizzata per la conformità alla classe energetica e ai requisiti di ecodesign secondo la normativa UE 65/2014 e UE 66/2014. Test secondo la norma EN 60350-1.

La porta del forno dovrebbe essere chiusa in fase di cottura, in modo che la funzione non venga interrotta. Ciò garantisce inoltre che il forno funzioni con la più elevata efficienza energetica possibile.

Quando viene usata questa funzione, la lampada si spegne automaticamente dopo 30 secondi.

Per le istruzioni di cottura rimandiamo al capitolo "Consigli e suggerimenti", Cottura ventilata umida. Per indicazioni generali sul risparmio energetico rimandiamo al capitolo "Efficienza energetica", Risparmio energetico.

7.4 Serbatoio dell'acqua

Indicatore del serbatoio d'acqua	
	Il serbatoio è pieno.
	Il serbatoio è mezzo pieno.
	Il serbatoio è vuoto. Riempire nuovamente il serbatoio.

Indicatore del serbatoio d'acqua

Se si versa troppa acqua nel serbatoio, lo scarico di sicurezza fa defluire l'acqua in eccesso dal fondo della cavità. Togliere l'acqua con una spugna.

Svuotamento del serbatoio dell'acqua

Fase 1	Spegner il forno, lasciarlo con la porta aperta e attendere che sia freddo.	
Pas-saggio 2	Collegare il tubo di scarico (C) alla valvola di scarico (A) attraverso il connettore (B).	
Pas-saggio 3	Tenere l'estremità del tubo sotto il livello di A e premere ripetutamente B per raccogliere l'acqua restante.	
Pas-saggio 4	Staccare i filtri C e B e asciugare il forno con una spugna morbida.	

7.5 Come impostare: Cottura guidata

Ogni pietanza di questo sottomenu prevede funzione e temperatura consigliate. È possibile regolare l'ora e la temperatura in fase di cottura.

Alcune pietanze possono anche essere cucinate usando:	Il livello fino al quale viene cucinato un piatto:
<ul style="list-style-type: none"> • Termosonda 	<ul style="list-style-type: none"> • Al sangue • Medio • Ben cotto





Cottura guidata - utilizzare per preparare un piatto rapidamente con le impostazioni predefinite:

Fase 1	Passaggio 2	Passaggio 3	Passaggio 4
 	 	 1 - 45	 OK







Cottura guidata - utilizzare per preparare un piatto rapidamente con le impostazioni predefinite:









Accedere al menu.	Selezionare Cottura guidata. Premere OK.	Selezionare la pietanza. Premere OK.	Inserire la pietanza nel forno. Confermare l'impostazione.
-------------------	--	--------------------------------------	--

7.6 Cottura guidata con ricette

















Legenda	
	Termosonda disponibile. Posizionare la Termosonda nella parte più spessa del piatto. Il forno si spegne quando Termosonda viene raggiunta la temperatura impostata.
	Aggiungere acqua al serbatoio.
	Preriscaldare il forno prima di iniziare a cucinare.
	Livello del ripiano.























Al termine della funzione, controllare se il cibo è pronto.

	Piatto	Peso	Livello / Accessorio ripiano	Durata
Manzo 				
P1	Roast beef, al sangue	1 - 1,5 kg; pezzi spessi 4-5 cm	  2 lamiera dolci Friggere la carne per alcuni minuti in una padella calda. Informare.	~ 40 min
P2	Roast beef, cottura media			~ 50 min
P3	Roast beef, ben cotto			~ 60 min
P4	Bistecca, media cottura	180 - 220 g per pezzo; fette di 3 cm di spessore	   3; pirofila su ripiano a filo Friggere la carne per alcuni minuti in una padella calda. Informare.	~ 15 min























	Piatto	Peso	Livello / Accessorio ripiano	Durata
P5	Arrosto di manzo / brasato (costoletta, scamone, fesa)	1,5 - 2 kg	 2; pirofila su ripiano a filo Friggere la carne per alcuni minuti in una padella calda. Aggiungere liquido. Infornare.	~ 120 min
P6	Roast beef, al sangue (cottura lenta)	1 - 1,5 kg; pezzi spessi 4-5 cm	 2; lamiera dolci Utilizzare le spezie preferite o il semplice pepe macinato. Friggere la carne per alcuni minuti in una padella calda. Infornare.	~ 75 min
P7	Roast beef, cottura media (cottura lenta)			~ 85 min
P8	Roast beef, ben cotto (cottura lenta)			~ 130 min
P9	Filetto, al sangue (cottura lenta)	0,5 - 1,5 kg; pezzi spessi 5-6 cm	 2; teglia da forno Utilizzare le spezie preferite o il semplice pepe macinato. Friggere la carne per alcuni minuti in una padella calda. Infornare.	~ 75 min
P10	Filetto, cottura media (cottura lenta)			~ 90 min
P11	Filetto, cotto (cottura lenta)			~ 120 min
Vitello 				
P12	Arrosto di vitello (ad es. spalla)	0,8 - 1,5 kg; pezzi spessi 4 cm	 2; pirofila su ripiano a filo Utilizzare le spezie preferite. Aggiungere liquido. Arrosto coperto.	~ 80 min
Maiale  				
P13	Collo o spalla di maiale arrosto	1,5 - 2 kg	  1; pirofila su ripiano a filo Girare la carne a metà cottura.	~ 165 min





UTILIZZO QUOTIDIANO

	Piatto	Peso	Livello / Accessorio ripiano	Durata
P14	Maiale sfilacciato cotto a bassa temperatura	1,5 - 2 kg	  2; teglia da forno Utilizzare le spezie preferite. Girare la carne a metà cottura per ottenere una doratura uniforme.	~ 215 min
P15	Lombo, fresco	1 - 1,5 kg; pezzi spessi 5-6 cm	  2; pirofila su ripiano a filo Utilizzare le spezie preferite.	~ 55 min
P16	Costolette di maiale	2 - 3 kg; utilizzare puntine crude, 2 - 3 cm	 3; leccarda Aggiungere il liquido per coprire il fondo di un piatto. Girare la carne a metà cottura.	90 min.
Agnello 				
P17	Cosciotto d'agnello con ossa	1,5 - 2 kg; 7 - 9 cm di spessore	  2 pirofila su lamiera dolci Aggiungere liquido. Girare la carne a metà cottura.	~ 130 min
Pollame 				
P18	Pollo intero	1 - 1,5 kg; fresco	  2 casseruola su lamiera dolci Utilizzare le spezie preferite. Girare il pollo a metà cottura per ottenere una doratura uniforme.	~ 60 min.
P19	Mezzo pollo	0,5 - 0,8 kg	  3; lamiera dolci Utilizzare le spezie preferite.	~ 40 min
P20	Pollo, petto	180 - 200 g per pezzo	  2 casseruola su ripiano a filo Utilizzare le spezie preferite. Friggere la carne per alcuni minuti in una padella calda.	~ 25 min
P21	Cosce di pollo, fresche	-	  3; lamiera dolci Se le cosce di pollo sono state marinate prima, impostare la temperatura più bassa e cuocerle più a lungo.	~ 30 min

	Piatto	Peso	Livello / Accessorio ripiano	Durata
P22	Anatra, intera	2 - 3 kg	  2; pirofila su ripiano a filo Utilizzare le spezie preferite. Sistemare la carne sulla teglia. Girare l'anatra a metà cottura.	~ 100 min
P23	Oca, intera	4 - 5 kg	  2; leccarda Utilizzare le spezie preferite. Sistemare la carne su una teglia da forno profonda. Girare l'oca a metà cottura.	~ 110 min
Altro 				
P24	Polpettone	1 kg	  2; ripiano a filo Utilizzare le spezie preferite.	~ 60 min
 Pesce				
P25	Pesce intero, grigliato	0,5 - 1 kg per pesce	  2 ; lamiera dolci Farcire il pesce con burro e utilizzare spezie ed erbe preferite.	~ 30 min
P26	Filetto di pesce	-	  3 casseruola su ripiano a filo Utilizzare le spezie preferite.	35 min
Dolci da forno / dessert   				
P27	Cheesecake	-	 2;  Tortiera apribile da 28 cm su ripiano a filo	90 min.
P28	Torta di mele	-	 3; lamiera dolci	45 min
P29	Crostata di mele	-	 2; tortiera su ripiano a filo	40 min
P30	Torta di mele americana	-	 1;  tortiera da 22 cm su ripiano a filo	60 min
P31	Brownies	2 kg	 3 leccarda	30 min





UTILIZZO QUOTIDIANO

	Piatto	Peso	Livello / Accessorio ripiano	Durata
P32	Muffin al cioccolato	-	 3, vassoio muffin su ripiano a filo	25 min
P33	Torta di pane	-	 2 leccarda su ripiano a filo	50 min
Verdure / Contorni   				
P34	Patate al forno	1 kg	 2; lamiera dolci Mettere le patate intere con buccia sulla lamiera dolci.	50 min
P35	Spicchi	1 kg	 3 lamiera dolci rivestita con carta da forno Utilizzare le spezie preferite. Tagliare le patate a pezzi.	35 min
P36	Verdure miste grigliate	1 - 1,5 kg	 3 lamiera dolci rivestita con carta da forno Utilizzare le spezie preferite. Tagliare le verdure a pezzi.	30 min
P37	Crocchette, surgelate	0,5 kg	 3; lamiera dolci	25 min
P38	Patatine, surgelate	0,75 kg	 3; lamiera dolci	25 min
Gratin, pane e pizza   				
P39	Lasagne / sformato di spaghetti	1 - 1,5 kg	  2 casseruola su ripiano a filo	55 min
P40	Patate gratinate	1 - 1,5 kg	  1 casseruola su ripiano a filo	60 min
P41	Pizza fresca, sottile	-	   2 lamiera dolci rivestita con carta da forno	35 min
P42	Pizza fresca, spessa	-	  2 lamiera dolci rivestita con carta da forno	25 min



	Piatto	Peso	Livello / Accessorio ripiano	Durata
P43	Quiche	-	 2; teglia da forno su ripiano a filo	45 min
P44	Baguette / Ciabatta / Pane bianco	0,8 kg	  2 lamiera dolci rivestita con carta da forno Più tempo necessario per il pane bianco.	50 min
P45	Impasto per pane integrale / pane di segale /pane nero in uno stampo per pane	1 kg	  2 lamiera dolci rivestita con carta da forno / ripiano a filo	60 min

8. FUNZIONI DEL TIMER

8.1 Funzioni orologio

Funzione Orologio	Applicazione
	Contaminuti. Allo scadere del tempo, viene emesso un segnale acustico.
	Tempo di cottura. Quando il timer arriva alla fine, si sente un segnale e la funzione cottura si ferma.
	Ritardo. Per posticipare l'inizio e/o la fine della cottura.
	Timer. Il massimo è 23 ore 59 min. Questa funzione non ha nessun effetto sul funzionamento del forno. Per accendere e spegnere Timer selezionare: Menu, Impostazioni.

8.2 Come impostare: Funzioni Orologio





Come impostare: Imposta ora		
Fase 1	Passaggio 2	Fase 3
		

FUNZIONI DEL TIMER

Come impostare: Imposta ora







Per modificare l'ora, accedere al menu e selezionare Impostazioni, Ora.	Impostare l'orologio.	Premere: OK.
---	-----------------------	--------------

Come impostare: Contaminuti









Fase 1	Il display visualizza: 0:00 	Passaggio 2	Passaggio 3
			
Premere: 		Imposta Contaminuti	Premere: OK.

 Il timer inizia subito il conto alla rovescia.

Come impostare: Tempo di cottura

Fase 1	Fase 2	Il display visualizza: 0:00  STOP	Passaggio 3	Passaggio 4
				
Selezionare una funzione di cottura e impostare la temperatura.	Premere ripetutamente: 		Impostare la durata della cottura.	Premere: OK.

 Il timer inizia subito il conto alla rovescia.

Come impostare: Ritardo							
Fase 1	Fase 2		Passaggio 3	Passaggio 4		Passaggio 5	Passaggio 6
		Il display mostra: l'ora del giorno  START			Il display visualizza: --:--  STOP		
Selezio- nare la funzio- ne ri- scalda- mento.	Premere ripetuta- mente: 		Imposta- re l'orario di inizio.	Premere: OK.		Imposta- re l'ora- rio di fine.	Preme- re: OK.
 Il timer inizia il conto alla rovescia a un orario di inizio impostato.							

9. COME USARLE: ACCESSORI

9.1 Inserimento di accessori

Un piccolo rientro sulla parte superiore aumenta il livello di sicurezza. Gli incavi sono anche dispositivi antiribaltamento. Il bordo alto intorno al ripiano evita che pentole e padelle scivolino dal ripiano.

Ripiano a filo:

Spingere il ripiano fra le guide del supporto e verificare che i piedini siano rivolti verso il basso.

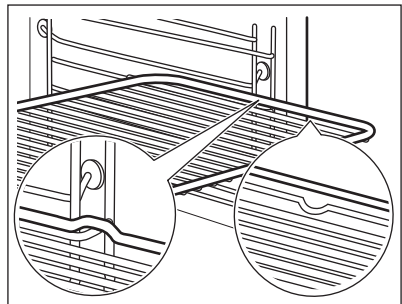

COME USARLE: ACCESSORI

Lamiera dolci / Teglia profonda:

Spingere la lamiera tra le guide del supporto ripiano.

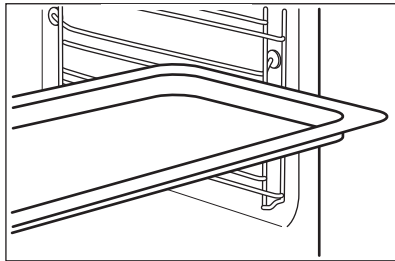

Ripiano a filo, Lamiera dolci / Teglia profonda:

Spingere il vassoio tra le guide del supporto ripiano e il ripiano a filo sulle guide sovrastanti.

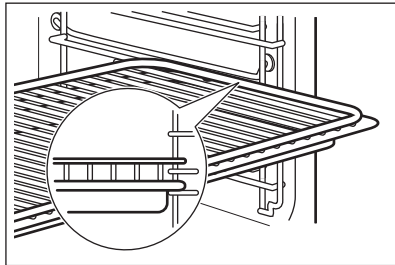

9.2 Termosonda

Termosonda- misura la temperatura all'interno del cibo.

Le temperature da impostare sono due:



La temperatura del forno.



La temperatura interna.

Per i migliori risultati di cottura:



Gli ingredienti dovrebbero essere a temperatura ambiente.

Non usarlo per pietanze liquide.

Durante la cottura deve rimanere nel piatto.

Istruzioni d'uso: Termosonda

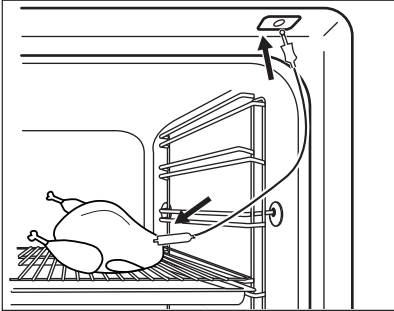
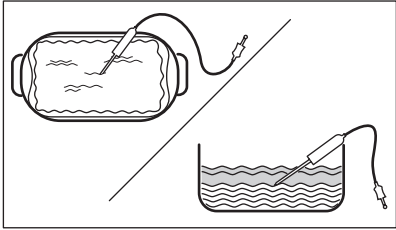
Fase 1	Accendere il forno.
Pas-saggio 2	Impostare una funzione cottura e, se necessario, la temperatura del forno.

<p>Pas-saggio 3</p>	<p>Inserire: Termosonda.</p>
<p>Carne, pollame e pesce</p>	<p>Sformato</p>
<p>Inserire la punta della Termosonda al centro della carne, del pesce nella parte più spessa, ove possibile. Assicurarsi che almeno 3/4 di Termosonda sia inserita all'interno della pietanza.</p>	<p>Inserire la punta di Termosonda esattamente al centro dello sformato. Il Termosonda dovrebbe essere stabilizzato in un punto in fase di cottura. Utilizzare un ingrediente solido per ottenere questo risultato. Utilizzare il bordo della teglia per supportare la maniglia in silicone di Termosonda. La punta di Termosonda non dovrebbe toccare il fondo di una teglia.</p>
	
<p>Pas-saggio 4</p>	<p>Collegare la Termosonda nella presa sulla parte anteriore del forno. Sul display appare la temperatura attuale di: Termosonda.</p>
<p>Pas-saggio 5</p>	<p> - premere per impostare la temperatura al cuore del sensore.</p>
<p>Pas-saggio 6</p>	<p>OK- premere per confermare. Quando il cibo raggiunge la temperatura impostata, viene emesso un segnale acustico. Si può scegliere se arrestare la cottura o continuarla per essere sicuri che l'alimento sia ben cotto.</p>
<p>Pas-saggio 7</p>	<p>Estrarre la spina di Termosonda dalla presa e rimuovere la pietanza dal forno.</p> <div style="border: 1px solid black; padding: 5px;"> <p> AVVERTENZA! Vi è il rischio di ustioni, in quanto il Termosonda si surriscalda. Fare attenzione in fase di rimozione ed estrazione dalla pietanza.</p> </div>

10. FUNZIONI AGGIUNTIVE

10.1 Blocco

Questa funzione evita che si cambi per sbaglio la funzione forno.



Attivarla quando il forno è in funzione: la cottura impostata continua, il pannello dei comandi è bloccato.

Attivarla quando il forno è spento - il forno non può essere acceso, il pannello dei comandi è bloccato.





 OK - tenere premuto per attivare la funzione. Viene emesso un segnale acustico.

 OK - premere e tenere premuto per disattivarla.

 3 x  - lampeggia quando il blocco è attivato.

10.2 Spegnimento automatico

Per ragioni di sicurezza, il forno si spegne dopo un determinato periodo di tempo se è attiva una funzione di riscaldamento e non si modificano le impostazioni.

 (°C)	 (h)
30 - 115	12.5
120 - 195	8.5
200 - 245	5.5
250 - massimo	3

Lo spegnimento automatico non funziona con le funzioni: Luce forno, Termosonda, Ritardo.

10.3 Ventola di raffreddamento





Quando il forno è in funzione, la ventola di raffreddamento si accende in modo automatico per tenere fresche le superfici del forno. Dopo aver spento il forno, la ventola di raffreddamento potrebbe continuare a funzionare fino a che il forno non si è raffreddato.

11. CONSIGLI E SUGGERIMENTI UTILI





11.1 Cottura ventilata umida

Per ottenere i risultati migliori, attenersi ai suggerimenti elencati nella tabella sottostante.

CONSIGLI E SUGGERIMENTI UTILI



		 (°C)		 (min.)
Roll dolci, 16 pezzi	vassoio di cottura o leccarda	180	2	20 - 30
Panini, 9 pezzi	vassoio di cottura o leccarda	180	2	30 - 40
Pizza, surgelata, 0,35 kg	ripiano a filo	220	2	10 - 15
Rotolo con marmellata	vassoio di cottura o leccarda	170	2	25 - 35
Brownie	vassoio di cottura o leccarda	175	3	25 - 30
Soufflé, 6 pezzi	stampini di ceramica sulla griglia	200	3	25 - 30
Base pan di spagna	teglia per timballo su griglia	180	2	15 - 25
Pasticcini per il tè	piatto da forno su griglia	170	2	40 - 50
Pesce lesso, 0,3 kg	vassoio di cottura o leccarda	180	3	20 - 25
Pesce intero, 0,2 kg	vassoio di cottura o leccarda	180	3	25 - 35
Filetto di pesce, 0,3 kg	teglia per pizza su griglia	180	3	25 - 30
Carne lessa, 0,25 kg	vassoio di cottura o leccarda	200	3	35 - 45
Shashlik, 0,5 kg	vassoio di cottura o leccarda	200	3	25 - 30
Dolcetti, 16 pezzi	vassoio di cottura o leccarda	180	2	20 - 30

CONSIGLI E SUGGERIMENTI UTILI

		 (°C)		 (min.)
Meringhe, 24 pezzi	vassoio di cottura o leccarda	180	2	25 - 35
Muffin, 12 pezzi	vassoio di cottura o leccarda	170	2	30 - 40
Pasta saporita, 20 pezzi	vassoio di cottura o leccarda	180	2	25 - 30
Biscotti di pasta frolla, 20 pezzi	vassoio di cottura o leccarda	150	2	25 - 35
Tartellette, 8 pezzi	vassoio di cottura o leccarda	170	2	20 - 30
Verdure, lesse, 0,4 kg	vassoio di cottura o leccarda	180	3	35 - 45
Omelette vegetariana	teglia per pizza su griglia	200	3	25 - 30
Verdure alla mediterranea, 0,7 kg	vassoio di cottura o leccarda	180	4	25 - 30

11.2 Cottura ventilata umida - accessori consigliati

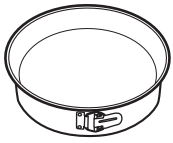

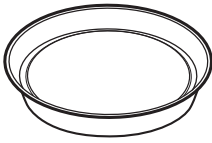



Usare scatole e contenitori scuri e non riflettenti. Assorbono meglio il calore rispetto al colore chiaro e ai piatti riflettenti.

			
Teglia da pizza	Pirofila	Pirofile monoporzione	Tortiera per flan
Scura, non riflettente 28 cm di diametro	Scura, non riflettente 26 cm di diametro	Ceramica diametro 8 cm, altezza 5 cm	Scura, non riflettente 28 cm di diametro







11.3 Tabelle di cottura per gli istituti di test

Informazioni per gli istituti di test

Test in conformità alla norma IEC 60350-1.

				 (°C)	 (min.)	
Tortine, 20 per teglia	Cottura convenzio- nale	Lamiera dolci	3	170	20 - 30	-
Tortine, 20 per teglia	Cottura ventilata	Lamiera dolci	3	150 - 160	20 - 35	-
Tortine, 20 per teglia	Cottura ventilata	Lamiera dolci	2 e 4	150 - 160	20 - 35	-
Torta di mele america- na, 2 stampi Ø20 cm	Cottura convenzio- nale	Ripiano a filo	2	180	70 - 90	-
Torta di mele america- na, 2 stampi Ø20 cm	Cottura ventilata	Ripiano a filo	2	160	70 - 90	-
Pan di Spagna, stampo per torta Ø26 cm	Cottura convenzio- nale	Ripiano a filo	2	170	40 - 50	Preriscaldare il forno per 10 minu- ti.
Pan di Spagna, stampo per torta Ø26 cm	Cottura ventilata	Ripiano a filo	2	160	40 - 50	Preriscaldare il forno per 10 minu- ti.

PULIZIA E CURA

				 (°C)	 (min.)	
Pan di Spagna, stampo per torta Ø26 cm	Cottura ventilata	Ripiano a filo	2 e 4	160	40 - 60	Preriscaldare il forno per 10 minuti.
Frollini al burro	Cottura ventilata	Lamiera dolci	3	140 - 150	20 - 40	-
Frollini al burro	Cottura ventilata	Lamiera dolci	2 e 4	140 - 150	25 - 45	-
Frollini al burro	Cottura convenzionale	Lamiera dolci	3	140 - 150	25 - 45	-
Toast, 4 - 6 pezzi	Grill	Ripiano a filo	4	max	2 - 3 minuti sul primo lato; 2 - 3 minuti sul secondo lato	Preriscaldare il forno per 3 minuti.
Hamburger di manzo, 6 pezzi, 0,6 kg	Grill	Su ripiano a filo e leccarda	4	max	20 - 30	Sistemare il ripiano a filo sul quarto livello e la leccarda sul terzo livello del forno. A metà cottura girare gli alimenti. Preriscaldare il forno per 3 minuti.



12. PULIZIA E CURA



AVVERTENZA!

Fare riferimento ai capitoli sulla sicurezza.

12.1 Note sulla pulizia

 Agenti di pulizia	<p>Pulire la parte anteriore del forno con un panno morbido imbevuto di acqua tiepida e detergente delicato.</p>
	<p>Servirsi di una soluzione detergente per pulire le superfici metalliche.</p>
	<p>Pulire le macchie con un detergente delicato.</p>
 Uso quotidiano	<p>Pulire la cavità dopo ogni utilizzo. L'accumulo di grasso o di altri residui potrebbe causare un incendio.</p>
	<p>L'umidità può formare condensa nel forno o sui pannelli di vetro dello sportello. Per ridurre la condensa, mettere in funzione il forno 10 minuti prima di iniziare a cucinare. Non lasciare le vivande nel forno per più di 20 minuti. Asciugare la cavità con un panno morbido dopo ogni uso.</p>
 Accessori	<p>Pulire tutti gli accessori dopo ogni uso e lasciarli asciugare. Utilizzare un panno morbido imbevuto di acqua tiepida e un detergente delicato. Non pulire gli accessori in lavastoviglie.</p>
	<p>Non pulire gli accessori anti-aderenti con agenti abrasivi o oggetti appuntiti.</p>

12.2 Come togliere: Supporti ripiano

Rimuovere i supporti ripiano per pulire il forno.

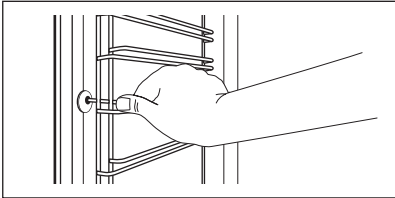
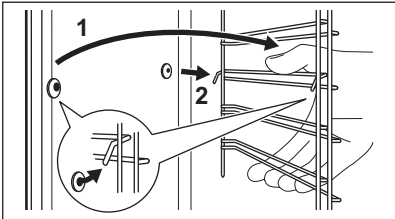
Fase 1	Spegnere il forno e attendere che sia freddo.	
Fase 2	Sfilare dapprima la guida di estrazione dalla parete laterale tirandola in avanti.	
Fase 3	Sfilare la guida di estrazione posteriore dalla parete laterale e toglierla.	
Fase 4	Installare i supporti griglia seguendo al contrario la procedura indicata.	

12.3 Istruzioni d'uso: Pulizia per pirolisi

Pulire il forno con Pulizia per pirolisi.



AVVERTENZA!

Rischio di ustioni.





ATTENZIONE!

Se nello stesso armadietto sono installate altre apparecchiature, non utilizzarle allo stesso tempo di questa funzione. Il forno potrebbe subire danni.

Prima della Pulizia per pirolisi:

Spegnere il forno e attendere che si raffreddi.	Rimuovere tutti gli accessori.	Pulire la base del forno e il vetro interno dello sportello con acqua calda, un panno morbido e un detergente delicato.
---	--------------------------------	---

Pulizia per pirolisi

Fase 1	Accedere al menu: Pulizia  .	
	Opzione	Durata
	C1 - Pulizia leggera	1 h
	C2 - Pulizia normale	1 h 30 min
	C3 - Pulizia completa	2 h 30 min
Passaggio 2	OK - premere per selezionare il programma di pulizia.	
Passaggio 3	OK - premere per avviare la pulizia.	
Passaggio 4	Dopo la pulizia, ruotare la manopola delle funzioni di cottura sulla posizione di spento.	
 Durante la pulizia la lampadina del forno è spenta.		
Quando il forno raggiunge la temperatura impostata, lo sportello si blocca. Finché lo sportello non si sblocca il display indica:  .		

Al termine della pulizia:

Spegnere il forno e attendere che si raffreddi.	Pulire la cavità con un panno morbido.	Rimuovere il residuo dal basso della cavità.
---	--	--

12.4 Promemoria Pulizia

Il forno vi ricorda quando pulirlo con la pulizia pirolitica.

 lampeggia sul display per 5 secondi dopo ogni sessione di cottura.	Per disattivare il promemoria inserire il Menu e selezionare Impostazioni, Promemoria Pulizia.
--	--

12.5 Come eseguire la pulizia: Serbatoio dell'acqua

Fase 1	Spegnere il forno.
Pas-saggio 2	Collocare una leccarda sotto al foro di entrata vapore.
Pas-saggio 3	Versare acqua nella vaschetta: 850 ml. Aggiungere l'acido citrico: 5 cucchiaini. Attendere 60 minuti.
Pas-saggio 4	Attivare il forno e impostare la funzione: Umidità bassa. Impostare la temperatura a 230 °C. Spegnere il forno dopo 25 minuti e attendere che si raffreddi.
Pas-saggio 5	Attivare il forno e impostare la funzione: Umidità bassa. Impostare una temperatura tra 130 e 230°C. Spegnere il forno dopo 10 minuti e attendere che si raffreddi.
 Per evitare residui di calcare, svuotare il serbatoio dell'acqua dopo ogni cottura a vapore.	

Al termine della pulizia:

Spegnere il forno.	Svuotare il serbatoio dell'acqua. Fare riferimento al capitolo Uso quotidiano, "Svuotamento del serbatoio dell'acqua".	Sciagquare il serbatoio dell'acqua ed eliminare i residui di calcare rimanenti con un panno morbido.	Pulire il tubo di scarico con acqua tiepida e detergente delicato.
--------------------	--	--	--

La tabella seguente mostra il valore di durezza dell'acqua (dH) con il corrispondente livello di deposito di calcio e la qualità dell'acqua. Quando la durezza dell'acqua supera il livello 4, riempire la vaschetta con acqua in bottiglia.

Durezza dell'acqua		Striscia di prova	Deposito di calcio (mg/l)	Classificazione dell'acqua	Pulire il serbatoio dell'acqua ogni
Livello	Dh				
1	0 - 7		0 - 50	dolce	75 cicli - 2,5 mesi
2	8 - 14		51 - 100	moderatam. dura	50 cicli - 2 mesi
3	15 - 21		101 - 150	dura	40 cicli - 1,5 mesi
4	22 - 28		oltre 151	molto dura	30 cicli - 1 mese

12.6 Come rimuovere e installare: Porta

La porta del forno è dotata di tre pannelli in vetro. È possibile rimuovere la porta ed i pannelli interni in vetro per pulirli. Leggere tutte le istruzioni "Rimozione e installazione della porta" prima di togliere i pannelli in vetro.



ATTENZIONE!

Non utilizzare il forno senza i pannelli in vetro.

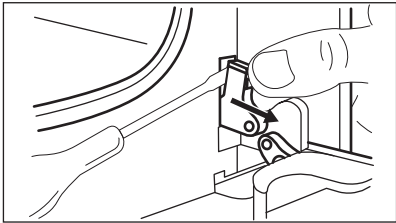
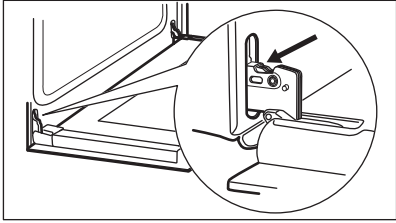
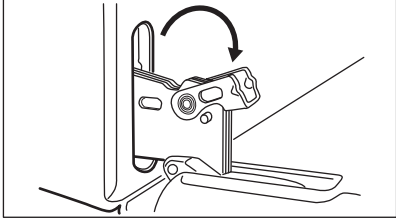
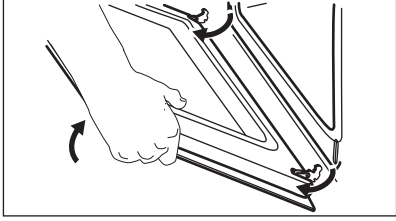
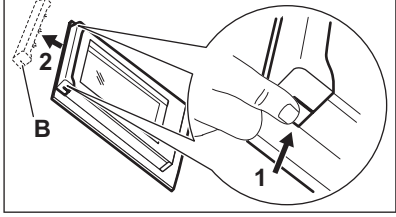
<p>Fase 1</p>	<p>Aprire completamente la porta e individuare la cerniera sul lato destro della stessa.</p>	
<p>Fase 2</p>	<p>Usare un cacciavite per sollevare e ruotare completamente il lato cerniera del lato destro.</p>	
<p>Fase 3</p>	<p>Individuare la cerniera sul lato sinistro della porta.</p>	
<p>Fase 4</p>	<p>Alzare e ruotare la leva completamente sulla cerniera sinistra.</p>	
<p>Fase 5</p>	<p>Chiudere la porta del forno fino alla prima posizione di apertura circa metà. Quindi sollevare e tirare in avanti la porta sfilandola dalla sua sede.</p>	
<p>Fase 6</p>	<p>Appoggiare la porta su una superficie stabile e coperta da un panno morbido.</p>	
<p>Fase 7</p>	<p>Afferrare sui due lati la guida della porta (B) sul bordo superiore della stessa e premere verso l'interno per rilasciare la chiusura a scatto.</p>	
<p>Fase 8</p>	<p>Rimuovere la copertura tirandola in avanti</p>	
<p>Fase 9</p>	<p>Tenere i pannelli in vetro della porta per l'estremità superiore ed estrarli con attenzione, uno alla volta. Iniziare dal pannello superiore. Verificare che il vetro scorra completamente fino a uscire dai supporti.</p>	

PULIZIA E CURA

<p>Fase 10</p>	<p>Pulire il pannello di vetro con dell'acqua saponata. Asciugare i pannelli di vetro facendo attenzione. Non pulire i pannelli in vetro in lavastoviglie.</p>	
<p>Fase 11</p>	<p>Al termine della pulizia, installare i pannelli in vetro e la porta del forno.</p>	

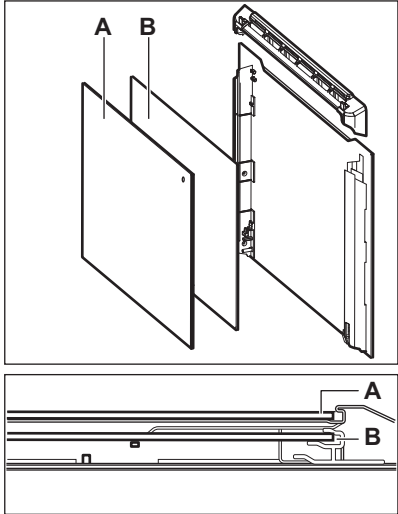
<p>Assicurarsi di rimontare i pannelli in vetro (A e B) nell'ordine esatto. Controllare il simbolo / la stampa sul lato del pannello in vetro, ciascuno dei pannelli in vetro è diverso per semplificare le operazioni di smontaggio e montaggio.</p> <p>Se installato correttamente, il profilo della porta emette un clic.</p> <p>Accertarsi di installare il pannello intermedio in vetro nelle sedi corrette.</p>	
---	---

12.7 Come sostituire: Lampadina

	<p>AVVERTENZA! Pericolo di scosse elettriche. La lampada potrebbe essere calda.</p>
--	--

Tenere sempre la lampadina alogena con uno straccio, per evitare che dei residui di grasso vi brucino sopra.

Prima di sostituire la lampadina:		
Fase 1	Fase 2	Fase 3
<p>Spegnere il forno. Attendere che il forno sia freddo.</p>	<p>Estrarre la spina dalla presa di corrente.</p>	<p>Appoggiare un panno sul fondo della cavità.</p>

Lampadina posteriore

Fase 1	Girare il rivestimento di vetro per toglierlo.
Fase 2	Pulire il rivestimento di vetro.
Fase 3	Sostituire la lampadina con una adatta, termoresistente fino a 300 °C.
Fase 4	Installare la calotta di vetro.

13. RISOLUZIONE DEI PROBLEMI



AVVERTENZA!

Fare riferimento ai capitoli sulla sicurezza.

13.1 Cosa fare se...



Per tutti i casi non inclusi in questa tabella si prega di contattare un Centro di assistenza autorizzato.

Il forno non si accende o non riscalda	
Problema	Controllare se...
Non è possibile attivare il forno o metterlo in funzione.	Il forno è stato collegato correttamente all'alimentazione di rete.
Il forno non scalda.	Lo spegnimento automatico è disattivo.
Il forno non scalda.	La porta del forno è chiusa.
Il forno non scalda.	È saltato il fusibile.
Il forno non scalda.	La Sicurezza bambini è disattivata.

Componenti	
Problema	Controllare se...
La spia è spenta.	Cottura ventilata umida - è acceso.
La lampadina non funziona.	La lampadina è bruciata.
La Termosonda non funziona.	La spina della Termosonda è completamente inserita nella presa.

RISOLUZIONE DEI PROBLEMI

Codici di errore	
Il display visualizza...	Controllare se...
Err C2	È stata staccata la Termosonda spina dalla presa di corrente.
Err C3	La porta del forno è chiusa o il blocco della porta non è rotto.
Err F102	La porta del forno è chiusa.
Err F102	Il blocco della porta non è rotto.
00:00	Si è verificata un'interruzione dell'alimentazione elettrica. Impostare l'ora.
Il display mostra un codice di errore non presente nella tabella. Disattivare e riattivare il fusibile domestico e riavviare il forno. In caso di ricomparsa del codice di errore, contattare il Centro di assistenza autorizzato.	

Pulizia	
Problema	Controllare se...
È presente dell'acqua all'interno della goffratu- ra del forno.	La quantità di acqua nel serbatoio è insufficien- te.
 - la spia è spenta.	La quantità di acqua nel serbatoio è sufficiente. Se si verificano delle perdite di acqua nel forno e la spia resta spenta, contattare un Centro di assistenza autorizzato.
 - la spia è accesa.	Il serbatoio contiene una quantità sufficiente di acqua. Se il serbatoio è pieno e la spia resta accesa, contattare un Centro di assistenza au- torizzato.
La cottura a vapore non funziona.	Non vi sono residui di calcare nel foro di entra- ta del vapore.
La cottura a vapore non funziona.	L'acqua è presente nel serbatoio.
Per svuotare il serbatoio dell'acqua o per il ve- rificarsi di acqua dall'apertura di entrata del va- pore occorrono più di tre minuti.	Non vi sono residui di calcare nel foro di entra- ta del vapore. Pulire il serbatoio dell'acqua.

13.2 Dati dell'Assistenza

Qualora non sia possibile trovare una soluzione al problema, contattare il rivenditore o un Centro di assistenza autorizzato.

Le informazioni necessarie per il Centro Assistenza si trovano sulla targhetta dei dati. La targhetta si trova sul telaio anteriore della cavità del forno. Non rimuovere la targhetta dei dati dalla cavità del forno.

Consigliamo di annotare i dati qui:	
Modello (Mod.)
Codice prodotto (PNC)
Numero di serie (S.N.)

14. EFFICIENZA ENERGETICA

14.1 Informazioni sul prodotto e Scheda informativa sul prodotto*

Nome fornitore	AEG
Identificativo modello	BSB578270M 949494787 BSE578270M 949494772 BSS57807BM 949494790 BSS578270M 949494786
Indice di efficienza energetica	81.2
Classe di efficienza energetica	A+
Consumo di energia con un carico standard, in modalità tradizionale	0.93 kWh/ciclo
Consumo di energia con un carico standard, in modalità ventola forzata	0.69 kWh/ciclo
Numero di cavità	1
Fonte di calore	Elettricità
Volume	72 l
Tipo di forno	Forno a incasso

Massa	BSB578270M	33.7 kg
	BSE578270M	32.9 kg
	BSS57807BM	34.8 kg
	BSS578270M	33.8 kg

* Per l'Unione europea secondo i regolamenti UE 65/2014 e 66/2014.
 Per la Repubblica di Bielorussia ai sensi di STB 2478-2017, appendice G; STB 2477-2017, allegati A e B.
 Per l'Ucraina secondo 568/32020.

La classe di efficienza energetica non è applicabile alla Russia.

EN 60350-1 - Apparecchiature elettriche per la cottura per uso domestico - Parte 1: Cucine, forni, forni a vapore e grill - Metodi per la misura delle prestazioni.

14.2 Risparmio energetico



Il forno è dotato di funzioni che contribuiscono al risparmio energetico durante le operazioni di cottura di tutti i giorni.

Verificare che la porta del forno sia chiusa quando lo stesso è in funzione. Non aprire la porta del forno con eccessiva frequenza in fase di cottura. Tenere pulita la guarnizione della porta e assicurarsi che sia ben fissata nella posizione corretta.

Servirsi di pentole in metallo per migliorare il risparmio energetico .

Ove possibile, non pre-riscaldare il forno prima della cottura.

Ridurre quanto più possibile gli intervalli fra le diverse operazioni di cottura quando vengono preparati più piatti contemporaneamente.

Cucinare con ventola

Ove possibile, servirsi delle funzioni di cottura con la ventola per risparmiare energia.

Calore residuo

La ventola e la lampada continuano a funzionare. Quando si spegne il forno, il display visualizza il calore residuo. Si può usare quel calore per mantenere le pietanze in caldo.

Quando la durata di cottura è superiore ai 30 minuti, ridurre la temperatura del forno al minimo 3-10 minuti prima della fine del processo di cottura. La cottura proseguirà grazie al calore residuo all'interno del forno.

Utilizzare il calore residuo per scaldare altri piatti.

Tenere in caldo gli alimenti

Scegliere l'impostazione di temperatura più bassa per sfruttare il calore residuo e mantenere calda la pietanza. La spia di calore residuo o la temperatura compaiono sul display.

Cottura con lampada spenta

Spegnere la lampada in fase di cottura. Accenderla solo quando è necessario.



Cottura ventilata umida

Funzione progettata per risparmiare energia in fase di cottura.



Quando si utilizza questa funzione, la lampadina si spegne automaticamente dopo 30 secondi. È possibile riaccendere la lampada, ma questa azione ridurrà i risparmi energetici previsti.







15. STRUTTURA DEL MENU

15.1 Menu

	 - selezionare per accedere alla Menu.
---	---

Menu struttura

Cottura guidata 	Pulizia 	Impostazioni 
---	---	--



Fase 1	Passaggio 2	Passaggio 3	Passaggio 4	Passaggio 5
 	 OK	 O1 - O15	 OK	
Selezionare il Menu, Impostazioni.	Confermare l'impostazione.	Selezionare l'impostazione.	Confermare l'impostazione.	Regolare il valore e premere OK.

Impostazioni

O1	Imposta ora	Modifica	O2	Luminosità	1 - 5
O3	Volume toni	1 - Bip 2 - Fare clic 3 - Segnale acustico spento	O4	Volume acustico	1 - 4
O5	Termosonda Azione	1 - Allarme e arresto 2 - Allarme	O6	Timer	On/Off
O7	Luce forno	On/Off	O8	Riscaldamento rapido	On/Off
O9	Promemoria Pulizia	On/Off	O10	Wi-Fi	On/Off

Impostazioni					
O11	Funzionamento con telecomando	On/Off	O12	Ignorare rete	Si / No
O13	Modalità demo	Codice di attivazione: 2468	O14	Versione software	Controllare
O15	Ripristino impostazioni iniziali di fabbrica	Si / No			

16. CONSIDERAZIONI SULL'AMBIENTE

Riciclare i materiali con il simbolo . Buttare l'imballaggio negli appositi contenitori per il riciclaggio. Aiutare a proteggere l'ambiente e la salute umana e a riciclare rifiuti derivanti da apparecchiature elettriche ed elettroniche. Non smaltire le apparecchiature che riportano il simbolo  insieme ai normali rifiuti domestici. Portare il prodotto al punto di riciclaggio più vicino o contattare il comune di residenza.

www.aeg.com/shop



867360533-C-302021

AEG

Free Manuals Download Website

<http://myh66.com>

<http://usermanuals.us>

<http://www.somanuals.com>

<http://www.4manuals.cc>

<http://www.manual-lib.com>

<http://www.404manual.com>

<http://www.luxmanual.com>

<http://aubethermostatmanual.com>

Golf course search by state

<http://golfingnear.com>

Email search by domain

<http://emailbydomain.com>

Auto manuals search

<http://auto.somanuals.com>

TV manuals search

<http://tv.somanuals.com>